

# Envision Stockton 2040 General Plan Update and Utility Master Plan Supplements Final EIR and Mitigation Monitoring and Reporting Program



OCTOBER 10, 2018

FINAL EIR AND MITIGATION MONITORING AND REPORTING PROGRAM





# Envision Stockton 2040 General Plan Update and Utility Master Plan Supplements Final EIR and Mitigation Monitoring and Reporting Program

OCTOBER 10, 2018

FINAL EIR AND MITIGATION MONITORING AND  
REPORTING PROGRAM

Prepared By:



1625 Shattuck Avenue, Suite 300  
Berkeley, California 94709  
510.848.3815

In Association With:

**Fehr & Peers Transportation Consultants**  
**BAE Urban Economics**  
**West Yost Associates**  
**Tom Origer & Associates**



# Table of Contents

---

|     |   |      |
|-----|---|------|
| 1.  | INTRODUCTION .....                                | 1-1  |
| 1.1 | Purpose of the Environmental Impact Report.....   | 1-1  |
| 1.2 | Environmental Review Process .....                | 1-1  |
| 1.3 | Document Organization.....                        | 1-2  |
| 2.  | REPORT SUMMARY .....                              | 2-1  |
| 2.1 | Environmental Procedures .....                    | 2-1  |
| 2.2 | Summary of the Proposed Project .....             | 2-3  |
| 2.3 | Summary of Project Alternatives .....             | 2-4  |
| 2.4 | Issues to be Resolved .....                       | 2-4  |
| 2.5 | Areas of Concern .....                            | 2-5  |
| 2.6 | Significant Impacts and Mitigation Measures ..... | 2-5  |
| 3.  | REVISIONS TO THE DRAFT EIR .....                  | 3-1  |
| 4.  | LIST OF COMMENTERS .....                          | 4-1  |
| 4.1 | Agencies and Organizations .....                  | 4-1  |
| 4.2 | Members of the Public .....                       | 4-1  |
| 4.3 | Public Hearing .....                              | 4-2  |
| 5.  | COMMENTS AND RESPONSES .....                      | 5-1  |
| 5.1 | Master Responses .....                            | 5-1  |
| 5.2 | Individual Responses .....                        | 5-13 |
| 6.  | MITIGATION MONITORING AND REPORTING PROGRAM.....  | 6-1  |

## APPENDICES

|            |   |
|------------|---|
| Appendix A | Comment Letters                             |
| Appendix B | West Yost Water Supply Technical Memorandum |

## TABLE OF CONTENTS

### LIST OF FIGURES

|                |   |      |
|----------------|---|------|
| Figure 3-4     | Proposed Urban to Open Space Land Use Changes.....                                  | 3-2  |
| Figure 4.8-2   | <del>Stockton Metropolitan</del> Airport Safety <u>and Compatibility</u> Zones..... | 3-7  |
| Figure 4.9-3.1 | Suitability Index for Groundwater Recharge .....                                    | 3-11 |

### LIST OF TABLES

|             |  |      |
|-------------|--|------|
| Table 2-1   | Summary of Impacts and Mitigation Measures .....                     | 2-7  |
| Table 3-3   | 2040 Development by Study Area .....                                 | 3-3  |
| Table 4.9-2 | Existing and Forecast Water Supplies By Source, EIR Study Area ..... | 3-10 |
| Table 5-1   | Response Matrix .....  | 5-14 |
| Table 6-1   | Mitigation Monitoring and Reporting Program .....                    | 6-2  |

# **1. Introduction**

---

## **1.1 PURPOSE OF THE ENVIRONMENTAL IMPACT REPORT**

This Final Environmental Impact Report (Final EIR), which has been prepared in compliance with the California Environmental Quality Act (CEQA), provides responses to comments received on the Draft Environmental Impact Report (Draft EIR) for the adoption and implementation of the Envision Stockton 2040 General Plan Update and Utility Master Plan Supplements (UMPS) project, herein referred to as “proposed project.” The Draft EIR identifies significant impacts associated with the proposed project, identifies and considers alternatives to the proposed project, and identifies mitigation measures to avoid or reduce potential environmental impacts.

This Final EIR also contains text revisions to the Draft EIR. This document, together with the Draft EIR, will constitute the Final EIR if the Stockton City Council certifies it as complete and adequate under CEQA.

## **1.2 ENVIRONMENTAL REVIEW PROCESS**

According to CEQA, lead agencies are required to consult with public agencies having jurisdiction over a proposed project, and to provide the general public with an opportunity to comment on the Draft EIR. This Final EIR has been prepared to respond to comments received on the Draft EIR and to clarify any errors, omissions, or misinterpretations of discussions of findings in the Draft EIR.

The Draft EIR was made available for public review on June 26, 2018. The Draft EIR was distributed to local and State responsible and trustee agencies, and the general public was advised of the availability of the Draft EIR through public notice published in the local newspaper and posted by the County Clerk, as required by law. The 45-day public comment period ended on August 10, 2018.

On August 2, 2018, a Planning Commission hearing was held to receive comments on the Draft EIR during the official public review period. The hearing was held in the Stockton City Council Chambers, located at 425 North El Dorado Street, 2<sup>nd</sup> Floor in Stockton, California. Copies of all written comments received on the Draft EIR, as well as a summary of the Planning Commission hearing on the Draft EIR, are contained in Appendix A of this document.

The Final EIR will be presented at a Planning Commission hearing, at which the Commission will advise the City Council on certification of the EIR as a full disclosure of potential impacts, mitigation measures, and alternatives. The Planning Commission will not take final action on the EIR or the proposed project. Instead, the City Council will consider the Planning Commission’s recommendations on the Final EIR and

## INTRODUCTION

the proposed General Plan and UMPS during a noticed public hearing, and will take the final action with regard to certification of the Final EIR.

### 1.3 DOCUMENT ORGANIZATION

This document is organized into the following chapters:

- **Chapter 1: Introduction.** This chapter discusses the use and organization of this Final EIR.
- **Chapter 2: Report Summary.** This chapter is a summary of the findings of the Draft and the Final EIR. It has been reprinted from the Draft EIR with necessary changes made in this Final EIR shown in double underline and strikethrough.
- **Chapter 3: Revisions to the Draft EIR.** Corrections to the text and graphics of the Draft EIR are contained in this chapter. Double underlined text represents language that has been added to the EIR; text with strikethrough has been deleted from the EIR.
- **Chapter 4: List of Commenters.** Names of agencies and individuals who commented on the Draft EIR are included in this chapter.
- **Chapter 5: Comments and Responses.** This chapter lists the comments received from agencies and the public on the Draft EIR, and provides responses to those comments.
- **Chapter 6: Mitigation Monitoring and Reporting Program.** This chapter lists the mitigation measures included in the Draft EIR, and identifies programs for monitoring and reporting the progress on implementing these measures.



## 2. Report Summary

---

This is a summary of the findings of the Draft and Final EIRs. This document has been reprinted from the Draft EIR with necessary changes made in this Final EIR shown in double underline and ~~strike through~~.

This chapter presents an overview of the proposed Envision Stockton 2040 General Plan Update and Utility Master Plan Supplements (UMPS), herein referred to as the project or proposed project. This chapter also provides a summary of the alternatives to the proposed project, identifies issues to be resolved, areas of concern, and conclusions of the analysis contained in Chapter 4.0, Environmental Evaluation, of ~~this~~ the Draft Environmental Impact Report (Draft EIR). For a complete description of the proposed project, see Chapter 3, Project Description, of the Draft EIR. For a complete discussion of alternatives to the proposed project, see Chapter 5, Alternatives to the Proposed Project, of the Draft EIR.

~~This~~ The Draft EIR assesses the environmental effects associated with the implementation of the proposed project. The California Environmental Quality Act (CEQA) requires that local government agencies, prior to taking action on projects over which they have discretionary approval authority, consider the environmental consequences of such projects. An EIR is a public document designed to provide the public and local and State governmental agency decision-makers with an analysis of potential environmental consequences to support informed decision-making.

~~This~~ The Draft EIR has been prepared pursuant to the requirements of CEQA<sup>1</sup> and the CEQA Guidelines<sup>2</sup> to determine if approval of the identified discretionary actions and related subsequent development could have a significant effect on the environment (i.e., a significant impact). The City of Stockton, as the lead agency, has reviewed and revised as necessary all submitted drafts, technical studies, and reports to reflect its own independent judgment, including reliance on applicable City technical personnel and review of all technical consultant reports. Information for ~~this~~ the Draft EIR was obtained from on-site field observations; discussions with affected agencies; analysis of adopted plans and policies; review of available studies, reports, data, and similar literature in the public domain; and specialized environmental assessments (e.g., air quality, hazards and hazardous materials, hydrology and water quality, noise, and transportation and circulation).

### 2.1 ENVIRONMENTAL PROCEDURES

~~This~~ The Draft EIR ~~has been~~ was prepared to assess the environmental effects associated with adoption and implementation of the proposed project, as well as anticipated future discretionary actions and approvals.

---

<sup>1</sup> The CEQA Statute is found at California Public Resources Code, Division 13, Sections 21000 to 21177.

<sup>2</sup> The CEQA Guidelines are found at California Code of Regulations, Title 14, Division 6, Chapter 3, Sections 15000 to 15387.

## REPORT SUMMARY

The main purposes of ~~this~~ the Draft EIR document as established by CEQA ~~are~~ is:

- To disclose to decision-makers and the public the significant environmental effects of proposed activities;
- To identify ways to avoid or reduce environmental damage;
- To prevent environmental damage by requiring implementation of feasible alternatives or mitigation measures;
- To disclose to the public reasons for agency approval of projects with significant environmental effects;
- To foster interagency coordination in the review of projects; and
- To enhance public participation in the planning process.

An EIR is the most comprehensive form of environmental documentation identified in the statute and in the CEQA Guidelines. It provides the information needed to assess the environmental consequences of a proposed project, to the extent feasible. An EIR is intended to provide an objective, factually supported, full-disclosure analysis of the environmental consequences associated with a proposed project that has the potential to result in significant, adverse environmental impacts. An EIR is also one of various decision-making tools used by a lead agency to consider the merits and disadvantages of a project that is subject to its discretionary authority. Prior to approving a proposed project, the lead agency must consider the information contained in the EIR, determine whether the EIR was properly prepared in accordance with CEQA and the CEQA Guidelines, determine that it reflects the independent judgment of the lead agency, adopt findings concerning the project's significant environmental impacts and alternatives, and adopt a Statement of Overriding Considerations if the proposed project would result in significant impacts that cannot be avoided or mitigated.

### 2.1.1 REPORT ORGANIZATION

~~This~~ The Draft EIR is organized into the following chapters:

- **Chapter 1: Introduction.** This chapter provides an overview describing the Draft EIR document.
- **Chapter 2: Report Summary.** This chapter summarizes the environmental consequences that would result from implementation of the proposed project, the alternatives to the proposed project, the recommended mitigation measures, and indicates the level of significance of environmental impacts with and without mitigation.
- **Chapter 3: Project Description.** This chapter describes the proposed project in detail, including its characteristics, objectives, and structural and technical elements.
- **Chapter 4: Environmental Evaluation.** This chapter is divided into 15 subchapters. Each subchapter corresponds to the environmental resource categories identified in CEQA Guidelines Appendix F, Energy Conservation, and Appendix G, Environmental Checklist. This chapter provides a description of the physical environmental conditions in the EIR Study Area as they existed at the time the Notice of Preparation was published, as well as an analysis of the potential environmental impacts of the proposed project and recommended mitigation measures, if required, to reduce their significance.

## REPORT SUMMARY

The environmental setting included in each subchapter provides baseline physical conditions from which the City of Stockton, acting as the lead agency, determines the significance of environmental impacts resulting from the proposed project. Each subchapter also includes a description of the thresholds used to determine if a significant impact would occur and the methodology to identify and evaluate the potential impacts of the proposed project, as appropriate.

- **Chapter 5: Alternatives to the Proposed Project.** This chapter includes an evaluation of three alternatives to the proposed project, which are the CEQA-required “No Project” Alternative, the Corridors Focus Alternative, and the Infill Focus Alternative.
- **Chapter 6: CEQA-Required Assessment Conclusions.** This chapter includes a discussion of growth inducement, significant unavoidable effects, and significant irreversible changes as a result of adoption and implementation of the proposed project.
- **Chapter 7: Report Preparation.** This chapter identifies the preparers of the Draft EIR.

### 2.1.2 TYPE AND PURPOSE

According to Section 15121(a) of the CEQA Guidelines, the purpose of an EIR is to:

*Inform public agency decision makers and the public generally of the significant environmental effects of a project, identify possible ways to minimize the significant effects, and describe reasonable alternatives to the project.*

Because of the long-term planning horizon of the proposed project and the permitting, planning, and development actions that are related both geographically and as logical parts in the chain of contemplated actions for implementation, this Draft EIR has been prepared as a program EIR for the proposed project, pursuant to Section 15168 of the CEQA Guidelines.

Once a program EIR has been certified, subsequent activities within the program must be evaluated to determine whether additional CEQA review needs to be prepared. However, if the program EIR addresses the program’s effects as specifically and comprehensively as possible, subsequent activities could be found to be within the program EIR scope, and additional environmental review may not be required (CEQA Guidelines Section 15168[c]). When a program EIR is relied on for a subsequent activity, the lead agency must incorporate feasible mitigation measures and alternatives developed in the program EIR into the subsequent activities (CEQA Guidelines Section 15168[c][3]). If a subsequent activity would have effects that are not within the scope of a program EIR, the lead agency must prepare a new Initial Study leading to a Negative Declaration, a Mitigated Negative Declaration, or an EIR. For these subsequent environmental review documents, this program EIR will serve as the first-tier environmental analysis.

## 2.2 SUMMARY OF THE PROPOSED PROJECT

Upon adoption by the City of Stockton City Council, the Envision Stockton 2040 General Plan Update (proposed General Plan) would serve as the principal policy document to guide future conservation and development in the City of Stockton. The proposed General Plan includes goals, policies, and actions that

## REPORT SUMMARY

have been designed to implement the City's and community's vision for Stockton. The policies and actions are intended to be used by the City to guide day-to-day decision-making so there would be continuing progress toward attainment of the proposed goals. The proposed General Plan is further detailed in Chapter 3, Project Description, of ~~this~~ the Draft EIR.

The proposed Stockton Utility Master Plan Supplements (proposed UMPS) identify needed infrastructure improvements to serve future development. Specifically, the proposed UMPS evaluate and identify needed infrastructure to provide water, wastewater, and stormwater service. These facilities are sized for the amount of development anticipated under the General Plan in its 2040 horizon year, including from approved and pending development projects. The proposed UMPS also present approximate cost information for new infrastructure improvements.

## 2.3 SUMMARY OF PROJECT ALTERNATIVES

~~This~~ The Draft EIR analyzes alternatives to the proposed project that are designed to reduce the significant environmental impacts of the proposed project and feasibly attain some of the proposed project objectives. There is no set methodology for comparing the alternatives or determining the environmentally superior alternative under CEQA. Identification of the environmentally superior alternative involves weighing and balancing all of the environmental resource areas by the City. The following alternatives to the proposed project were considered and analyzed in detail:

- No Project Alternative (existing 2035 General Plan)
- Corridors Focus Alternative
- Infill Focus Alternative

Chapter 5, Alternatives to the Proposed Project, of ~~this~~ the Draft EIR, includes a complete discussion of these alternatives.

## 2.4 ISSUES TO BE RESOLVED

Section 15123(b)(3) of the CEQA Guidelines requires that an EIR identify issues to be resolved, including the choice among alternatives and whether or how to mitigate significant impacts. With regard to the proposed project, the major issues to be resolved include decisions by the City of Stockton, as lead agency, related to:

- Whether ~~this~~ the Draft EIR adequately describes the environmental impacts of the proposed project;
- Whether the benefits of the proposed project override those environmental impacts that cannot be feasibly avoided or mitigated to a level of insignificance;
- Whether the proposed land use changes are compatible with the character of the existing area;
- Whether the identified mitigation measures should be adopted or modified;
- Whether there are other mitigation measures that should be applied to the proposed project besides those mitigation measures identified in the Draft EIR; and

## REPORT SUMMARY

- Whether there are any alternatives to the proposed project that would substantially lessen any of the significant impacts of the proposed project and achieve most of the basic objectives.

## 2.5 AREAS OF CONCERN

The City of Stockton issued a Notice of Preparation (NOP) for the EIR on May 24, 2017 (State Clearinghouse #2017052062) and held a scoping meeting on June 8, 2017 to receive scoping comments. On August 23, 2017, the NOP was subsequently reissued to revise a figure in the project description that shows the extent of proposed urban to agriculture/open space changes, which began a second 30-day review period. During the 30-day scoping periods for ~~this~~ the Draft EIR, responsible agencies and interested members of the public were invited to submit comments as to the scope and content of the EIR. The NOP and Recirculated NOP, as well as the comments received on each NOP and at the scoping meeting, are contained in Appendix A of ~~this~~ the Draft EIR. The comments received focused primarily on the following issues:

- **Air Quality:** Operation, construction and health impacts due to an increase in toxic air contaminants
- **Cultural and Tribal Cultural Resources:** Tribal cultural consultation
- **Hazards and Hazardous Materials:** Compliance with standards included in the 2016 Stockton Metropolitan Airport Land Use Compatibility Plan and the 2009 San Joaquin County Airport Land Use Compatibility Plan
- **Hydrology and Water Quality:** Potential flood hazards, water quality standards, waste discharge requirements, increased runoff, and stormwater discharge
- **Land Use:** Consistency with the Delta Plan
- **Public Services:** Impacts to public service providers
- **Utilities and Service Systems:** Impacts to existing utility infrastructure and facilities, and wastewater treatment
- **Transportation and Circulation:** Cumulative transportation impacts

## 2.6 SIGNIFICANT IMPACTS AND MITIGATION MEASURES

Under CEQA, a significant impact on the environment is defined as a substantial, or potentially substantial, adverse change in any of the physical conditions within the area affected by the proposed project, including land, air, water, minerals, flora, fauna, ambient noise, and objects of historic and aesthetic significance.

The proposed project has the potential to generate significant environmental impacts in a number of areas. As shown in Table 2-1, some significant impacts would be reduced to a less-than-significant level if the mitigation measures identified in ~~this~~ the Draft EIR are adopted and implemented. Pursuant to Section 15126.2(b) of the CEQA Guidelines, an EIR shall describe any significant impacts that cannot be avoided, even with the implementation of feasible mitigation measures. As shown in Table 2-1, significant

## REPORT SUMMARY

unavoidable impacts were identified in the areas of agricultural and forestry resources, air quality, greenhouse gas emissions, noise, population and housing, and transportation and traffic. For a complete summary of the significant and unavoidable impacts, please see Chapter 6, CEQA-Required Assessment Conclusions, of the Draft EIR.

Table 2-1 summarizes the conclusions of the environmental analysis contained in ~~this~~ the Draft EIR and presents a summary of impacts and mitigation measures identified. It is organized to correspond with the environmental issues discussed in Sections 4.1 through 4.15 of the Draft EIR. Table 2-1 is arranged in four columns: 1) environmental impact; 2) significance without mitigation; 3) mitigation measures; and 4) significance with mitigation. For a complete description of potential impacts, please refer to the specific discussions in Sections 4.1 through 4.15.

**REPORT SUMMARY**

**TABLE 2-1 SUMMARY OF IMPACTS AND MITIGATION MEASURES**

| Environmental Impact   | Significance Before Mitigation | Mitigation Measures   | Significance After Mitigation |
|--|--------------------------------|---|-------------------------------|
| <b>AESTHETICS</b>  |                                |   |                               |
| AES-1: Implementation of the proposed project would not have a substantial adverse effect on a scenic vista.   | LTS                            | N/A   | N/A                           |
| AES-2: Implementation of the proposed project would not substantially damage scenic resources, including but not limited to, trees, rock outcroppings, and historic buildings within a State scenic highway.                                     | LTS                            | N/A   | N/A                           |
| AES-3: Implementation of the proposed project would not substantially degrade the existing visual character or quality of the site and its surroundings.   | LTS                            | N/A   | N/A                           |
| AES-4: Implementation of the proposed project would not create a new source of substantial light or glare which would adversely affect day or nighttime views in the area.   | LTS                            | N/A   | N/A                           |
| <b>AGRICULTURAL AND FORESTRY RESOURCES</b>   |                                |   |                               |
| AG-1: Although the proposed General Plan includes policies and actions that would reduce and partially offset the conversion of farmland, it designates approximately 16,160 acres of farmlands of concern under CEQA for non-agricultural uses. | SU                             | N/A   | SU                            |
| AG-2: The proposed General Plan designates 2,464 acres of lands with active Williamson Act contracts for non-agricultural uses.  | <del>SU</del>                  | <del>N/A</del><br><u>N/A-AG-1: Prior to project approval, if a development project will convert prime farmland, farmland of statewide importance, or unique farmland to a non-agricultural use, the project applicant shall demonstrate participation in the City's agricultural conservation program, which requires either dedication of an agricultural conservation easement at a 1:1 ratio or payment of an in-lieu agricultural mitigation fee.</u> | SU                            |
| AG-3: Implementation of the proposed project would not conflict with existing zoning for, or cause rezoning of, forest land, timberland, or timberland zoned Timberland Production.  | No Impact                      | N/A   | N/A                           |
| AG-4: Implementation of the proposed project would not result in the loss of forest land or conversion of forest land to non-forest use.   | LTS                            | N/A   | N/A                           |

## EXECUTIVE SUMMARY

TABLE 2-1 SUMMARY OF IMPACTS AND MITIGATION MEASURES

| Environmental Impact   | Significance Before Mitigation | Mitigation Measures   | Significance After Mitigation |
|--|--------------------------------|---|-------------------------------|
| AG-5: Implementation of the proposed project would not involve other changes in the existing environment which, due to their location or nature, could result in conversion of farmlands of concern under CEQA to non-agricultural use or conversion of forest land to non-forest use. | LTS                            | N/A   | N/A                           |
| <b>AIR QUALITY</b>   |                                |   |                               |
| AQ-1: Implementation of the proposed General Plan would result in the generation of substantial long-term criteria air pollutant emissions that would exceed the SJVAPCD regional significance thresholds and would therefore not be considered consistent with the existing AQMPs.    | S                              | AQ-1: Implement Mitigation Measure AQ-3 to further reduce long-term criteria air pollutant emissions.   | SU                            |
| AQ-2: Construction activities associated with implementation of the proposed General Plan and UMPS could exceed the SJVAPCD regional significance thresholds.  | S                              | <p>AQ-2: Prior to issuance of any construction permits for development projects subject to California Environmental Quality Act (CEQA) review (i.e., non-exempt projects), development project applicants shall prepare and submit to the City of Stockton Planning and Engineering Division a technical assessment evaluating potential project construction-related air quality impacts. The evaluation shall be prepared in conformance with San Joaquin Valley Air Pollution Control District (SJVAPCD) methodology in assessing air quality impacts. The prepared evaluation for projects that meet the SJVAPCD Small Projects Analysis Level (SPAL) screening criteria shall at minimum, identify the primary sources of construction emissions and include a discussion of the applicable SJVAPCD rules and regulations and SPAL screening criteria to support a less than significant conclusion.</p> <p>For projects that do not meet the SPAL screening criteria, project-related construction emissions shall be quantified. If construction-related criteria air pollutants are determined to have the potential to exceed the SJVAPCD adopted thresholds of significance, as identified in the Guidance for Assessing and Mitigating Air Quality Impacts (GAMAQI), the City of Stockton Planning and Engineering Division shall require that applicants for new development projects</p> | SU                            |



**REPORT SUMMARY**

**TABLE 2-1      SUMMARY OF IMPACTS AND MITIGATION MEASURES**

| Environmental Impact | Significance Before Mitigation | Mitigation Measures   | Significance After Mitigation |
|----------------------|--------------------------------|---|-------------------------------|
|                      |                                | <p>incorporate mitigation measures to reduce air pollutant emissions during construction activities to below these thresholds. These identified measures shall be incorporated into appropriate construction documents (e.g., construction management plans) submitted to the City and shall be verified by the City’s Planning and Engineering Division. Mitigation measures to reduce construction-related emissions could include, but are not limited to:</p> <ul style="list-style-type: none"> <li>▪ Using construction equipment rated by the United States Environmental Protection Agency as having Tier 3 (model year 2006 or newer) or Tier 4 (model year 2008 or newer) emission limits, applicable for engines between 50 and 750 horsepower. A list of construction equipment by type and model year shall be maintained by the construction contractor on-site, which shall be available for City review upon request.</li> <li>▪ Ensuring construction equipment is properly serviced and maintained to the manufacturer’s standards.</li> <li>▪ Use of alternative-fueled or catalyst-equipped diesel construction equipment, if available and feasible.</li> <li>▪ Clearly posted signs that require operators of trucks and construction equipment to minimize idling time (e.g., five-minute maximum).</li> <li>▪ Preparation and implementation of a fugitive dust control plan that may include the following measures:                             <ul style="list-style-type: none"> <li>• Disturbed areas (including storage piles) that are not being actively utilized for construction purposes shall be effectively stabilized using water, chemical stabilizer/suppressant, or covered with a tarp or other suitable cover (e.g., revegetated).</li> <li>• On-site unpaved roads and offsite unpaved access roads shall be effectively stabilized using water or chemical stabilizer/suppressant.</li> <li>• Land clearing, grubbing, scraping, excavation, land leveling, grading, cut and fill, and demolition activities shall be effectively controlled utilizing application of water or by presoaking.</li> </ul> </li> </ul> |                               |

## EXECUTIVE SUMMARY

TABLE 2-1 SUMMARY OF IMPACTS AND MITIGATION MEASURES

| Environmental Impact | Significance Before Mitigation | Mitigation Measures  | Significance After Mitigation |
|----------------------|--------------------------------|--|-------------------------------|
|                      |                                | <ul style="list-style-type: none"> <li>• Material shall be covered, or effectively wetted to limit visible dust emissions, and at least six inches of freeboard space from the top of the container shall be maintained when materials are transported offsite.</li> <li>• Operations shall limit or expeditiously remove the accumulation of mud or dirt from adjacent public streets at the end of each workday. (The use of dry rotary brushes is expressly prohibited except where preceded or accompanied by sufficient wetting to limit the visible dust emissions.) (Use of blower devices is expressly forbidden.) <u>(Utilize electric-powered vacuums or devices to capture materials.)</u></li> <li>• Following the addition of materials to or the removal of materials from the surface of outdoor storage piles, said piles shall be effectively stabilized of fugitive dust emissions utilizing sufficient water or chemical stabilizer/suppressant.</li> <li>• Within urban areas, trackout shall be immediately removed when it extends 50 or more feet from the site and at the end of each workday.</li> <li>• Any site with 150 or more vehicle trips per day shall prevent carryout and trackout.</li> <li>• Limit traffic speeds on unpaved roads to 15 mph.</li> <li>• Install sandbags or other erosion control measures to prevent silt runoff to public roadways from sites with a slope greater than 1 percent.</li> <li>• Install wheel washers for all exiting trucks or wash off all trucks and equipment leaving the project area.</li> <li>• Adhere to Regulation VIII’s 20 percent opacity limitation, as applicable.</li> <li>▪ Enter into a Voluntary Emissions Reduction Agreement (VERA) with the SJVAPCD. The VERA shall identify the amount of emissions to be reduced, in addition to the amount of funds to be paid by the project applicant to the SJVAPCD to implement emission reduction projects required for the project.</li> </ul> |                               |

**REPORT SUMMARY**

**TABLE 2-1      SUMMARY OF IMPACTS AND MITIGATION MEASURES**

| Environmental Impact  | Significance Before Mitigation | Mitigation Measures  | Significance After Mitigation |
|---|--------------------------------|--|-------------------------------|
| AQ-3: Operation of development projects allowed under the proposed General Plan would generate emissions that would exceed the SJVAPCD regional significance thresholds for VOC, NO <sub>x</sub> , CO, PM <sub>10</sub> , and PM <sub>2.5</sub> . | S                              | <p>AQ-3: Prior to discretionary approval by the City of Stockton for development projects subject to California Environmental Quality Act (CEQA) review (i.e., non-exempt projects), project applicants shall prepare and submit a technical assessment evaluating potential project operation phase-related air quality impacts to the City of Stockton Planning and Engineering Division for review and approval. The evaluation shall be prepared in conformance with San Joaquin Air Pollution Control District (SJVAPCD) methodology in assessing air quality impacts. If operation-related air pollutants are determined to have the potential to exceed the SJVAPCD-adopted thresholds of significance, as identified in the Guidance for Assessing and Mitigating Air Quality Impacts (GAMAQI), the City of Stockton Planning and Engineering Division shall require that applicants for new development projects incorporate mitigation measures to reduce air pollutant emissions during operational activities. The identified measures shall be included as part of the conditions of approval. Possible mitigation measures to reduce long-term emissions can include, but are not limited to the following:</p> <ul style="list-style-type: none"> <li>▪ For site-specific development that requires refrigerated vehicles, the construction documents shall demonstrate an adequate number of electrical service connections at loading docks for plug-in of the anticipated number of refrigerated trailers to reduce idling time and emissions.</li> <li>▪ Applicants for manufacturing and light industrial uses shall consider energy storage and combined heat and power in appropriate applications to optimize renewable energy generation systems and avoid peak energy use.</li> <li>▪ Site-specific developments with truck delivery and loading areas and truck parking spaces shall include signage as a reminder to limit idling of vehicles while parked for loading/unloading in accordance with Section 2485 of 13 CCR Chapter 10.</li> <li>▪ Provide changing/shower facilities as specified, at minimum, or greater than in the guidelines in Section A5.106.4.3 of the CALGreen Code (Nonresidential Voluntary Measures).</li> </ul> | SU                            |

**EXECUTIVE SUMMARY**

**TABLE 2-1 SUMMARY OF IMPACTS AND MITIGATION MEASURES**

| Environmental Impact   | Significance Before Mitigation | Mitigation Measures  | Significance After Mitigation |
|--|--------------------------------|--|-------------------------------|
| AQ-4: Development allowed under the proposed General Plan and UMPS could result in short- and long-term emissions that could cause or contribute to a violation of the AAQS. | S                              | <ul style="list-style-type: none"> <li>▪ Provide bicycle parking facilities equivalent to or greater than as specified in Section A4.106.9 (Residential Voluntary Measures) of the CALGreen Code.</li> <li>▪ Provide preferential parking spaces for low-emitting, fuel-efficient, and carpool/van vehicles equivalent to or greater than Section A5.106.5.1 of the CALGreen Code (Nonresidential Voluntary Measures).</li> <li>▪ Provide facilities to support electric charging stations per Section A5.106.5.3 (Nonresidential Voluntary Measures) and Section A5.106.8.2 (Residential Voluntary Measures) of the CALGreen Code.</li> <li>▪ Applicant-provided appliances shall be Energy Star-certified appliances or appliances of equivalent energy efficiency (e.g., dishwashers, refrigerators, clothes washers, and dryers). Installation of Energy Star-certified or equivalent appliances shall be verified by Building &amp; Safety during plan check.</li> <li>▪ Applicants for future development projects along existing and planned transit routes shall coordinate with the City Stockton and San Joaquin Regional Transit District to ensure that bus pad and shelter improvements are incorporated, as appropriate, <u>and that these transit improvements consider and implement design features (e.g., pullout lanes for buses) to avoid or reduce impediment/queuing of vehicles.</u></li> <li>▪ Applicants for future development projects shall enter into a Voluntary Emissions Reduction Agreement (VERA) with the San Joaquin Valley Air Pollution Control District (SJVAPCD). The VERA shall identify the amount of emissions to be reduced, in addition to the amount of funds to be paid by the project applicant to the SJVAPCD to implement emission reduction projects required for the project.</li> </ul> | SU                            |

**REPORT SUMMARY**

**TABLE 2-1      SUMMARY OF IMPACTS AND MITIGATION MEASURES**

| Environmental Impact | Significance Before Mitigation | Mitigation Measures  | Significance After Mitigation |
|----------------------|--------------------------------|--|-------------------------------|
|                      |                                | <p>AQ-4b: Prior to discretionary approval, applicants for development projects that are subject to the California Environmental Quality Act (CEQA) shall assess their projects to the San Joaquin Valley Air Pollution Control District’s (SJVAPCD) Rule 9510 Applicability Thresholds as follows:</p> <ul style="list-style-type: none"> <li>▪ 50 residential units;</li> <li>▪ 2,000 square feet of commercial space;</li> <li>▪ 25,000 square feet of light industrial space;</li> <li>▪ 100,000 square feet of heavy industrial space;</li> <li>▪ 20,000 square feet of medical office space;</li> <li>▪ 39,000 square feet of general office space;</li> <li>▪ 9,000 square feet of education space;</li> <li>▪ 10,000 square feet of government space;</li> <li>▪ 20,000 square feet of recreational space; or</li> <li>▪ 9,000 square feet of space not identified above.</li> </ul> <p>Applicants for development projects subject to CEQA that do not meet the SJVAPCD Rule 9510 Applicability Thresholds shall assess whether project-related construction and operational emissions exceed the SJVAPCD 100 pounds per day ambient air quality screening threshold. Applicants for development projects that exceed this ambient air quality screening threshold shall prepare or have prepared an ambient air quality analysis, consistent with the SJVAPCD Guidance for Assessing and Mitigating Air Quality Impacts (GAMAQI), to assess whether the subject development project would cause or contribute to a violation of any California Ambient Air Quality Standard or National Ambient Air Quality Standard. The ambient air quality analysis shall identify measures to reduce impacts as necessary. Recommended measures may include those identified in Mitigation Measures AQ-2 and AQ-3. The related recommendations of the ambient air quality analysis shall be incorporated into all construction management and design plans and which shall be submitted to the City and verified by the City’s Planning and Engineering Division.</p> |                               |

**EXECUTIVE SUMMARY**

**TABLE 2-1 SUMMARY OF IMPACTS AND MITIGATION MEASURES**

| Environmental Impact  | Significance Before Mitigation | Mitigation Measures  | Significance After Mitigation |
|---|--------------------------------|--|-------------------------------|
| <p>AQ-5: Implementation of the proposed General Plan could expose sensitive receptors to substantial toxic air contaminant concentrations from non-permitted sources.</p> | S                              | <p>AQ-5: Prior to discretionary project approval, applicants for industrial or warehousing land uses in addition to commercial land uses that would generate substantial diesel truck travel (i.e., 100 diesel trucks per day or 40 or more trucks with diesel-powered transport refrigeration units per day based on the California Air Resources Board recommendations for siting new sensitive land uses), shall contact the San Joaquin Valley Air Pollution Control District (SJVAPCD) or the City of Stockton in conjunction with the SJVAPCD to determine the appropriate level of health risk assessment (HRA) required. If preparation of an HRA is required, all HRAs shall be submitted to the City of Stockton and the SJVAPCD for evaluation.</p> <p>The HRA shall be prepared in accordance with policies and procedures of the State Office of Environmental Health Hazard Assessment and the SJVAPCD. If the HRA shows that the incremental cancer risk exceeds ten in one million (10E-06) or the risk thresholds in effect at the time a project is considered, or that the appropriate noncancer hazard index exceeds 1.0 or the thresholds as determined by the SJVAPCD at the time a project is considered, the applicant will be required to identify and demonstrate that measures are capable of reducing potential cancer and noncancer risks to an acceptable level, including appropriate enforcement mechanisms.</p> <p>Measures to reduce risk impacts may include but are not limited to:</p> <ul style="list-style-type: none"> <li>▪ Restricting idling on-site beyond Air Toxic Control Measures idling restrictions, as feasible.</li> <li>▪ Electrifying warehousing docks.</li> <li>▪ Requiring use of newer equipment and/or vehicles.</li> <li>▪ Restricting offsite truck travel through the creation of truck routes.</li> </ul> <p>Measures identified in the HRA shall be identified as mitigation measures in the environmental document and/or incorporated into the site development plan as a component of the proposed project.</p> | LTS                           |

**REPORT SUMMARY**

**TABLE 2-1      SUMMARY OF IMPACTS AND MITIGATION MEASURES**

| Environmental Impact   | Significance Before Mitigation | Mitigation Measures  | Significance After Mitigation |
|--|--------------------------------|--|-------------------------------|
| AQ-6: Operation of new industrial land uses accommodated under the proposed General Plan has the potential to create objectionable odors that could affect a substantial number of people. | S                              | <p>AQ-6: Prior to project approval, if it is determined during project-level environmental review that a project has the potential to emit nuisance odors beyond the property line, an odor management plan shall be prepared and submitted by the project applicant prior to project approval to ensure compliance with San Joaquin Valley Air Pollution Control District (SJVAPCD) Rule 4102. The following facilities that are within the buffer distances specified from sensitive receptors (in parentheses) have the potential to generate substantial odors:</p> <ul style="list-style-type: none"> <li>▪ Wastewater Treatment Plan (2 miles)</li> <li>▪ Sanitary Landfill (1 mile)</li> <li>▪ Transfer Station (1 mile)</li> <li>▪ Composting Facility (1 mile)</li> <li>▪ Petroleum Refinery (2 miles)</li> <li>▪ Asphalt Batch Plan (1 mile)</li> <li>▪ Chemical Manufacturing (1 mile)</li> <li>▪ Fiberglass Manufacturing (1 mile)</li> <li>▪ Painting/Coating Operations (1 mile)</li> <li>▪ Food Processing Facility (1 mile)</li> <li>▪ Feed Lot/ Dairy (1 mile)</li> <li>▪ Rendering Plant (1 mile)</li> </ul> <p>The Odor Management Plan prepared for these facilities shall identify control technologies that will be utilized to reduce potential odors to acceptable levels, including appropriate enforcement mechanisms. Control technologies may include but are not limited to scrubbers (e.g., air pollution control devices) at an industrial facility. Control technologies identified in the odor management plan shall be identified as mitigation measures in the environmental document and/or incorporated into the site plan.</p> | LTS                           |

## EXECUTIVE SUMMARY

**TABLE 2-1 SUMMARY OF IMPACTS AND MITIGATION MEASURES**

| Environmental Impact   | Significance Before Mitigation | Mitigation Measures | Significance After Mitigation |
|--|--------------------------------|---------------------|-------------------------------|
| <b>BIOLOGICAL RESOURCES</b>  |                                |                     |                               |
| BIO-1: Implementation of the proposed project would not have a substantial adverse effect on any species identified as a candidate, sensitive, or special status species.  | LTS                            | N/A                 | N/A                           |
| BIO-2: Implementation of the proposed project would not have a substantial adverse effect on any riparian habitat or other sensitive natural community.  | LTS                            | N/A                 | N/A                           |
| BIO-3: Implementation of the proposed project would not have a substantial adverse effect on federally protected wetlands.   | LTS                            | N/A                 | N/A                           |
| BIO-4: Implementation of the proposed project would not interfere substantially with the movement of any native resident or migratory fish and wildlife species or with established native resident or migratory wildlife corridors, or impede the use of native wildlife nursery sites. | LTS                            | N/A                 | N/A                           |
| BIO-5: Implementation of the proposed project would not conflict with any local policies or ordinances protecting biological resources.  | LTS                            | N/A                 | N/A                           |
| BIO-6: Implementation of the proposed project would not conflict with the provisions of an adopted Habitat Conservation Plan, Natural Community Conservation Plan, or other approved local, regional, or State habitat conservation plan.  | LTS                            | N/A                 | N/A                           |
| <b>CULTURAL AND TRIBAL CULTURAL RESOURCES</b>  |                                |                     |                               |
| CULT-1: Implementation of the proposed project would not cause a substantial adverse change in the significance of an historical resource.   | LTS                            | N/A                 | N/A                           |
| CULT-2: Implementation of the proposed project would not cause a substantial adverse change in the significance of an archaeological resource.   | LTS                            | N/A                 | N/A                           |
| CULT-3: Implementation of the proposed project would not directly or indirectly destroy a unique paleontological resource or site or unique geologic feature.  | LTS                            | N/A                 | N/A                           |



**REPORT SUMMARY**

**TABLE 2-1 SUMMARY OF IMPACTS AND MITIGATION MEASURES**

| Environmental Impact   | Significance Before Mitigation | Mitigation Measures | Significance After Mitigation |
|--|--------------------------------|---------------------|-------------------------------|
| CULT-4: Implementation of the proposed project would not disturb any human remains.  | LTS                            | N/A                 | N/A                           |
| CULT-5: Implementation of the proposed project would not cause a substantial adverse change in the significance of a tribal cultural resource.   | LTS                            | N/A                 | N/A                           |
| <b>GEOLOGY, SOILS, SEISMICITY, AND MINERAL RESOURCES</b>   |                                |                     |                               |
| GEO-1: Implementation of the proposed project would not expose people or structures to potential substantial adverse effects involving rupture of a known earthquake fault; strong seismic ground shaking; seismic-related ground failure, including liquefaction; or landslides.  | LTS                            | N/A                 | N/A                           |
| GEO-2: Implementation of the proposed project would not result in substantial soil erosion or the loss of topsoil.   | LTS                            | N/A                 | N/A                           |
| GEO-3: Implementation of the proposed project would not result in a significant impact related to development on unstable geologic units or soils or result in lateral spreading, subsidence, liquefaction, or collapse.   | LTS                            | N/A                 | N/A                           |
| GEO-4: Implementation of the proposed project would not create substantial risks to property as a result of its location on expansive soil, as defined by Section 1803.5.3 of the California Building Code.  | LTS                            | N/A                 | N/A                           |
| GEO-5: Implementation of the proposed project would not have soils incapable of adequately supporting the use of septic tanks or alternative wastewater disposal systems where sewers are not available for the disposal of wastewater.  | LTS                            | N/A                 | N/A                           |
| GEO-6: Implementation of the proposed project would a) result in the loss of availability of a known mineral resource that would be of value to the region and the residents of the state, or b) result in the loss of availability of a locally-important mineral resource recovery site delineated on a local general plan, specific plan, or other land use plan. | LTS                            | N/A                 | N/A                           |

**EXECUTIVE SUMMARY**

**TABLE 2-1 SUMMARY OF IMPACTS AND MITIGATION MEASURES**

| Environmental Impact  | Significance Before Mitigation | Mitigation Measures  | Significance After Mitigation |
|---|--------------------------------|--|-------------------------------|
| <b>GREENHOUSE GAS EMISSIONS</b>   |                                |  |                               |
| GHG-1: Implementation of the proposed General Plan would result in a substantial increase in GHG emissions. | S                              | <p>GHG-1: Within 24 months of adoption of the proposed General Plan, the City of Stockton shall proceed to adoption hearings for an update to its Climate Action Plan (CAP). The CAP shall provide:</p> <ul style="list-style-type: none"> <li>▪ GHG inventories of existing and 2030 GHG levels;</li> <li>▪ Targets for 2030 from land uses under the City’s jurisdiction based on the goals of SB 32; and</li> <li>▪ Tools and strategies for reducing GHG emissions in accordance with the 2030 goals of the CAP.</li> </ul> <p>The City shall consider the following GHG reduction measures in its CAP Update:</p> <ul style="list-style-type: none"> <li>▪ Reevaluate the City’s current green building requirements (Stockton Municipal Code Chapter 15.72, Green Building Standards) every five years to consider additional requirements for substantial new residential and non-residential development to ensure that new development achieves a performance objective consistent with the best performing (top 25 percent) of city green building measures in the state.</li> <li>▪ Require financing and/or installing energy-saving retrofits on existing structures as potential mitigation measures for discretionary projects that have significant GHG impacts as part of the CEQA process.</li> <li>▪ Utilize transfer of development rights and other mechanisms, such as an infill mitigation bank, to enhance the viability of development in the Greater Downtown.</li> <li>▪ Establish a goal for 15 percent of existing development to install solar panels over carports.</li> <li>▪ Establish a goal to achieve 10 percent of non-residential electricity and 5 percent of residential electricity entirely by solar.</li> <li>▪ Offer incentives for contractors that use electric equipment when bidding on City contracts.</li> <li>▪ Limit non-essential idling of large construction equipment to no</li> </ul> | SU                            |

**REPORT SUMMARY**

**TABLE 2-1 SUMMARY OF IMPACTS AND MITIGATION MEASURES**

| Environmental Impact   | Significance Before Mitigation | Mitigation Measures   | Significance After Mitigation |
|--|--------------------------------|---|-------------------------------|
|  |                                | <p>more than 3 minutes.</p> <p>In addition, to implement the CAP, the City shall develop key ordinances, programs, and policies required to promote voluntary, incentive-based measures in the CAP, establish the planning framework for the performance-based development review process, and support and implement the local mandatory GHG reduction measures. These implementation tasks include:</p> <ul style="list-style-type: none"> <li>▪ Update the community GHG inventory to monitor emissions trends every five years.</li> <li>▪ In 2030, develop a plan for post-2030 actions.</li> <li>▪ Appoint an Implementation Coordinator to oversee the successful implementation of all selected GHG reduction strategies. The primary function of the Implementation Coordinator will be to create a streamlined approach to manage implementation of the CAP. The Implementation Coordinator will also coordinate periodic community outreach to leverage community involvement, interest, and perspectives.</li> </ul> |                               |
| GHG-2: Implementation of the proposed project would not conflict with an applicable plan, policy, or regulation adopted for the purpose of reducing the emissions of GHGs.   | LTS                            | N/A   | N/A                           |
| <b>HAZARDS AND HAZARDOUS MATERIALS</b>   |                                |   |                               |
| HAZ-1: Implementation of the proposed project would not create a significant hazard to the public or the environment through the routine transport, use, or disposal of hazardous materials.   | LTS                            | N/A   | N/A                           |
| HAZ-2: Implementation of the proposed project would not create a significant hazard to the public or the environment through reasonably foreseeable upset and accident conditions involving the release of hazardous materials into the environment. | LTS                            | N/A   | N/A                           |
| HAZ-3: Implementation of the proposed project would not emit hazardous emissions or handle hazardous or acutely hazardous materials, substances, or waste within ¼-mile of an existing or proposed school.   | LTS                            | N/A   | N/A                           |

## EXECUTIVE SUMMARY

**TABLE 2-1 SUMMARY OF IMPACTS AND MITIGATION MEASURES**

| <b>Environmental Impact</b>   | <b>Significance Before Mitigation</b> | <b>Mitigation Measures</b> | <b>Significance After Mitigation</b> |
|---|---------------------------------------|----------------------------|--------------------------------------|
| HAZ-4: Implementation of the proposed project would not create a significant hazard to the public or the environment as a result of being located on a site which is included on a list of hazardous materials sites compiled pursuant to Government Code Section 65962.5.                | LTS                                   | N/A                        | N/A                                  |
| HAZ-5: Implementation of the proposed project would not result in a safety hazard for people residing or working within the airport land use plan area.   | LTS                                   | N/A                        | N/A                                  |
| HAZ-6: Implementation of the proposed project would not be within the vicinity of a private airstrip and would not result in a safety hazard for people residing or working in the project area.  | No Impact                             | N/A                        | N/A                                  |
| HAZ-7: Implementation of the proposed project would not impair implementation of, or physically interfere with, an adopted emergency response plan or emergency evacuation plan.  | LTS                                   | N/A                        | N/A                                  |
| HAZ-8: Implementation of the proposed project would not expose people or structures to a significant risk of loss, injury, or death involving wildland fires.   | LTS                                   | N/A                        | N/A                                  |
| <b>HYDROLOGY AND WATER QUALITY</b>  |                                       |                            |                                      |
| HYDRO-1: Implementation of the proposed project would not violate any water quality standards or discharge requirements.  | LTS                                   | N/A                        | N/A                                  |
| HYDRO-2.1: Implementation of the proposed project would not substantially deplete groundwater supplies.   | LTS                                   | N/A                        | N/A                                  |
| HYDRO-2.2: Implementation of the proposed project would not substantially interfere with groundwater recharge.  | LTS                                   | N/A                        | N/A                                  |
| HYDRO-3: Implementation of the proposed project would not substantially alter the existing drainage pattern of the site or area, including through the alteration of the course of a stream or river, in a manner which would result in substantial erosion or siltation on- or off-site. | LTS                                   | N/A                        | N/A                                  |
| HYDRO-4: Implementation of the proposed project would not substantially alter the existing drainage pattern of the site or area, including through the alteration of the course of a stream or river,   | LTS                                   | N/A                        | N/A                                  |

**REPORT SUMMARY**

**TABLE 2-1 SUMMARY OF IMPACTS AND MITIGATION MEASURES**

| Environmental Impact  | Significance Before Mitigation | Mitigation Measures   | Significance After Mitigation |
|---|--------------------------------|---|-------------------------------|
| or substantially increase the rate or amount of surface runoff in a manner which would result in flooding on- or off-site.  |                                |   |                               |
| HYDRO-5: Development allowed under the proposed General Plan could result in existing and planned stormwater drain infrastructure to be undersized or otherwise inadequate, which could lead to flooding and polluted runoff. | S                              | HYDRO-5: Complete a citywide storm drainage master plan, including hydrologic and hydraulic models for existing land use conditions and for the land uses anticipated in 2040 under the proposed General Plan. The master plan should identify the future stormwater infrastructure needs and develop a current stormwater capital improvement plan. As part of this process, <u>identify areas that have constraints, prioritize watersheds to be modeled, and evaluate the City stormwater fee program for potential revisions. In addition, require new development to complete stormwater plans covering drainage, flood control, and storm water quality/permitting. Use the master plan and project-level stormwater plans to assess future development, and require that future development construct the required on- and off-site infrastructure. <u>Implementation of this mitigation measure should be timed to anticipate and precede significant developments that would be most likely to place large demands on the current stormwater system.</u></u> | LTS                           |
| HYDRO-6: Implementation of the proposed project would not otherwise substantially degrade water quality.  | LTS                            | N/A   | N/A                           |
| HYDRO-7: Implementation of the proposed project would place housing within a 100-year flood hazard area as mapped on a federal Flood Hazard Boundary or Flood Insurance Rate Map or other flood hazard delineation map.       | LTS                            | N/A   | N/A                           |
| HYDRO-8: Implementation of the proposed project would not place within a 100-year flood hazard area structures which would impede or redirect flood flows.  | LTS                            | N/A   | N/A                           |
| HYDRO-9: Implementation of the proposed project would not expose people or structures to a significant risk of loss, injury, or death involving flooding, including flooding as a result of the failure of a levee or dam.    | LTS                            | N/A   | N/A                           |
| HYDRO-10: Implementation of the proposed project would not cause substantial flood hazards arising from seiche, tsunami, or   | LTS                            | N/A   | N/A                           |

## EXECUTIVE SUMMARY

**TABLE 2-1 SUMMARY OF IMPACTS AND MITIGATION MEASURES**

| Environmental Impact   | Significance Before Mitigation | Mitigation Measures | Significance After Mitigation |
|--|--------------------------------|---------------------|-------------------------------|
| mudflow.   |                                |                     |                               |
| <b>LAND USE AND PLANNING</b>   |                                |                     |                               |
| LU-1: Implementation of the proposed project would not physically divide an established community.   | LTS                            | N/A                 | N/A                           |
| LU-2: Implementation of the proposed project would not conflict with any applicable land use plan, policy, or regulation of an agency with jurisdiction over the project adopted for the purpose of avoiding or mitigating an environmental effect.  | LTS                            | N/A                 | N/A                           |
| LU-3: Implementation of the proposed project would not conflict with any applicable habitat conservation plan or natural community conservation plan.  | LTS                            | N/A                 | N/A                           |
| <b>NOISE</b>   |                                |                     |                               |
| NOISE-1: The proposed project would not expose people to or generate noise levels in excess of standards established in the General Plan or the Municipal Code, and/or the applicable standards of other agencies.   | LTS                            | N/A                 | N/A                           |
| NOISE-2: The proposed project would not expose people to or generate excessive groundborne vibration or groundborne noise levels.  | LTS                            | N/A                 | N/A                           |
| NOISE-3: Increased traffic from projected development allowed by the proposed General Plan would result in a significant increase in traffic noise levels compared to existing conditions along the following roadway segments:  | S                              | N/A                 | SU                            |
| <ol style="list-style-type: none"> <li>1. SR-99 between Farmington Road and Mariposa Road</li> <li>2. SR-4 west of I-5</li> <li>3. Eight Mile Road between Mokelumne Drive and Trinity Parkway</li> <li>4. Eight Mile Road between West Lane and SP Railroad</li> <li>5. Eight Mile Road between SR-99 and west of Bear Creek</li> </ol> |                                |                     |                               |

**REPORT SUMMARY**

**TABLE 2-1 SUMMARY OF IMPACTS AND MITIGATION MEASURES**

| Environmental Impact  | Significance Before Mitigation | Mitigation Measures | Significance After Mitigation |
|---|--------------------------------|---------------------|-------------------------------|
| 6. March Lane between West Land and Bianchi   |                                |                     |                               |
| 7. French Camp Road between McDougald and E.W.S Wood  |                                |                     |                               |
| 8. California Street between Park and Weber   |                                |                     |                               |
| 9. California Street between Weber and Crosstown Freeway  |                                |                     |                               |
| 10. Airport Way between Main and Market   |                                |                     |                               |
| 11. Airport Way between Ninth and Tenth   |                                |                     |                               |
| 12. Airport Way between Sperry and CE Dixon St  |                                |                     |                               |
| 13. Mariposa Road between Stagecoach and SR-99  |                                |                     |                               |
| 14. B Street between Ralph Avenue and Arch Airport  |                                |                     |                               |
| NOISE-4: The proposed project would cause a substantial temporary or periodic increase in ambient noise levels in the project vicinity above levels existing without the project.             | LTS                            | N/A                 | N/A                           |
| NOISE-5: The proposed project would not expose people residing or working in the vicinity of the project area to excessive aircraft noise levels from a public airport or public use airport. | LTS                            | N/A                 | N/A                           |
| NOISE-6: The proposed project would not expose people residing or working in the project area to excessive noise levels from a private airstrip.  | LTS                            | N/A                 | N/A                           |
| <b>POPULATION AND HOUSING</b>   |                                |                     |                               |
| POP-1: The proposed General Plan and UMPS would induce substantial employment growth within the EIR Study Area.   | S                              | N/A                 | SU                            |
| POP-2: Implementation of the proposed project would not displace substantial numbers of existing housing units, necessitating the construction of replacement housing elsewhere.              | LTS                            | N/A                 | N/A                           |
| POP-3: Implementation of the proposed project would not displace substantial numbers of people, necessitating the construction of replacement housing elsewhere.                              | LTS                            | N/A                 | N/A                           |
| <b>PUBLIC SERVICES AND RECREATION</b>   |                                |                     |                               |
| PS-1: Implementation of the proposed project would not result in the need for new or physically altered fire protection facilities, the   | LTS                            | N/A                 | N/A                           |

## EXECUTIVE SUMMARY

**TABLE 2-1 SUMMARY OF IMPACTS AND MITIGATION MEASURES**

| Environmental Impact  | Significance Before Mitigation | Mitigation Measures | Significance After Mitigation |
|---|--------------------------------|---------------------|-------------------------------|
| construction of which could cause significant environmental impacts, in order to maintain acceptable service ratios, response times, or other performance objectives.   |                                |                     |                               |
| PS-2: Implementation of the proposed project would not result in the need for new or physically altered police protection facilities, the construction of which could cause significant environmental impacts, in order to maintain acceptable service ratios, response times, or other performance objectives. | LTS                            | N/A                 | N/A                           |
| PS-3: Implementation of the proposed project would not result in the need for new or physically altered park facilities, the construction of which could cause significant environmental impacts, in order to maintain acceptable service ratios, or other performance objectives.                              | LTS                            | N/A                 | N/A                           |
| PS-4: Implementation of the proposed project would not increase the use of existing neighborhood and regional parks or other recreational facilities, such that substantial physical deterioration of the facility would occur, or be accelerated.  | LTS                            | N/A                 | N/A                           |
| PS-5: Implementation of the proposed project would not include recreational facilities and or require the construction or expansion of recreational facilities which might have an adverse physical effect on the environment.  | LTS                            | N/A                 | N/A                           |
| PS-6: Implementation of the proposed project would not result in the need for new or physically altered school facilities, the construction of which could cause significant environmental impacts, in order to maintain acceptable service ratios, or other performance objectives.                            | LTS                            | N/A                 | N/A                           |
| PS-7: Implementation of the proposed project would not result in the need for new or physically altered library facilities, the construction of which could cause significant environmental impacts, in order to maintain acceptable service ratios, or other performance objectives.                           | LTS                            | N/A                 | N/A                           |



**REPORT SUMMARY**

**TABLE 2-1      SUMMARY OF IMPACTS AND MITIGATION MEASURES**

| Environmental Impact   | Significance Before Mitigation | Mitigation Measures   | Significance After Mitigation |
|--|--------------------------------|---|-------------------------------|
| <b>TRANSPORTATION AND TRAFFIC</b>  |                                |   |                               |
| <p>TRAF-1: Implementation of the proposed General Plan, in combination with regional growth, would result in increased vehicle traffic, which would affect the operation of local roadways and freeway segments. As shown in Table 4-14.2 and discussed above, the proposed General Plan would result in significant level of service impacts to roadway and freeway segments.</p> | S                              | <p>TRAF-1a: The City shall implement the following to reduce the severity of potential LOS impacts on the following City roadway segments:</p> <ul style="list-style-type: none"> <li>▪ <b>March Lane at UPRR.</b> The adopted 2035 General Plan identifies an eight-lane cross section for this roadway from North El Dorado Street to State Route 99. The proposed General Plan envisions a six-lane cross-section through 2040. With an eight-lane cross-section, the roadway would operate within the established LOS policy. Therefore, to mitigate the impact, the City shall reserve sufficient right-of-way to accommodate an eight-lane cross-section, plus associated turn pockets at intersections. Construction of an eight-lane cross-section would result in an acceptable level of service for vehicles, but could preclude the provision of facilities that would encourage higher levels of transit ridership, walking and bicycling along the corridor. Prior to the construction of additional roadway improvements along the March Lane corridor, the City shall conduct a focused complete streets study to analyze and evaluate peak hour and daily operations of March Lane between I-5 and State Route 99 to identify the cross-section required to accommodate existing and planned growth. The complete streets study shall consider the potential mode shift under scenarios that provide additional bicycle, pedestrian, and transit facilities along the corridor. Should the complete streets study show that corridor operations would fall within the established level of service standard for the six-lane cross-section, an implementation program of the identified bicycle, pedestrian, and transit improvements shall be required. Alternatively, the mitigation measure is to provide an eight-lane cross-section for vehicles. Implementation of this mitigation measure would reduce the potential impact to a <i>less-than-significant</i> level.</li> <li>▪ <b>March Lane between West Lane and Bianchi Road.</b> The adopted</li> </ul> | SU                            |

**EXECUTIVE SUMMARY**

**TABLE 2-1 SUMMARY OF IMPACTS AND MITIGATION MEASURES**

| Environmental Impact | Significance Before Mitigation | Mitigation Measures  | Significance After Mitigation |
|----------------------|--------------------------------|--|-------------------------------|
|                      |                                | <p>2035 General Plan identifies an eight-lane cross section for this roadway from North El Dorado Street to State Route 99. The proposed General Plan envisions a six-lane cross-section through 2040. With an eight-lane cross-section, the roadway would operate within the established LOS policy. Therefore, to mitigate the impact, the City shall reserve sufficient right-of-way to accommodate an eight-lane cross-section, plus associated turn pockets at intersections.</p> <p>Prior to the construction of additional roadway improvements along the March Lane corridor, the City shall conduct a focused complete streets study to evaluate peak hour and daily operations of March Lane between I-5 and State Route 99 to identify the cross-section required to accommodate existing and planned growth. The analysis shall consider the potential mode shift under scenarios that provide additional bicycle, pedestrian, and transit facilities along the corridor. Should corridor operations fall within the established level of service standard with a six-lane cross-section, the study shall identify bicycle, pedestrian, and transit enhancements that are necessary to serve the corridor. Otherwise, the mitigation measure is to provide an eight-lane cross-section for vehicles. Implementation of this mitigation measure would reduce the potential impact to a <i>less-than-significant</i> level.</p> <ul style="list-style-type: none"> <li>▪ <b>Dr. Martin Luther King Jr. Boulevard between I-5 and Airport Way.</b> This section of Dr. Martin Luther King Jr. Boulevard is built out to its ultimate capacity and no further improvements are planned. Provision of parallel capacity in the area would provide alternative travel choices within this area of South Stockton, but is not expected to result in LOS D operations in the Cumulative with Proposed Plan condition. Therefore, this impact would remain <i>significant and unavoidable</i>.</li> <li>▪ <b>8<sup>th</sup> Street between Pock Lane and D Street.</b> This roadway section currently provides one travel lane in each direction with on-street parking within a 60-foot curb-to-curb right-of-way. There is</li> </ul> |                               |

**REPORT SUMMARY**

**TABLE 2-1**      **SUMMARY OF IMPACTS AND MITIGATION MEASURES**

| Environmental Impact | Significance Before Mitigation | Mitigation Measures   | Significance After Mitigation |
|----------------------|--------------------------------|---|-------------------------------|
|                      |                                | <p>sufficient right-of-way to modify the roadway cross-section to maintain on-street parking (8 feet), provide bicycle lanes (6 feet), one travel lane in each direction (10 feet), and a center two-way left-turn lane (12-feet). With modifications within the existing right-of-way, vehicular capacity could increase, reducing the impact to a less-than-significant level. Therefore, to mitigate the impact, the City shall conduct a detailed engineering study of 8<sup>th</sup> Street between El Dorado Street and Mariposa Road to identify roadway improvements that can be implemented within the existing right-of-way to improve travel for all modes, especially considering the potential for a grade-separated crossing of the railroad tracks, which would provide an additional east-west connection in South Stockton. Implementation of this mitigation measure would reduce this impact to <i>a less-than-significant</i> level.</p> <ul style="list-style-type: none"> <li>▪ <b>Arch Airport Road between SR 99 and Quantas Lane.</b> This section of Arch-Airport Road is built out to its ultimate capacity and no further improvements are planned. Provision of parallel capacity in the area would provide alternative travel choices within this area of South Stockton, but is not expected to result in LOS D operations in the Cumulative with Proposed Plan condition. Therefore, this impact would remain <i>significant and unavoidable</i>.</li> <li>▪ <b>California Street between Harding Way and Park Street.</b> Prior to the construction of roadway improvements along the California Street corridor, the City shall conduct a focused complete streets study to evaluate peak hour and daily operations of California Street from north of Harding Way to south of Park Street. The evaluation shall consider the effect of providing exclusive bicycle facilities on peak hour and daily operations along the corridor. The study shall also evaluate parallel roadway facilities that could potentially see an increase in vehicle traffic with a lane reduction on California Street.</li> </ul> <p>Should the study indicate vehicle operations would fall below the level of service standard for the facility, even considering potential traffic shifts to other roadways (and the secondary</p> |                               |

**EXECUTIVE SUMMARY**

**TABLE 2-1 SUMMARY OF IMPACTS AND MITIGATION MEASURES**

| Environmental Impact | Significance Before Mitigation | Mitigation Measures  | Significance After Mitigation |
|----------------------|--------------------------------|--|-------------------------------|
|                      |                                | <p>impact of those shifts), and the potential mode shift to non-auto travel modes, the mitigation measure is to retain the existing vehicle capacity and explore other alternatives for providing bicycle facilities through the corridor. Should the analysis indicate vehicle levels of service would remain within the City’s standard for the roadway facility, the mitigation measure is to construct exclusive bicycle facilities within the existing cross-section. Implementation of this mitigation measure would reduce this impact to a <i>less-than-significant</i> level.</p> <ul style="list-style-type: none"> <li>▪ <b>B Street between Dr. Martin Luther King Jr. Boulevard and 4<sup>th</sup> Street.</b> The City shall reserve sufficient right-of-way to accommodate a four-lane cross-section, plus associated turn pockets at intersections.</li> </ul> <p>Prior to the construction of additional roadway improvements along the B Street corridor, the City shall conduct a focused complete streets study to evaluate peak hour and daily operations of B Street between Dr. Martin Luther King Jr. Boulevard and Arch-Airport Road to identify the cross-section required to accommodate existing and planned growth. The analysis shall consider the potential mode shift under scenarios that provide additional bicycle, pedestrian, and transit facilities along the corridor. Should corridor operations fall within the established level of service standard with a two-lane cross-section, the study shall identify bicycle, pedestrian, and transit enhancements that are necessary to serve the corridor. Otherwise, the mitigation measure is to provide a four-lane cross-section for vehicles. Implementation of this mitigation measure would reduce the potential impact to a <i>less-than-significant</i> level.</p> <p>TRAF-1b: The City shall implement the following to reduce the severity of potential LOS impacts on the following freeway segment:</p> <ul style="list-style-type: none"> <li>▪ <b>State Route 99 between Farmington Road and Fremont Street.</b> The Cumulative with Proposed Plan transportation analysis considers the widening of State Route 99 through Stockton to its ultimate</li> </ul> |                               |

**REPORT SUMMARY**

**TABLE 2-1 SUMMARY OF IMPACTS AND MITIGATION MEASURES**

| Environmental Impact   | Significance Before Mitigation | Mitigation Measures  | Significance After Mitigation |
|--|--------------------------------|--|-------------------------------|
|  |                                | planned width. No additional improvements have been identified. Implementation of the proposed General Plan and its associated policies are expected to provide alternative travel choices to Stockton residents and workers, shifting travel patterns and modes. However, deficient operations are expected to occur on State Route 99, and this impact would remain <i>significant and unavoidable</i> . |                               |
| TRAF-2: Implementation of the proposed General Plan, in combination with regional growth, would result in increased vehicle traffic, which would affect the operation of regional roadways and freeway segments. As discussed above, the proposed General Plan would result in significant level of service impacts to roadway and freeway segments. | S                              | TRAF-2: The City of Stockton shall continue to participate in planning efforts for regional transportation facilities.   | SU                            |
| TRAF-3: Implementation of the proposed Plan would not result in a change in air traffic patterns, including either an increase in traffic levels or a change in location that results in substantial safety risks.   | LTS                            | N/A  | N/A                           |
| TRAF-4: Implementation of the proposed Plan would not substantially increase hazards due to a design feature (e.g., sharp curves or dangerous intersections) or incompatible uses (e.g., farm equipment).  | LTS                            | N/A  | N/A                           |
| TRAF-5: Implementation of the proposed Plan would not result in inadequate emergency vehicle access.   | LTS                            | N/A  | N/A                           |
| TRAF-6: Implementation of the proposed Plan would not conflict with adopted policies, plans, or programs regarding public transit, bicycle, or pedestrian facilities, or otherwise decrease the performance or safety of such facilities.  | LTS                            | N/A  | N/A                           |
| <b>UTILITIES AND SERVICE SYSTEMS</b>   |                                |  |                               |
| UTIL-1: Implementation of the proposed project would have sufficient water supplies available to serve the proposed project from existing entitlements and resources, and would not require new or expanded entitlements.  | LTS                            | N/A  | N/A                           |

## EXECUTIVE SUMMARY

**TABLE 2-1 SUMMARY OF IMPACTS AND MITIGATION MEASURES**

| <b>Environmental Impact</b>  | <b>Significance Before Mitigation</b> | <b>Mitigation Measures</b> | <b>Significance After Mitigation</b> |
|--|---------------------------------------|----------------------------|--------------------------------------|
| UTIL-2: Implementation of the proposed project would not require or result in the construction of new water facilities or expansion of existing facilities, the construction of which would cause significant environmental effects.   | LTS                                   | N/A                        | N/A                                  |
| UTIL-3: Implementation of the proposed project would not exceed wastewater treatment requirements of the CVRWQCB.  | LTS                                   | N/A                        | N/A                                  |
| UTIL-4: Implementation of the proposed project would not require or result in the construction of new wastewater treatment facilities or expansion of existing facilities, the construction of which would cause significant environmental effects.  | LTS                                   | N/A                        | N/A                                  |
| UTIL-5: The City of Stockton Municipal Utilities Department, which would serve the project, has sufficient wastewater treatment capacity to serve the project as well as existing developments in its service area.  | LTS                                   | N/A                        | N/A                                  |
| UTIL-6: Implementation of the proposed project would not require or result in the construction of new storm water drainage facilities or expansion of existing facilities, the construction of which could cause significant environmental effects.  | LTS                                   | N/A                        | N/A                                  |
| UTIL-7: Implementation of the proposed project would be served by landfills with sufficient permitted capacity to accommodate the project's solid waste disposal needs.  | LTS                                   | N/A                        | N/A                                  |
| UTIL-8: Implementation of the proposed project would comply with federal, State, and local statutes and regulations related to solid waste.  | LTS                                   | N/A                        | N/A                                  |
| UTIL-9: Implementation of the proposed project would not result in a substantial increase in natural gas and electrical service demands that would require new energy supply facilities and transmission infrastructure or capacity-enhancing alterations to existing facilities, the construction of which would cause significant environmental effects. | LTS                                   | N/A                        | N/A                                  |

### 3. Revisions to the Draft EIR

---

This chapter includes text revisions to the Draft EIR that were made in response to public, agency, and organization comments, as well as staff-directed changes. These text revisions include typographical corrections, insignificant modifications, amplifications, and clarifications of the Draft EIR. In each case, the revised page and location on the page is presented, followed by the textual, tabular, or graphical revision. Underlined text represents language that has been added to the EIR; text with strikethrough represents language that has been deleted from the Draft EIR. For edits to Chapter 2, Executive Summary, of the Draft EIR, see Chapter 2, Executive Summary, of this Final EIR.

None of the revisions to the Draft EIR constitutes significant new information as defined in CEQA Guidelines Section 15088.5; therefore, the Draft EIR does not need to be recirculated.

**Page 3-17, last paragraph, is amended as follows:**

As shown in Figure 3-4, the proposed revisions to the General Plan land use map would shrink the possible future footprint of the city by changing areas currently designated Village to Open Space/Agriculture. The area proposed to change from Village to Open Space/Agriculture totals approximately ~~9,600~~ 9,000 acres.<sup>5</sup>

**Page 3-18, Figure 3-4, is amended as shown on the following page.**

**Page 3-20, second paragraph, is amended as follows:**

The “full buildout” of the proposed General Plan, ~~discussed~~ is also presented below in Section 3.5.3, Full Buildout Methodology, for information disclosure purposes, as well as to explain the methodology for identifying the projected 2040 development that is evaluated in this EIR. The full buildout presented in that section would be the development of every parcel with the theoretical maximum amount of development ~~allowed that could occur~~ under the General Plan. This “full” theoretical buildout of the General Plan could not be achieved for a variety of reasons. Namely, proposed General Plan Action LU-6.1A caps the amount of development that could occur to the 2040 projections evaluated in this EIR, and, for development that would exceed that cap, requires additional environmental review that addresses growth impacts that would occur due to development exceeding the General Plan EIR’s projections. In addition, proposed General Plan Action LU-6.1B establishes a monitoring program to track the rate of growth and ensure that it does not exceed the amounts analyzed in this EIR.

**Page 3-26, Table 3-3, is amended as shown on page 3-3.**

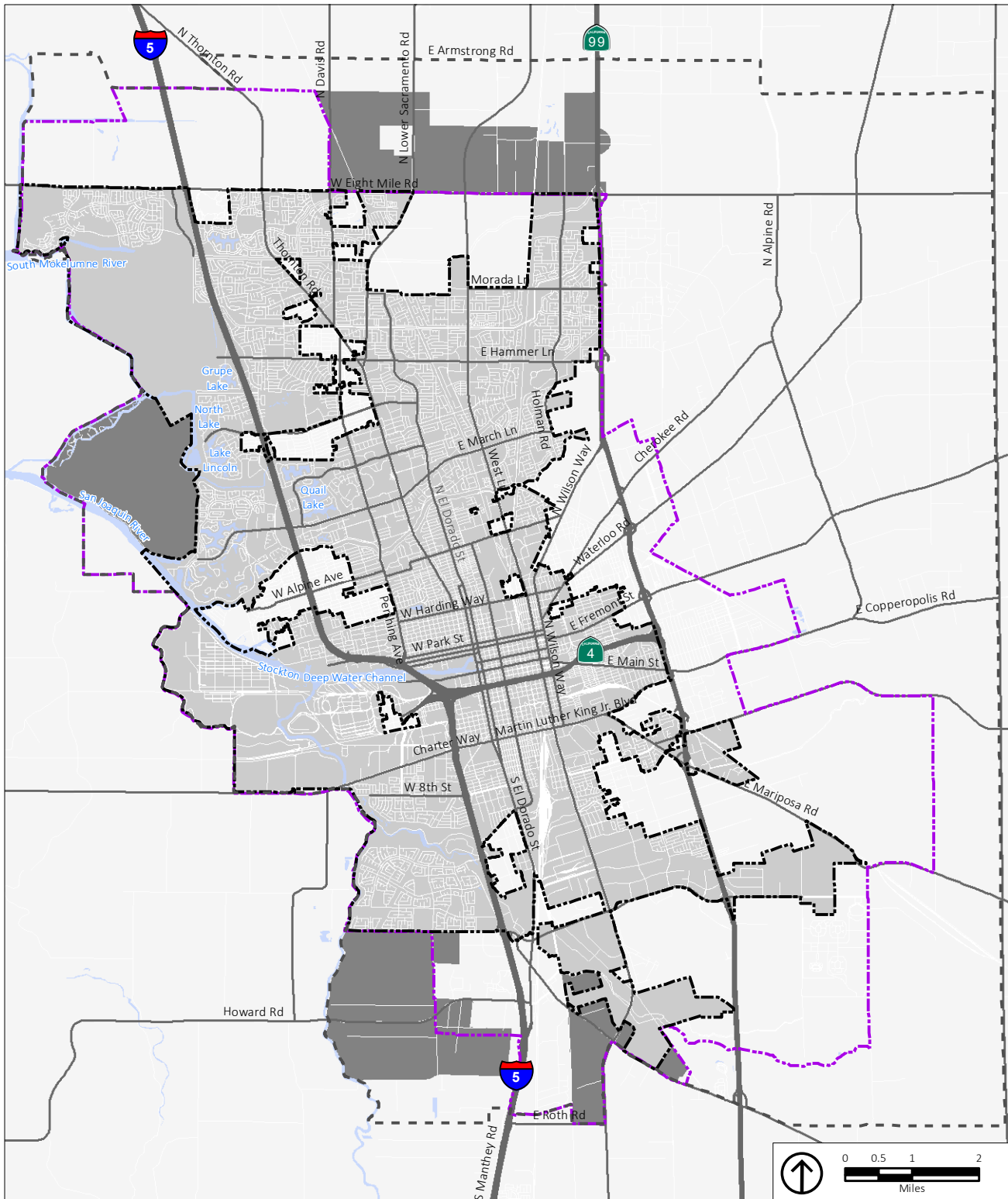

Source: City of Stockton, 2016; Placeworks, 2017.

- Proposed Urban to Open Space Land Use Changes
- City Limit
- Sphere of Influence/ EIR Study Area
- General Plan Planning Area

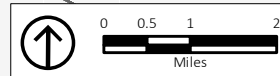

Figure 3-4  
Proposed Urban to Open Space Land Use Changes



**REVISIONS TO THE DRAFT EIR**

**TABLE 3-3 2040 DEVELOPMENT BY STUDY AREA**

| Study Area #/Name                     | <i>Net New<br/>Single-Family<br/>Units<br/>(Full Buildout)</i> | <i>Percent<br/>Applied<br/>to<br/>2040</i> | <b>Net New<br/>Single-Family<br/>Units<br/>(2040)</b> | <i>Net New<br/>Multi-Family<br/>Units<br/>(Full Buildout)</i> | <i>Percent<br/>Applied<br/>to 2040</i> | <b>Net New<br/>Multi-Family<br/>Units<br/>(2040)</b> | <i>Net New<br/>Commercial<br/>Square Feet<br/>(Full Buildout)</i> | <i>Percent<br/>Applied<br/>to 2040</i> | <b>Net New<br/>Commercial<br/>Square Feet<br/>(2040)</b> | <i>Net New<br/>Industrial<br/>Square Feet<br/>(Full Buildout)</i> | <i>Percent<br/>Applied<br/>to<br/>2040</i> | <b>Net New<br/>Industrial<br/>Square Feet<br/>(2040)</b> |
|---------------------------------------|--|--|---|---|--|--|---|--|--|---|--|--|
| 1. Eight Mile Rd                      | 3,940  | 35%  | 1,380   | 25,350  | 5%                                     | 1,200  | 197,000   | 20%                                    | 39,000   | 74,095,000  | 0%   | 0  |
| 2. Pacific Ave Corridor               | 0  | 0%   | 0   | 440   | 25%                                    | 110  | 188,000   | 50%                                    | 94,000   | 0   | 0%   | 0  |
| 3. West Ln and Alpine Rd              | 80   | 100%                                       | 80  | 2,720   | 25%                                    | 680  | 1,294,000   | 25%                                    | 323,000  | 0   | 0%   | 0  |
| 4. Port/Waterfront                    | 20   | 100%                                       | 20  | 2,210   | 80%                                    | 1,770  | 6,800,000   | 30%                                    | 2,040,000  | 2,323,000   | 25%  | 581,000  |
| 5. El Dorado/Center Corridors         | 0  | 0%   | 0   | 1,500   | 80%                                    | 1,200  | 4,367,000   | 30%                                    | 1,310,000  | 0   | 0%   | 0  |
| 6. Miner/Weber Corridors <sup>a</sup> | 0  | 0%   | 0   | 1,560   | 80%                                    | 1,250  | 2,926,000   | 50%                                    | 1,463,000  | 0   | 0%   | 0  |
| 7. Wilson Way Corridor                | 0  | 0%   | 0   | 940   | 25%                                    | 230  | 1,213,000   | 50%                                    | 607,000  | 0   | 0%   | 0  |
| 8. I-5/Highway 4 Interchange          | 0  | 0%   | 0   | 820   | 80%                                    | 660  | 777,000   | 50%                                    | 389,000  | 0   | 0%   | 0  |
| 9. Railroad Corridor at California St | 0  | 0%   | 0   | 1,680   | 80%                                    | 1,340  | 5,197,000   | 25%                                    | 1,299,000  | 0   | 0%   | 0  |
| 10. I-5 and Charter Way               | 90   | 100%                                       | 90  | 980   | 10%                                    | 100  | 535,000   | 25%                                    | 134,000  | 98,000  | 85%  | 84,000   |
| 11. Charter Wy/MLK Jr Blvd Corridor   | 0  | 0%   | 0   | 790   | 50%                                    | 400  | 1,619,000   | 20%                                    | 324,000  | 0   | 0%   | 0  |
| 12. Airport Way Corridor              | 0  | 0%   | 0   | 430   | 25%                                    | 110  | 274,000   | 75%                                    | 205,000  | 5,475,000   | 25%  | 1,369,000  |
| 13. Mariposa and Charter              | 0  | 0%   | 0   | 570   | 0%                                     | 0  | 324,000   | 25%                                    | 81,000   | 0   | 0%   | 0  |
| 14. East Weston Ranch <sup>b</sup>    | 0  | 0%   | 0   | 610   | 0%                                     | 0  | 574,000   | 75%                                    | 431,000  | 0   | 0%   | 0  |
| 15. South of French Camp Rd           | 0  | 0%   | 0   | 0   | 0%                                     | 0  | 0   | 0%                                     | 0  | 0   | 0%   | 0  |
| 16. E French Camp Rd                  | 0  | 0%   | 0   | 0   | 0%                                     | 0  | 0   | 0%                                     | 0  | 0   | 0%   | 0  |
| Outside of Study Areas <sup>c</sup>   | 16,360   | 9%   | 1,500   | 29,810  | 0%                                     | 0  | 19,487,000  | 0%                                     | 0  | 126,805,000   | 0%   | 0  |
| <b>Grand Total<sup>d</sup></b>        |  |  | <b>3,060</b>  |   |  | <b>9,040</b>   |   |  | <b>8,739,000</b>   |   |  | <b>2,033,000</b>   |

Note: To estimate the 2040 development, a percentage of the full theoretical buildout potential was assumed for each study area, as shown in the gray, italicized columns.

a. Excludes Open Window approved project.

b. Excludes Weston Ranch Town Center approved project.

c. Excludes approved/pending projects.

d. Numbers do not always add up due to rounding.

## REVISIONS TO THE DRAFT EIR

Page 4.2-12, new mitigation measure is added:

Significance Without Mitigation: Significant.

**Impact AG-1:** Although the proposed General Plan includes policies and actions that would reduce and partially offset the conversion of farmland, it designates approximately 16,160 acres of farmlands of concern under CEQA for non-agricultural uses.

Mitigation Measure AG-1: Prior to project approval, if a development project will convert prime farmland, farmland of statewide importance, or unique farmland to a non-agricultural use, the project applicant shall demonstrate participation in the City's agricultural conservation program, which requires either dedication of an agricultural conservation easement at a 1:1 ratio or payment of an in-lieu agricultural mitigation fee.

Significance With Mitigation: Conservation easements will not fully mitigate the impact because farmland of concern under CEQA would still be converted to a non-agricultural use. Because these farmland areas are located near existing urbanized areas, they may not be viable for agricultural operations due to conflicts with nearby urbanized areas. The only way to fully mitigate this impact would be to prohibit any development on farmland of concern. CEQA does not require that the project be changed in order to avoid an impact, and much of the farmland of concern that is designated for a non-agricultural use is already entitled for development; no additional mitigation is available, resulting in a *significant and unavoidable* impact.

Significance Without With Mitigation: Significant and unavoidable.

Page 4.3-10, footnote is added:

Applicable SJVAPCD Rules and Regulations<sup>26</sup>

Assembly Bill 170, Reyes

AB 170 was adopted by State lawmakers in 2003, creating Government Code Section 65302.1, which....

---

<sup>26</sup> Specific details on the SJVAPCD rules and regulation can be found here: <http://www.valleyair.org/rules/1ruleslist.htm>.

Page 4.3-32, second paragraph, is amended as follows:

As part of the development process, individual, site-specific projects accommodated under the proposed General Plan that meet the criteria of SJVAPCD Rule 9510 would be required to prepare a detailed air quality impact assessment (AIA). To the extent applicable under Rule 9510 for each such individual development, SJVAPCD would require calculation of the construction emissions from the development. The purpose of the AIA is to confirm a development's construction exhaust emissions, and therefore be able to identify appropriate mitigation, either through implementation of specific mitigation measures (e.g., use of construction equipment with Tier 4-rated engines) or payment of applicable off-site fees. As stated, under Rule 9510, each project that is subject to this Rule would be required to reduce construction

## REVISIONS TO THE DRAFT EIR

exhaust emissions by 20 percent for NO<sub>x</sub> or pay offset mitigation fees for emissions that do not achieve the mitigation requirements. In addition to Rule 9510, future individual projects would also be subject to other regulatory measures such as SJVAPCD Rules 4101 (limits visible emissions) and 4601 (limits VOC content of paints used) and Regulation VIII, and CARB's Airborne Toxic Control Measures.<sup>47</sup> Furthermore, the proposed General Plan includes Action SAF-4.1.C, which requires use of electric-powered construction equipment when appropriate. Nevertheless, while adherence to existing and proposed regulations may reduce short-term emissions, the likely scale and extent of construction activities associated with the proposed General Plan and UMPS would likely continue to exceed the SJVAPCD thresholds for some projects. Therefore, construction-related regional air quality impacts associated with implementation of the proposed project are deemed *significant*.

---

<sup>47</sup> For details regarding Regulation VIII, see the Fugitive PM<sub>10</sub> Prohibitions discussion under Applicable SJVAPCD Rules and Regulations above.

### Page 4.3-33 to 4.3-34, Mitigation Measure AQ-2, is amended as follows:

- Operations shall limit or expeditiously remove the accumulation of mud or dirt from adjacent public streets at the end of each workday. (The use of dry rotary brushes is expressly prohibited except where preceded or accompanied by sufficient wetting to limit the visible dust emissions.) (Use of blower devices is expressly forbidden.) (Utilize electric-powered vacuums or devices to capture materials.)

### Page 4.3-38, Mitigation Measure AQ-3, is amended as follows:

- Applicants for future development projects along existing and planned transit routes shall coordinate with the City Stockton and San Joaquin Regional Transit District to ensure that bus pad and shelter improvements are incorporated, as appropriate, and that these transit improvements consider and implement design features (e.g., pullout lanes for buses) to avoid or reduce impediment/queuing of vehicles.

### Page 4.7-30, first paragraph, is amended as follows:

....2040 Plan-Level efficiency metric. As discussed in Section 4.7.2.1, a 2040 efficiency target was derived for the proposed project based on the horizon year and the 2030 goal established in SB 32 and the 2050 climate stabilization goal established under Executive Order S-03-05. Also, as stated in Section 4.7.2.1, because the 2040 Plan-Level efficiency metric is used to gauge whether the proposed project would also progress towards achieving the long-term 2050 reduction goal, the proposed project would also not meet the 2050 climate stabilization target of 1.2 MTCO<sub>2</sub>e/SP. In order to show progress in progressing towards meeting the 2050 goal, based on the forecasted 2040 efficiency metric of 2.61 MTCO<sub>2</sub>e/yr/SP and the projected service population of 597,200 persons in the horizon year, the total community emissions for the City cannot exceed 1,558,692 MTCO<sub>2</sub>e/yr in 2040. Furthermore, additional federal, State, and local GHG reductions would be needed to achieve the 2050 Plan-Level efficiency target and the State's climate stabilization goals; consequently, the impact is considered *significant*.

## REVISIONS TO THE DRAFT EIR

Page 4.8-9 is amended as follows:

### *Stockton Metropolitan Airport Land Use Compatibility Plan*

The Airport Land Use Compatibility Plan (ALUCP) for the Stockton Metropolitan Airport was last updated in May 2016.<sup>6</sup> The ALUCP provides guidance related to the placement of land uses near the Stockton Metropolitan Airport. Specifically, the ALUCP seeks to protect the public from adverse effects of aircraft noise, ensure that people and facilities are not concentrated in areas susceptible to aircraft accidents, and ensure that no structures or activities adversely affect navigable airspace. The safety zones in the ALUCP are described in detail below in Section 4.8.1.2.

### Countywide Airport Land Use Compatibility Plan

The Countywide Airport Land Use Compatibility Plan addresses all other airports in San Joaquin County, including Kingdon Airpark and Lodi Precissi Airpark, which have a combined airport influence area that extends into the EIR study area, north of the city limit. The Plan, which was last updated in January 2018,<sup>7</sup> provides guidance related to the placement of land uses near the Kingdon Airpark and Lodi Precissi Airpark. As with the Stockton Metropolitan ALUCP, the Countywide ALUCP seeks to protect the public from adverse effects of aircraft noise, ensure that people and facilities are not concentrated in areas susceptible to aircraft accidents, and ensure that no structures or activities adversely affect navigable airspace. The safety zones in the Countywide ALUCP for Kingdon Airpark and Lodi Precissi Airpark are described in detail below in Section 4.8.1.2.

---

<sup>7</sup> San Joaquin County's Aviation System, Airport Land Use Compatibility Plan Update, <https://www.sicog.org/DocumentCenter/View/17/2009-San-Joaquin-County-ALUCP---Amended-January-2018?bidId=>, accessed August 23, 2018.

Page 4.8-20, Figure 4.8-2, is amended as shown on the following page:

Page 4.8-21 is amended as follows:

...

- **Zone 8, Airport Influence Area.** There are no limits on residential density within this zone.

The Kingdon Airpark and Lodi Precissi Airpark are located north of the city limit. Their combined total AIA is 29,387 acres; of this total acreage, 2,484 acres are within the northwest portion of the EIR study area. Compatibility Zones 7 and 8 of the Kingdon Airpark and Compatibility Zone 8 of the Lodi Precissi Airpark fall within the EIR Study Area, as shown in Figure 4.8-2.

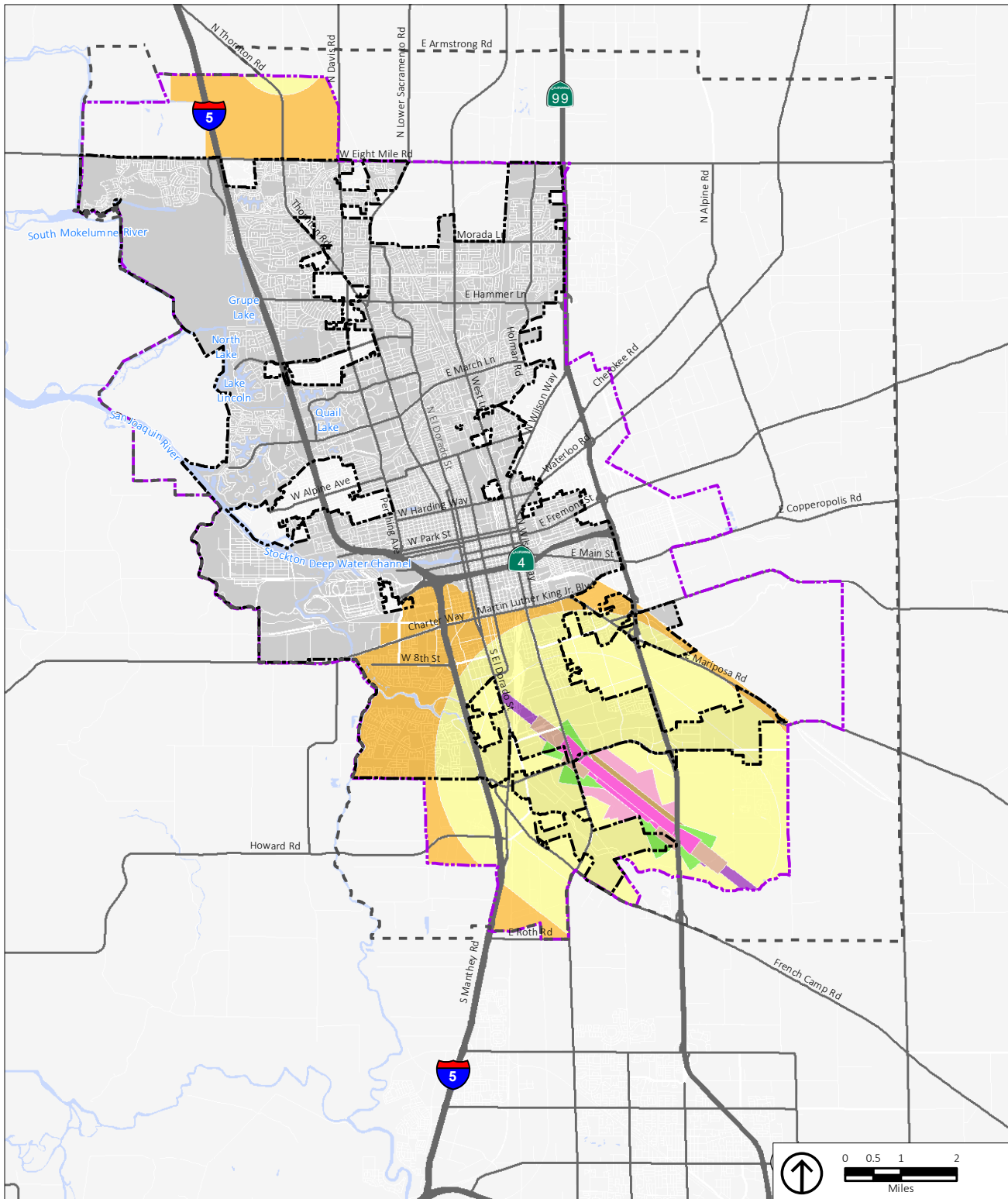

Source: City of Stockton; San Joaquin County; PlaceWorks, 2017.

- |  |   |   |
|--|---|---|
| <ul style="list-style-type: none"> <li> General Plan Planning Area</li> <li> City Limit</li> <li> Sphere of Influence/ EIR Study Area</li> </ul> | <p><b>Safety Zones</b></p> <ul style="list-style-type: none"> <li> Zone 1, Runway Protection Zone</li> <li> Zone 2, Inner Approach/Departure Zone</li> <li> Zone 3, Inner Turning Zone</li> <li> Zone 4, Outer Approach/Departure Zone</li> </ul> | <ul style="list-style-type: none"> <li> Zone 5, Sideline Safety Zone</li> <li> Zone 6, Airport Property Zone</li> <li> Zone 7, Traffic Pattern Zone</li> <li> Zone 8, Airport Influence Area</li> </ul> |
|--|---|---|

Figure 4.8-2  
Airport Safety and Compatibility Zones

## REVISIONS TO THE DRAFT EIR

Page 4.8-25 is amended as follows:

The Stockton Municipal Airport is located immediately south of the city limit. As described above and shown on Figure 4.8-2, the EIR Study Area falls within Stockton Municipal Airport Safety Zones 1 through 8. Safety Zones 1 through 6 establish limits on residential uses and densities, along with other development restrictions, while Safety Zones 7 and 8, which cover a larger area, do not establish limits on residential densities. The proposed General Plan designates the area within Safety Zones 1 through 6 as Public and Industrial, which are uses that are consistent with these Safety Zones.

In addition, the Kingdon Airpark and Lodi Precissi Airpark are located north of the city limit. As described above and shown on Figure 4.8-2, the EIR Study Area falls within Kingdon Airpark Compatibility Zones 7 and 8 and Lodi Precissi Airpark Compatibility Zone 8. Compatibility Zones 7 and 8 do not establish limits on residential densities or uses. Zone 7 establishes a restriction on the intensity of non-residential uses (a limit of 450 persons per acre), while Zone 8 does not establish a restriction on the intensity of non-residential uses. The proposed General Plan designates the area within Compatibility Zones 7 and 8 as Economic and Education Enterprise, which is a designation that could be developed within the non-residential use intensity limit.

....

Given that the proposed General Plan designates land for uses that are compatible with the safety requirements of the Stockton Municipal Airport and Countywide ALUCPs, and that future development would be subject to existing Stockton Municipal Code Chapter 16.28 requirements as well as proposed General Plan requirements about development within the AIAs, the impact would be *less than significant*.

Page 4.9-7 is amended as follows:

### *Sustainable Groundwater Management Act*

The Sustainable Groundwater Management Act (SGMA) of 2014, consisting of SBs 1168 and 1319 and Assembly Bill 1739, requires groundwater-dependent regions to halt overdraft and bring basins into balanced levels of pumping and recharge. The legislation requires ~~that a~~ Groundwater Sustainability Agency (GSA) be established in high and medium priority basins by July 1, 2017 and that a Groundwater Sustainability Plan (GSP) be adopted for the most important groundwater basins in California by January 31, 2020. This legislation provides opportunities for basins to be managed at a local level to collaboratively address unique basin conditions and challenges. GSPs must include a description of the physical setting and characteristics of the aquifer system, measurable objectives to achieve sustainability within 20 years, an implementation horizon, and monitoring protocols. Plan coordination, public notification, and annual reporting are also important plan elements.

The City of Stockton is within a high priority basin and formed the City of Stockton GSA on December 8, 2015, which covers the incorporated areas of Stockton. As a local agency, the City of Stockton GSA is required to create a GSP and perform the necessary powers of a GSA when developing, implementing, and enforcing the basin's GSP. According to SGMA, a GSA has the authority to impose well construction requirements, control groundwater extraction, authorize transfers of groundwater extractions, and establish groundwater accounting rules in conjunction with regulations established in the GSP. The City of

## REVISIONS TO THE DRAFT EIR

Stockton GSA is currently in the process of drafting a GSP and has submitted GSP Initial Notifications to the California Department of Water Resources.

The GSA surrounding the City of Stockton is the San Joaquin County GSA, which was formed on December 15, 2015 and consists of unincorporated county lands in the Stockton area that receive water services from CalWater. The County and CalWater have signed a Memorandum of Agreement (MOA) that provides a mechanism for CalWater to participate with the other GSAs in developing the GSP within the Eastern San Joaquin Subbasin. The MOA does not convey to CalWater any of the County's SGMA authorities. The San Joaquin County GSA is currently in the process of drafting a GSP and has submitted GSP Initial Notifications to the California Department of Water Resources. A Stakeholder Work Group has formed and the first public meeting occurred on August 29, 2018 for the Plan development.

~~a Groundwater Sustainability Plan (GSP) be adopted for the most important groundwater basins in California; establishes a timetable for adoption of GSPs; empowers local agencies to manage basins sustainably; and establishes basic requirements for GSPs.~~

Page 4.9-12 is amended as follows:

Numerous water bodies in the EIR Study Area are listed on the CWA Section 303(d) List of Water Quality Limited Segments. Listed water bodies include the Stockton Ship Channel, San Joaquin River, Pixley Slough, Bear Creek, Mosher Slough, Calaveras River, Mormon Slough, Duck Creek, French Camp Slough, and Littlejohns Creek. Pollutants include organochlorine pesticides (dioxin, DDT [dichlorodiphenyl-trichloroethane], Group A pesticides, and diuron); organophosphate pesticides (chlorpyrifos, diazinon, and disulfoton); polychlorinated biphenyls (PCBs); pathogens and bacteria; heavy metals (copper and mercury); unknown toxicity; sediment toxicity; organic enrichment/low dissolved oxygen; dissolved oxygen; and invasive species.<sup>12</sup>

The City of Stockton & County of San Joaquin National Pollutant Discharge Elimination System Municipal Stormwater Program 2016-2017 Annual Report (Annual Report) provides a summary of the results of the City's 2016-2017 water quality monitoring at stormwater outfalls and in the receiving water (Calaveras River). Most of the stormwater monitoring results complied with the allowable water quality objectives (WQOs), but some exceedances occurred, as illustrated by the following quotes from the Annual Report:

- "E. coli concentrations in receiving water sites are below the WQO in almost all samples, but showed occasional exceedances at discharge sites." (page 19)
- "Chlorpyrifos concentrations were all below the WQO, and were frequently non-detect, except for the first storm sample (SE61) at discharge site CR-41." (page 19)
- "A higher number of individual pyrethroid compounds, and higher concentrations of pyrethroids, were detected in discharge samples than receiving water samples." (page 20)
- Related to dissolved oxygen (DO): "DO concentrations were appropriately above the minimum WQO in all receiving water grab samples. Concentrations in discharge samples were lower during storm events than during wet weather events. Concentrations below the minimum WQO were observed during dry weather events at CR-42, and during the first dry weather event at CR-46 and CR-39." (page 20)

## REVISIONS TO THE DRAFT EIR

- Related to sediment toxicity: “Samples from both storm events showed significant toxicity, and triggered follow up testing of sediment chemistry.” (page 34)

Additional specific stormwater monitoring results, discussion, and analysis, are available in the Annual Report. In addition, as summarized on page 1 of the Annual Report, a goal of the City’s stormwater program is to control the discharge of pollutants from the municipal storm drain system to the Maximum Extent Practicable (MEP) and include a wide range of BMPs.

To help accomplish this goal, the City’s 2016-2017 NPDES expenditure was \$5.3 million, and the 2017-2018 expenditure was estimated at \$7.2 million (page 3 of the Annual Report).

**Page 4.9-13 is amended as follows and new Figure 4.9-3.1 is shown on following page:**

The Eastern San Joaquin Subbasin is recharged by water from sources including streams, percolation of rainfall and irrigation water, inflow from other groundwater basins, and intentional recharge at numerous facilities. Intentional recharge is conducted in recharge ponds and on some farm fields with compensation to landowners.<sup>17</sup>

The California Soil Research Lab at UC Davis and the University of California Division of Agriculture and Natural Resources has mapped a Soil Agricultural Groundwater Banking Index (SAGBI), which is a suitability index for groundwater recharge on agricultural land. The SAGBI is based on five major factors that are critical to successful agricultural groundwater banking: deep percolation, root zone residence time, topography, chemical limitations, and soil surface condition. The SAGBI suitability rankings for the EIR Study Area are shown in Figure 4.9-3.1.

**Page 4.9-25, Table 4.9-2, is amended as follows:**

**TABLE 4.9-2 EXISTING AND FORECAST WATER SUPPLIES BY SOURCE, EIR STUDY AREA**

| Source  |  | 2015           |                           | 2040           |                           |
|---|--|----------------|---------------------------|----------------|---------------------------|
|   |  | Supplies (afy) | Percent of Total Supplies | Supplies (afy) | Percent of Total Supplies |
| Purchased Water – Calaveras, Stanislaus, and Mokelumne rivers | <del>California Water Service Company (CWSC)</del>   | 15,350         | –                         | 24,000         | –                         |
|   | <del>City of Stockton Municipal Utilities Dept. (COSMUD)</del>   |                |                           |                |                           |
|   | <del>City of Stockton Municipal Utilities Dept. (COSMUD) California Water Service Company (CWSC)</del> | 8,787          | –                         | 19,000         | –                         |
|   | <i>Total</i>   | <i>24,137</i>  | <i>51%</i>                | <i>43,000</i>  | <i>35%</i>                |
| Surface Water (San Joaquin Delta)                             | COSMUD   | 9,428          | 20%                       | 50,000         | 41%                       |
| Groundwater   | <del>COSMUD</del> <del>CWSC</del>  | 6,740          | –                         | 6,740          | –                         |
|   | <del>CWSC</del> <del>COSMUD</del>  | 6,628          | –                         | 23,100         | –                         |
|   | <i>Total</i>   | <i>13,368</i>  | <i>28%</i>                | <i>29,840</i>  | <i>24%</i>                |
| <b>Total Water Supplies</b>                                   |  | <b>46,933</b>  | <b>100%</b>               | <b>122,840</b> | <b>100%</b>               |

Note: afy = acre-feet per year

Sources: California Water Service Company (CWSC) Stockton District. 2016. 2015 Urban Water Management Plan. City of Stockton. 2016. 2015 Urban Water Management Plan.



HYDROLOGY AND WATER QUALITY

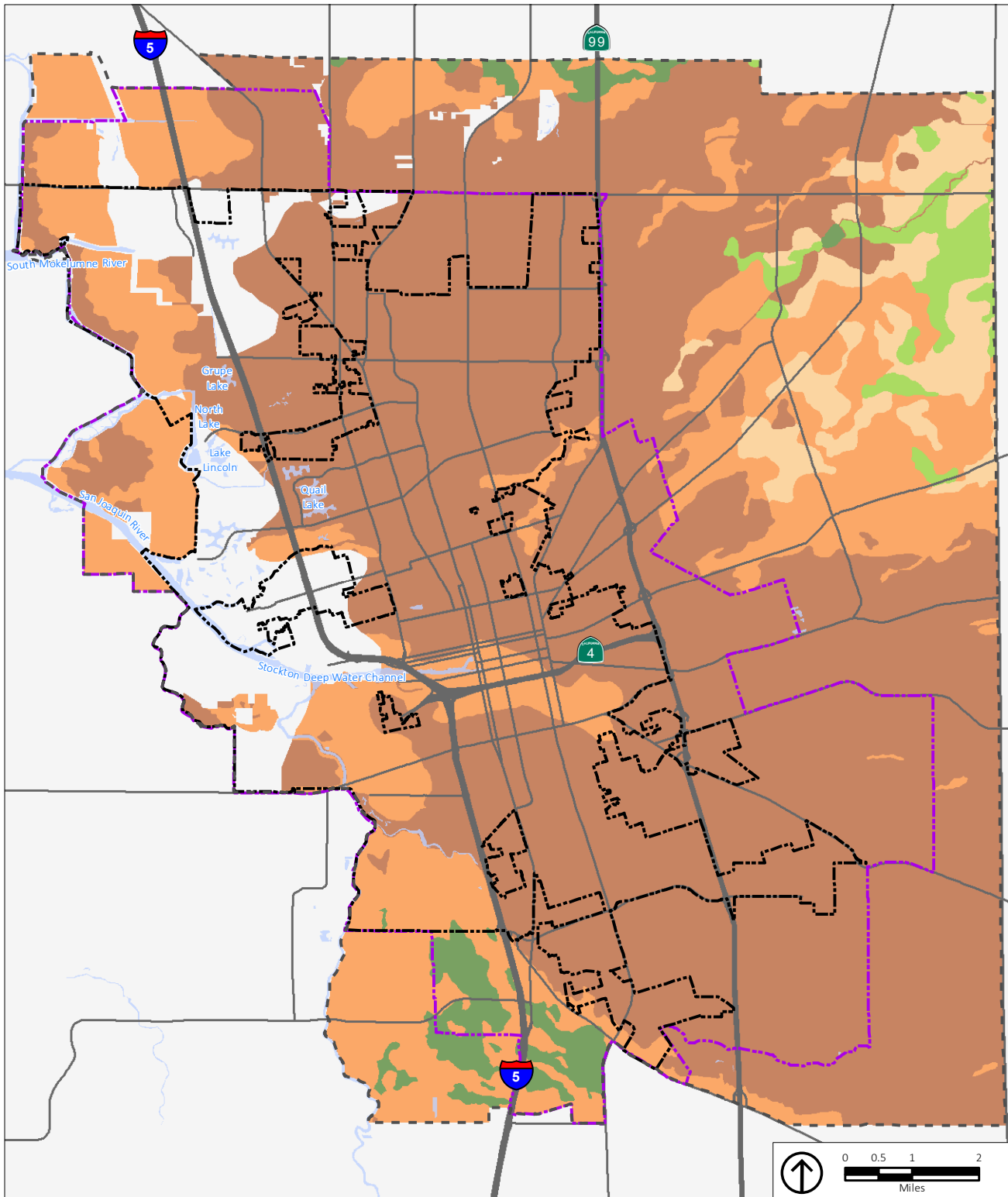

Source: Soil Agricultural Groundwater Banking Index (SAGBI), UC Davis, 2018; City of Stockton, 2016; Placemarks, 2017.

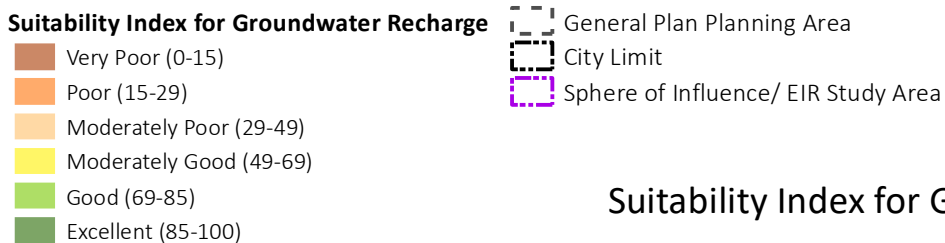

Figure 4.9-3.1

Suitability Index for Groundwater Recharge

## REVISIONS TO THE DRAFT EIR

### Page 4.9-26 is amended as follows:

Intentional groundwater recharge is conducted at numerous facilities in San Joaquin County, including recharge ponds and on some farm fields temporarily used for recharge. Recharge ponds are required for maintaining both municipal and agricultural water supplies. The proposed General Plan does not designate these recharge ponds for other land uses, so they would be maintained under the proposed General Plan.

In addition, as shown in Figure 4.9-3.1, the majority of the EIR Study Area is ranked as poor to very poor suitability for groundwater recharge, according to the SAGBI, although there are some areas ranked as excellent in the southern portion of the EIR Study Area.

Future development allowed under the proposed General Plan would increase the total amount of impervious areas in the EIR Study Area, which could reduce the opportunity for groundwater recharge, including in areas that are ranked as excellent suitability for groundwater recharge by the SAGBI. However, priority projects would be required to implement multiple BMPs that minimize impervious areas and retain, reuse, and/or infiltrate stormwater, as described above in Section 4.9.1.1. In addition, proposed General Plan Action SAF-3.2.B requires new development to employ LID approaches that conserve natural areas and reduce impervious areas. Therefore, groundwater recharge impacts would be *less than significant* after implementation of BMPs required by the City of Stockton.

### Page 4.9-29, Mitigation Measure HYDRO-5, is amended as follows:

**Mitigation Measure HYDRO-5:** Complete a citywide storm drainage master plan, including hydrologic and hydraulic models for existing land use conditions and for the land uses anticipated in 2040 under the proposed General Plan. The master plan should identify the future stormwater infrastructure needs and develop a current stormwater capital improvement plan. As part of this process, identify areas that have constraints, prioritize watersheds to be modeled, and evaluate the City stormwater fee program for potential revisions. In addition, require new development to complete stormwater plans covering drainage, flood control, and storm water quality/permitting. Use the master plan and project-level stormwater plans to assess future development, and require that future development construct the required on- and off-site infrastructure. Implementation of this mitigation measure should be timed to anticipate and precede significant developments that would be most likely to place large demands on the current stormwater system.

### Page 4.10-3 is amended as follows:

#### *Stockton Metropolitan Airport Land Use Compatibility Plan*

The Airport Land Use Compatibility Plan (ALUCP) for the Stockton Metropolitan Airport was last updated in May 2016.<sup>2</sup> The ALUCP provides guidance related to the placement of land uses near the Stockton Metropolitan Airport. Specifically, the ALUCP seeks to protect the public from adverse effects of aircraft noise, ensure that people and facilities are not concentrated in areas susceptible to aircraft accidents, and ensure that no structures or activities adversely affect navigable airspace.

## REVISIONS TO THE DRAFT EIR

### Countywide Airport Land Use Compatibility Plan

The Countywide Airport Land Use Compatibility Plan addresses all other airports in San Joaquin County, including Kingdon Airpark and Lodi Precissi Airpark, which have a combined airport influence area that extends into the EIR study area, north of the city limit. The Plan, which was last updated in January 2018,<sup>3</sup> provides guidance related to the placement of land uses near the Kingdon Airpark and Lodi Precissi Airpark. As with the Stockton Metropolitan ALUCP, the Countywide ALUCP seeks to protect the public from adverse effects of aircraft noise, ensure that people and facilities are not concentrated in areas susceptible to aircraft accidents, and ensure that no structures or activities adversely affect navigable airspace.

<sup>3</sup> San Joaquin County's Aviation System, Airport Land Use Compatibility Plan Update, <https://www.sicog.org/DocumentCenter/View/17/2009-San-Joaquin-County-ALUCP---Amended-January-2018?bidId=>, accessed August 23, 2018.

Page 4.10-4 is amended as follows:

The Delta Plan, adopted by the Delta Stewardship Council on May 16, 2013, is a comprehensive long-term management plan for the Sacramento-San Joaquin River Delta. The Delta Plan includes rules and recommendations that support the State's goals for the Delta to: (1) improve water supply; (2) protect and restore a vibrant and healthy Delta ecosystem; and (3) preserve, protect, and enhance the unique agricultural, cultural, and recreational characteristic of the Delta. The 14 regulatory policies in the Delta Plan are enforceable through regulatory authority included in the Delta Reform Act, enacted as part of Senate Bill X7. These policies include a requirement for Delta Plan consistency findings for "covered actions," which include the proposed General Plan. The Delta Plan covers the Legal Delta (shown on Figure 4.9-2, *Sacramento-San Joaquin Delta*, of this EIR) and Suisun Marsh, an area west of the central part of the Legal Delta.

### Land Use and Resource Management Plan

The Land Use and Resource Management Plan for the Primary Zone of the Delta, adopted by the Delta Protection Commission on February 25, 2010, includes a policy framework to protect, maintain, and where possible, enhance and restore the overall quality of the Delta environment, including but not limited to agriculture, wildlife habitat, and recreational activities; assure orderly, balanced conservation and development of Delta land resources; and improve flood protection by structural and nonstructural means to ensure an increased level of public health and safety. General plans and projects within the five Delta counties, including San Joaquin County, must be consistent with the Management Plan, and are subject to review by the Delta Protection Commission.

Page 4.10-16 is amended as follows:

### **Stockton Metropolitan Airport Land Use Compatibility Plans**

The Stockton Municipal Airport is located immediately south of the city limit, and the Kingdon Airpark and Lodi Precissi Airpark are located north of the city limit. The southwest portion of the EIR Study Area falls within the Stockton Metropolitan Airport Land Use Compatibility Plan safety zones, and the northwest

## REVISIONS TO THE DRAFT EIR

portion of the EIR Study Area falls within the Kingdon Airpark and Lodi Precissi Airpark Land Use Compatibility Plan zones, which are shown on Figure 4.8-2, *Stockton Metropolitan Airport Safety Zones*, of this EIR, and include the following:

....

- **Zone 8, Airport Influence Area.** There are no limits on residential density within this zone.

The proposed General Plan designates the area within the Stockton Metropolitan Airport Land Use Compatibility Plan Safety Zones 1 through 6 as Public and Industrial, which are uses that are consistent with these Safety Zones. The proposed General Plan designates the area within Compatibility Zones 7 and 8 for the Kingdon Airpark and Lodi Precissi Airpark as Economic and Education Enterprise, which is also a use that is consistent with these Compatibility Zones. Compatibility Zone 7 establishes a restriction on the intensity of non-residential uses (a limit of 450 persons per acre), but the Economic and Education Enterprise designation can be developed within that limit.

**Page 4.10-17 is amended as follows:**

In addition, new development under the proposed General Plan would be subject to Stockton Municipal Code Chapter 16.28, which requires that uses be consistent with the Stockton Municipal Airport Land Use Compatibility Plan.

Because the proposed General Plan land use map is consistent with the Stockton Metropolitan Airport Land Use Compatibility Plan safety zones and the Countywide Airport Land Use Compatibility Plan compatibility zones, and proposed General Plan actions promote consistency, the impact would be *less than significant*.

**Page 4.11-23 is amended as follows:**

*Aircraft Noise*

### Stockton Metropolitan Airport

The ~~only public airport in the EIR Study Area is the~~ Stockton Metropolitan Airport (identifier code SCK), located in the southern portion of the study area.<sup>9</sup> The main runway is oriented northwest to southeast. The receptor areas to the northwest of the airport are primarily commercial and industrial land uses, while the receptor areas to the southeast of the airport are almost exclusively agricultural uses.

Based on the noise contour maps related to the Stockton Metropolitan Airport,<sup>10</sup> the projected 60 dBA CNEL contour extends no more than 1.52 miles to the northwest of the airport facility and the 65 dBA CNEL contour extends approximately 0.79 miles from the airport (both distances are with respect to the end of the runway). There are no residential developments within either the 65 or 60 dBA CNEL contours (see the discussion regarding the State's Airport Noise Standards in Section 4.11.1.2).

## REVISIONS TO THE DRAFT EIR

### Kingdon Airpark

The Kingdon Airpark is located directly north of the EIR Study Area within an unincorporated portion of San Joaquin County. Kingdon Airpark has one runway that is oriented northwest to southeast and overlaid with asphalt. The receptor areas to the northwest of the airport are primarily agricultural uses with some single-family residential development located along Devries Road. The receptor areas to the south and southeast of the airport are almost exclusively agricultural uses.<sup>11</sup> There are no residential developments within the Kingdon Airpark noise contours.<sup>12</sup>

### Lodi Precissi Airpark

The Lodi Precissi Airpark, located in the northern portion of the EIR Study Area, has one runway that is oriented east to west. The receptor areas to the east of the airport are primarily agricultural, commercial, and single-family residential land uses. The receptor areas to the west of the airport are primarily agricultural uses with some single-family residential development.<sup>13</sup> There are no residential developments within Lodi Precissi Airpark noise contours.<sup>14</sup>

<sup>11</sup> San Joaquin County's Aviation System, Airport Land Use Compatibility Plan, January 2018, pages 2-7 to 2-11.

<sup>12</sup> San Joaquin County's Aviation System, Airport Land Use Compatibility Plan, January 2018, Exhibit 2KA-2.

<sup>13</sup> San Joaquin County's Aviation System, Airport Land Use Compatibility Plan, January 2018, pages 2-13 to 2-17.

<sup>14</sup> San Joaquin County's Aviation System, Airport Land Use Compatibility Plan, January 2018, Exhibit 2LP-3.

### **Page 4.11-52 is amended as follows:**

The only public airport in the EIR Study Area is the Stockton Metropolitan Airport, which is located in its within the southern portion for the EIR Study Area.<sup>22</sup> Based on the noise contour maps for the Stockton Metropolitan Airport,<sup>23</sup> the projected 60 dBA CNEL contour extends no more than 1.52 miles to the northwest of the airport facility and the 65 dBA CNEL contour extends approximately 0.79 miles from the airport (both distances are with respect to the end of the runway). The Kingdon Airpark and Lodi Precissi Airpark have a combined airport influence area that extends into the EIR Study Area, north of the city limit. As discussed above in Section 4.11.1.3, there are no residential developments within the Kingdon Airpark and Lodi Precissi Airpark noise contours.

The entirety of the EIR Study Area within the 60 dBA CNEL contour for the Stockton Metropolitan Airport is industrial land use; the proposed General Plan does not include new residential land uses within the 65 or 60 dBA CNEL contours (see the discussion regarding the State's Airport Noise Standards in Section 4.11.1.2). According to the proposed General Plan, the maximum allowable ambient noise exposure (shown in Table 4.11-10) for industrial land uses is 80 dBA  $L_{dn}$ .<sup>23</sup> The entire 80 dBA CNEL contour for the Stockton Metropolitan Airport is contained within the airport property and does not affect any nearby industrial land uses. In addition, the proposed General Plan does not include new residential land uses within the Kingdon Airpark and Lodi Precissi Airpark noise contour areas.

Further, the proposed General Plan includes Action TR-1.3.A, which requires that development around the Stockton Metropolitan Airports be consistent with the noise standards contained in the approved Airport Land Use Plan.

## REVISIONS TO THE DRAFT EIR

Existing and future land uses within the EIR Study Area will not be exposed to increased noise from the Stockton Metropolitan Airport, Kingdon Airpark, or Lodi Precissi Airpark noise contours. Therefore, the impact would be *less than significant*.

Page 4.14-23 is amended as follows:

RCMP facilities within the EIR Study Area include:

- Interstate 5
- State Route 99
- State Route 4
- State Route 88
- State Route 26
- Eight Mile Road
- Hammer Lane
- March Lane
- Sperry Road
- French Camp Road
- Trinity Parkway
- Thornton Road
- Pacific Avenue
- West Lane
- Airport Way
- Mariposa Road
- Austin Road
- Lower Sacramento Road
- Arch Road
- Navy Drive
- Roth Road
- Jack Tone Road
- Matthews Road

Page 4.14-39 is amended as follows:

- ....
- **Action TR-3.1.C:** Preserve right-of-way for transit and bicycle uses when designing new roadways and improving existing roadways.

In addition, the 2008 Settlement Agreement on the Stockton 2035 General Plan, which is described on page 4.7-19 and 4.10-5, calls for the development of a transit program based on a transit gap study. The agreement calls upon the City to 1) conduct the transit gap study, which was completed in 2010; and 2) develop a transit gap program, which was also completed. The 2010 Transit Gap Study evaluated four types of Transit Gaps, with key findings summarized below:

1. **Geographic Gaps** – Geographic coverage of the service area is adequate to serve the demand. Aside from future development and addressing certain geographic barriers, no existing areas in the SJRTD system require additional transit coverage. Resources should be invested in improving service quality.
2. **Transit Service Quality Gaps** – Positive qualities of transit service in Stockton include the current Metro Express Bus Rapid Transit (BRT) route, service provided at appropriate times of the day or week, and high-quality passenger information. Areas for improvement include overall infrequent service, low service reliability, and complicated bus routes. These areas for improvement should be addressed to improve the attractiveness of the service to potential passengers.
3. **Policy Gaps** – 2035 General Plan policies address the role of transit but may not go far enough in stressing the importance of a robust local transit network. General Plan development policies should also lay out more specific information regarding transit-friendly urban design strategies.

## REVISIONS TO THE DRAFT EIR

4. **Funding Gaps** – Current transit funding sources are dwindling and are not adequate to provide for improvements necessary in the network. The City should look to increase sustainable transit funding, either by assessing fees on new development or other tax measures.

The proposed General Plan contains the following actions related to closing each of the gaps:

### 1. **Geographic Gaps**

- Action CH-2.1F: Work with transit agencies to maintain and improve transit service in underserved and disadvantaged neighborhoods to connect residents with jobs, shopping, and services.
- Action LU-2.5A: Improve transit, bicycle, and pedestrian connectivity between the Downtown and local colleges and universities.

### 2. **Transit Service Quality Gaps**

- Action TR-1.1B: Maintain and periodically update a schedule for synchronizing traffic signals along arterial streets and freeway interchanges to facilitate the safe and efficient movement of people and goods and to provide signal priority for transit vehicles at intersections.
- Action TR-1.2B: Support the San Joaquin Regional Transportation District’s Regional Bus Service, Altamont Commuter Express (ACE), and Amtrak’s San Joaquin intercity rail service, and pursue and support other regional transit programs and projects.
- Action TR-2.2C: Request that public transit service providers expand routes and increase frequency and operational hours consistent with current short- and long-range transit planning, as financially feasible.

### 3. **Policy Gaps**

- Action TR-2.2A: Require major new development to incorporate design features to promote safe and comfortable access to transit, such as a circulation network that facilitates efficient and connected bus travel, clear pedestrian and bicycle routes connecting origins and destinations to transit stops, sheltered bus stops, park-and-ride facilities, and highly visible transit information and maps.
- Action TR-2.2B: Obtain input from local and regional transit operators on major new development projects to ensure projects are designed to support transit and provide adequate transit service and access.
- Action CH-2.2B: Establish Transit Oriented Development (TOD) Overlay Zones around the Robert J. Cabral ACE Train Station and the San Joaquin Street Amtrak Station to promote high-density residential, including affordable and mixed-income housing, and other TOD.

### 4. **Funding Gaps**

- Action LU-6.5C: Evaluate and update all development impact fees to be consistent with the 2040 General Plan.

Additionally, the proposed General Plan policies related to encouraging infill development, such as Policy LU-2.2 ("Facilitate the development of at least 4,400 new housing units in the Greater Downtown by

## REVISIONS TO THE DRAFT EIR

2040") and its supporting actions, would make the provision of transit within Stockton more efficient with higher density development. Therefore, implementation of the proposed General Plan is not expected to worsen the gaps identified in the study, and will help further close remaining gaps.

Furthermore, wWith implementation of the proposed General Plan policies and actions, in combination with the proposed street network and land use patterns, the travel mode in Stockton is expected to shift to encourage more trips to occur via transit, bicycling and walking, as shown in Table 4.14-3.

Page 4.15-5 is amended as follows:

COSMUD pumps groundwater from the East San Joaquin Subbasin of the San Joaquin Valley Groundwater Basin. The City estimates the sustainable groundwater yield to be approximately 50,000 afy.<sup>10</sup>

COSMUD also obtains surface water from the San Joaquin Delta via the Delta Water Supply Project (DWSP) at the DWSP intake facility on the San Joaquin River west of the northern part of the EIR Study Area. The DWSP began drawing water from the San Joaquin River in 2012. The objective of this supply is to achieve a long-term reliable water supply from the Delta for existing and future customers. The City has rights to Delta water because portions of the City of Stockton Water Service Area fall within the legally defined Delta and the area of origin. The City's water rights application addressed a long-term planning horizon through the year 2050, requesting an ultimate diversion of 160 mgd, which is equivalent to 125,900 afy. The SWRCB divided the water rights application into two separate applications: Application 30531A and 30531B. Application 30531A covers the initial phase of the DWSP up to 30 mgd (33,600 afy) and the place of use is confined to the 1990 General Plan boundary. The initial phase was granted a water right under California Water Code (CWC) Section 1485. The City has a permit from the SWRCB issued on March 8, 2006 for a 33,600 afy supply from the Sacramento/San Joaquin Delta.

The DWSP intake and water treatment plant was operational in 2012 with an initial capacity of 30 mgd (33,600 afy). The projected capacity of the DWSP by 2035 is 90 mgd with an annual production of approximately 50,000 afy. The DWSP will expand as needed up to 120 mgd, provided water rights are granted.

The City's supply from the San Joaquin River is curtailed annually from February through June of each year due to US Department of Fish and Wildlife Service and California Department of Fish and Wildlife restrictions. CWC Section 1485, Water Rights, allows the City to take out of the Delta as much water as the City's wastewater treatment plant discharges into the Delta. This quantity, which fully covers the 33,600 afy, is not restricted as long as the same amount of wastewater is discharged into the Delta. CWC Section 1485 water may be subject to pumping restriction in some months due to fish protection.

The DWSP includes a water treatment plant with 30 mgd capacity. The DWSP is expected to be expanded to 90 mgd capacity by 2035, with annual production of about 44.6 mgd.<sup>40</sup>

---

<sup>10</sup> City of Stockton, 2016. 2015 Urban Water Management Plan.

Appendix C, Existing and Future Transportation Data Technical Memorandum, is revised as follows:



APPENDIX C:  
EXISTING AND FUTURE  
TRANSPORTATION DATA  
TECHNICAL MEMORANDUM





## FINAL MEMORANDUM

Date: September 6, 2018  
To: Tanya Sundberg, PlaceWorks  
From: Kathrin Tellez  
**Subject: Stockton General Plan – Existing and General Plan Transportation Data**

WC16-3309

---

The purpose of this memorandum is to compare base year transportation metrics to General Plan condition transportation metrics that will form the basis of the analysis for the Environmental Impact Report for the General Plan update as well as inform final policy direction. Data provided in this memorandum include:

- Base year morning and evening peak hour intersection turning movement volumes at 20-intersections
- Base year morning and evening peak hour intersection level of service results at 20-intersections
- Base year and General Plan daily roadway segment volumes for 166 locations throughout the General Plan planning area
- Base year and General Plan Person trips by mode of travel from the base year travel demand model
- Base year and General Plan Imported/exported person trips
- Base year and General Plan Vehicle miles of travel by speed

## INTERSECTION OPERATIONS

Weekday morning (7:00 to 9:00 AM) and evening (4:00 to 6:00 PM) peak period intersection turning movement counts were collected at 20 intersections throughout the City of Stockton, as shown on **Figure 1**, including separate counts of pedestrians, bicyclists, and heavy trucks. The study intersections were selected for a variety of reasons and include intersection that were documented in the Congestion Management Program (CMP) as operating at deficient levels, intersections on



major transit routes where poor intersection operations could degrade transit service, and intersections that serve as key gateways into the City.

All intersection data was collected on Thursday, June 1, 2017, a typical weekday with area schools in normal session. For the study intersections, the single hour with the highest traffic volumes during the count periods was identified. Peak hour intersection volumes are summarized on **Figure 2** along with the existing lane configuration and traffic control. The raw traffic counts for existing conditions are provided in **Appendix A**.

The operations of roadway facilities are typically described with the term “level of service” (LOS). LOS is a qualitative description of traffic flow from a vehicle driver’s perspective based on factors such as speed, travel time, delay, and freedom to maneuver. Six levels of service are defined ranging from LOS A (free flow operating conditions) to LOS F (congested operating conditions). LOS E corresponds to operations “at capacity.” When volumes exceed capacity, stop-and-go conditions result and operations are designated LOS F. In Stockton, the maximum level of acceptable delay is associated with LOS D (around 55 seconds of delay) with exceptions at select locations, including Downtown Stockton and adjacent to constrained freeway ramps where LOS E or F may be permitted.

Peak hour operations of the intersections was evaluated using methodologies proposed by the Transportation Research Board (TRB), as documented in the 2010 *Highway Capacity Manual* (2010 HCM) for vehicles. The HCM 2010 methods calculates control delay at an intersection based on inputs such as traffic volumes, lane geometry, signal phasing and timing, pedestrian crossing times, and peak hour factors. Control delay is defined as the delay directly associated with the traffic control device (i.e., a stop sign or a traffic signal) and specifically includes initial deceleration delay, queue move-up time, stopped delay, and final acceleration delay. These delay estimates are considered meaningful indicators of driver discomfort and frustration, fuel consumption, and lost travel time. The relationship between LOS and control delay is summarized in **Table 1**. While the level of service calculations do consider pedestrian, bicycle and transit vehicle travel through the intersection, the results are not indicative of the experience a pedestrian, bicyclist or transit rider might experience.

Existing operations were evaluated using the methods described above, as summarized in **Table 2**. The analysis was based on the volumes, lane configurations, and traffic control presented on



Figure 2. Observed peak hour factors<sup>1</sup> were used at all intersections for the existing analysis. Pedestrian and bicycle activity, as well as heavy trucks, were factored into the analysis. Detailed intersection LOS calculation worksheets are presented in **Appendix B**.

**TABLE 1**  
**SIGNALIZED INTERSECTION LOS CRITERIA**

| Level of Service | Description   | Delay in Seconds |
|------------------|---|------------------|
| A                | Progression is extremely favorable and most vehicles arrive during the green phase. Most vehicles do not stop at all. Short cycle lengths may also contribute to low delay.   | < 10.0           |
| B                | Progression is good, cycle lengths are short, or both. More vehicles stop than with LOS A, causing higher levels of average delay.  | > 10.0 to 20.0   |
| C                | Higher congestion may result from fair progression, longer cycle lengths, or both. Individual cycle failures may begin to appear at this level, though many still pass through the intersection without stopping.   | > 20.0 to 35.0   |
| D                | The influence of congestion becomes more noticeable. Longer delays may result from some combination of unfavorable progression, long cycle lengths, or high V/C ratios. Many vehicles stop, and the proportion of vehicles not stopping declines. Individual cycle failures are noticeable.                                     | > 35.0 to 55.0   |
| E                | This level is considered by many agencies to be the limit of acceptable delay. These high delay values generally indicate poor progression, long cycle lengths, and high V/C ratios. Individual cycle failures are frequent occurrences.  | > 55.0 to 80.0   |
| F                | This level is considered unacceptable with oversaturation, which is when arrival flow rates exceed the capacity of the intersection. This level may also occur at high V/C ratios below 1.0 with many individual cycle failures. Poor progression and long cycle lengths may also be contributing factors to such delay levels. | > 80.0           |

Source: 2010 *Highway Capacity Manual*.

<sup>1</sup> The peak hour factor is the relationship between the peak 15-minute flow rate and the full hourly volume:  $PHF = \text{Hourly volume} / (4 \times (\text{volume during the peak 15 minutes of flow}))$ . The analysis level of served is based on peak rates of flow occurring within the peak hour because substantial short term fluctuations typically occurring during an hour.



**TABLE 2**  
**EXISTING CONDITIONS – PEAK HOUR INTERSECTION LOS**

|    | Intersection  | Control    | Peak Hour | Existing Conditions |               |
|----|---|------------|-----------|---------------------|---------------|
|    |   |            |           | Delay               | LOS           |
| 1  | Trinity Parkway & Eight Mile Road                                   | Signalized | AM<br>PM  | 19.0<br>54.5        | B<br>D        |
| 2  | West Lane & Eight Mile Road   | Signalized | AM<br>PM  | 54.2<br><b>60.9</b> | D<br><b>E</b> |
| 3  | West Lane & Hammer Lane   | Signalized | AM<br>PM  | 46.9<br><b>63.2</b> | D<br><b>E</b> |
| 4  | Holman Road & Hammer Lane   | Signalized | AM<br>PM  | 33.8<br><b>63.5</b> | C<br><b>E</b> |
| 5  | Pacific Avenue/Thornton Road & Rivara Road/Lower Sacramento Road    | Signalized | AM<br>PM  | 38.4<br>40.6        | D<br>D        |
| 6  | Feather River Drive & March Lane                                    | Signalized | AM<br>PM  | <b>85.8</b><br>54.4 | <b>F</b><br>D |
| 7  | Pacific Avenue & March Lane   | Signalized | AM<br>PM  | 36.0<br><b>68.4</b> | D<br><b>E</b> |
| 8  | Pershing Avenue & County Club Boulevard                             | Signalized | AM<br>PM  | 21.8<br>24.3        | C<br>C        |
| 9  | El Dorado Street & Alpine Avenue                                    | Signalized | AM<br>PM  | 41.1<br>48.9        | D<br>D        |
| 10 | Pacific Avenue & Harding Way  | Signalized | AM<br>PM  | 21.8<br>25.1        | C<br>C        |
| 11 | Airport Way/West Lane & Harding Way                                 | Signalized | AM<br>PM  | 42.9<br>41.4        | D<br>D        |
| 12 | Fresno Avenue & Charter Way   | Signalized | AM<br>PM  | 42.9<br>35.9        | D<br>D        |
| 13 | Airport Way & Dr. Martin Luther King Jr. Boulevard                  | Signalized | AM<br>PM  | 26.7<br>34.2        | C<br>C        |
| 14 | Mariposa Road/Diamond Street & Dr. Martin Luther King Jr. Boulevard | Signalized | AM<br>PM  | 17.8<br>22.2        | B<br>C        |
| 15 | Mariposa Road & Stagecoach Road                                     | Signalized | AM<br>PM  | 8.9<br>8.4          | A<br>A        |



**TABLE 2**  
**EXISTING CONDITIONS – PEAK HOUR INTERSECTION LOS**

|    | Intersection                                   | Control    | Peak Hour | Existing Conditions |     |
|----|--|------------|-----------|---------------------|-----|
|    |  |            |           | Delay               | LOS |
| 16 | McDougald Boulevard & Carolyn Weston Boulevard | Signalized | AM        | 10.1                | B   |
|    |  |            | PM        | 10.9                | B   |
| 17 | Airport Way & Ralph Avenue                     | Signalized | AM        | 10.6                | B   |
|    |  |            | PM        | 17.8                | B   |
| 18 | Airport Way & Sperry Road/Arch Airport Road    | Signalized | AM        | 32.9                | C   |
|    |  |            | PM        | 42.8                | C   |
| 19 | Newcastle Road & Arch Road                     | Signalized | AM        | 7.8                 | A   |
|    |  |            | PM        | 12.7                | A   |
| 20 | Airport Way & French Camp Road                 | Signalized | AM        | 26.2                | C   |
|    |  |            | PM        | 35.5                | D   |

Notes:

1. Analysis results present delay (seconds per vehicle) and LOS (level of service). LOS is based on delay thresholds published in the Highway Capacity Manual (Transportation Research Board, 2010).
2. **Bold text** indicates potentially deficient intersection operations.

Source: Fehr & Peers, July 2017.

## ROADWAY SEGMENT OPERATIONS

The analysis of the daily roadway segment operations of the city's streets and highways was conducted using the method outlined in the 2035 General Plan Environmental Impact Report with the LOS thresholds used in this analysis provided in **Table 3**. Thresholds for arterials and collectors were based on Highway Capacity Manual calculations and were developed in conjunction with City staff at the time the current General Plan analysis was prepared. The arterial thresholds distinguish between roads in the existing urbanized area and those in new development areas; because arterials in new development areas can be designed to higher standards, with medians, exclusive turn lanes, and controlled access from adjacent uses, the capacities are higher than those in previously-developed areas. Thresholds for freeways were based on Highway Capacity Manual procedures relating levels of service to vehicle density ranges.



**TABLE 3**  
**ROADWAY SEGMENT LEVEL OF SERVICE THRESHOLDS (BI-DIRECTIONAL)**

| Facility Class | Lanes | Area Type | LOS A  | LOS B   | LOS C   | LOS D   | LOS E   |
|----------------|-------|-----------|--------|---------|---------|---------|---------|
| Freeway        | 4     | All Areas | 27,600 | 45,200  | 63,600  | 77,400  | 86,400  |
|                | 6     | All Areas | 41,400 | 67,800  | 95,400  | 116,100 | 129,600 |
|                | 8     | All Areas | 55,200 | 90,400  | 127,200 | 154,800 | 172,800 |
|                | 10    | All Areas | 69,000 | 113,000 | 159,000 | 193,500 | 216,000 |
| Arterial       | 2     | Existing  | 8,400  | 9,300   | 11,800  | 14,700  | 17,300  |
|                | 2     | New       | 10,000 | 11,100  | 14,000  | 17,500  | 20,600  |
|                | 4     | Existing  | 18,600 | 20,600  | 26,000  | 32,500  | 38,200  |
|                | 4     | New       | 23,300 | 25,800  | 32,600  | 40,700  | 47,900  |
|                | 6     | Existing  | 28,800 | 32,000  | 40,300  | 50,400  | 59,300  |
|                | 6     | New       | 33,300 | 37,000  | 46,600  | 58,300  | 68,600  |
|                | 8     | Existing  | 38,100 | 42,300  | 53,300  | 66,600  | 78,400  |
|                | 8     | New       | 41,100 | 45,700  | 57,600  | 72,000  | 84,700  |
| Collector      | 2     | Existing  | 6,400  | 7,100   | 9,000   | 11,300  | 13,200  |
|                | 2     | New       | 6,400  | 7,100   | 9,000   | 11,300  | 13,200  |
|                | 4     | Existing  | 17,600 | 19,600  | 24,700  | 30,900  | 36,300  |
|                | 4     | New       | 21,100 | 23,500  | 29,600  | 37,000  | 43,500  |

The "Existing" Area is generally located between I-5 and SR 99, and between Eight Mile Road and French Camp Road.

Note: Eight Mile Road is considered a "New" arterial due to lack of existing development in the area.

Source: *Highway Capacity Manual*, Transportation Research Board, 2000; Fehr & Peers, 2005.

Daily operations of roadway segments were evaluated by comparing the traffic volume on a roadway facility to the functional capacity of the roadway for 166 roadway segments within the Planning Area. Existing count data was collected from a variety of sources, including Caltrans, the City of Stockton, and 48-hour roadway counts collected by Fehr & Peers in 2016. The existing conditions data presented below was used as the basis for validating the base year travel forecasting model. Some data was not collected in the model base year of 2016 and adjustments were made to approximate 2016 conditions, which including the application of a growth rate based





on data collected in the similar area at multiple time periods. Forecasted General Plan conditions were developed using the City of Stockton General Plan model. The process which was undertaken to develop the model is detailed in a separate memorandum. To account for model error, the difference between the base year model forecast and General Plan model forecast was added to the existing traffic count for the analysis segments.

Based on the General Plan model (model development details provided as part of a separate memorandum), preliminary General Plan daily roadway segment volumes were forecast based on the General Plan land use map, and the current General Plan circulation element with some preliminary modifications, including:

- No roadway improvements north of Eight Mile Road
- State Route 99 is improved to provide 4 travel lanes per direction (as opposed to the 5-lanes per direction between Farmington Road and Gateway Boulevard in the current General Plan)
- No extension of Trinity Parkway south of Hammer Lane

Preliminary analysis results indicated that there were opportunities to reduce the planned cross sections of a number of roadways. An iterative process was undertaken to identify the roadway network that was used as the basis of analysis, with details presented in **Table 4**. Based on the final roadway network, daily roadway segment forecasts with the proposed General Plan were developed, as shown in **Table 5**.



**TABLE 4  
 TRANSPORTATION NETWORK ASSUMPTIONS**

| Travel Mode | Initial Working Draft Preferred GP  | Refinement 1   | Refinement 2  |
|-------------|---|--|---|
| Roadways    | <p>Pivot from 2035 GP; eliminates roadway improvements north of Eight Mile Road, extension of Trinity Parkway south of Sanctuary Development, Expressway System north of Main Street; assumes widening of SR 99 to eight lanes (as opposed to 10)</p> | <p>All upgraded surface streets capped at a six lane cross-section:<br/>           Eight Mile Road<br/>           Hammer Lane<br/>           March Lane<br/>           French Camp Road<br/>           Sperry Road/Arch Road<br/>           Mathews Road<br/>           West Lane<br/>           Airport Way</p> <p>Other modifications include:<br/>           Eighth Street: I-5 to El Dorado, maintain existing 4 lanes (instead of planned 6 lanes), no connection over railroad tracks, no Otto Drive interchange</p> | <p>Further lane reductions including:<br/>           French Camp Road from Wolfe Road to SR 99 – reduce to 4 lanes<br/>           Mathews Road/Howard Road from El Dorado Street to Wolfe Road –no improvements from existing<br/>           Sperry Road – from French Camp to Airport Way, reduce to 4 lanes<br/>           Airport Way from Arch/Airport to French Camp – reduce to 4 lanes<br/>           El Dorado from 4th Street to French Camp Road – reduce to 4 lanes<br/>           Arch Road from Frontier to Newcastle – reduce to 4 lanes<br/>           Mariposa Road from Austin to Carpenter – reduce to 4 lanes<br/>           Hammer Lane from Lower Sacramento to Maranatha Drive – reduce to 6 lanes<br/>           Holman Road – from March Lane to Eight Mile Road, reduce to 4 lanes<br/>           Morada Lane from West lane to SR 99, reduce to 4 lanes<br/>           Lower Sacramento from Hammer Lane to Eight Mile Road, reduce to 4 lanes<br/>           Thornton Road from Hammer Lane to Eight Mile Road, reduce to 4 lanes<br/>           Eight Mile Road, west of Trinity Parkway, reduce to 4 lanes<br/>           Eight Mile Road from Thornton Road to West Lane, reduce to 4 lanes<br/>           Wilson Way from Charter Way to SR 99, reduce to 4 lanes<br/>           March Lane – reduce existing 8-lane cross section to 6-lanes<br/>           Eighth Street: Provide two lane connection over railroad.</p> |



**TABLE 4**  
**TRANSPORTATION NETWORK ASSUMPTIONS**

| Travel Mode | Initial Working Draft Preferred GP | Refinement 1  | Refinement 2                 |
|-------------|------------------------------------|---|------------------------------|
| Bicycle     | No Changes from Existing           | Adds off-street bicycle network identified in BMP; assumes lane reductions to provide bicycle facilities:<br>California Street: Alpine to Oak reduce from 4 lane to 2 lane<br>Alpine Avenue: Ryde Avenue to California Street reduce from 4 lane to 2 lane            | No change from refinement 1. |
| Transit     | No Changes from Existing           | Add BRT Routes from S RTP with stops at major intersections and 10 minute headways during core service hours (matching existing BRT routes) :<br>Eight Mile Road<br>West Lane<br>Pacific Corridor<br>Airport Corridor<br>March Lane<br>Downtown<br>MLK<br>Arch/Sperry | No change from refinement 2. |

---

Source: Fehr & Peers in consultation with City of Stockton Staff.





**TABLE 5**  
**STOCKTON GENERAL PLAN - ROADWAY OPERATIONS**

| Segment ID | Roadway | Between                  |                        | Base Year        |                    |                |     | 2040 Plus Project |                    |                |     | Change: Base to Future |       |
|------------|---------|--------------------------|------------------------|------------------|--------------------|----------------|-----|-------------------|--------------------|----------------|-----|------------------------|-------|
|            |         |                          |                        | ADT <sup>1</sup> | Lanes <sup>2</sup> | Classification | LOS | ADT <sup>1</sup>  | Lanes <sup>2</sup> | Classification | LOS | ADT                    | Lanes |
| 1          | I-5     | North of Eight Mile Road |                        | 65,000           | 6                  | Freeway        | B   | 87,700            | 8                  | Freeway        | B   | 22,700                 | 2     |
| 2          | I-5     | Eight Mile Road          | Hammer Lane            | 78,000           | 6                  | Freeway        | C   | 106,200           | 10                 | Freeway        | B   | 28,200                 | 4     |
| 3          | I-5     | Hammer Lane              | Ben Holt Drive         | 106,000          | 8                  | Freeway        | C   | 148,000           | 10                 | Freeway        | C   | 42,000                 | 2     |
| 4          | I-5     | Ben Holt Drive           | March Lane             | 120,000          | 8                  | Freeway        | C   | 163,700           | 10                 | Freeway        | D   | 43,700                 | 2     |
| 5          | I-5     | March Lane               | Country Club Boulevard | 121,000          | 8                  | Freeway        | C   | 174,800           | 10                 | Freeway        | D   | 53,800                 | 2     |
| 6          | I-5     | Country Club Boulevard   | Monte Diablo Avenue    | 134,730          | 8                  | Freeway        | D   | 189,800           | 10                 | Freeway        | D   | 55,070                 | 2     |
| 7          | I-5     | Monte Diablo Avenue      | Pershing Avenue        | 137,170          | 8                  | Freeway        | D   | 190,100           | 10                 | Freeway        | D   | 52,930                 | 2     |
| 8          | I-5     | Pershing Avenue          | Crosstown Freeway      | 108,580          | 8                  | Freeway        | C   | 164,100           | 10                 | Freeway        | D   | 55,520                 | 2     |
| 9          | I-5     | Crosstown Freeway        | Charter Way            | 143,310          | 8                  | Freeway        | D   | 199,800           | 10                 | Freeway        | E   | 56,490                 | 2     |
| 10         | I-5     | Charter Way              | 8th Street             | 151,800          | 6                  | Freeway        | F   | 223,000           | 10                 | Freeway        | F   | 71,200                 | 4     |
| 11         | I-5     | 8th Street               | Downing Avenue         | 113,640          | 6                  | Freeway        | D   | 178,200           | 8                  | Freeway        | F   | 64,560                 | 2     |
| 12         | I-5     | Downing Avenue           | French Camp Road       | 120,000          | 6                  | Freeway        | E   | 145,600           | 8                  | Freeway        | D   | 25,600                 | 2     |
| 13         | I-5     | French Camp Road         | Mathews Road           | 115,500          | 6                  | Freeway        | D   | 142,100           | 8                  | Freeway        | D   | 26,600                 | 2     |
| 14         | SR 99   | North of Eight Mile Road | 0                      | 85,910           | 6                  | Freeway        | C   | 116,300           | 8                  | Freeway        | C   | 30,390                 | 2     |
| 15         | SR 99   | Eight Mile Road          | Morada Lane            | 81,000           | 6                  | Freeway        | C   | 124,900           | 8                  | Freeway        | C   | 43,900                 | 2     |
| 16         | SR 99   | Morada Lane              | Hammer Lane            | 86,000           | 6                  | Freeway        | C   | 146,800           | 8                  | Freeway        | D   | 60,800                 | 2     |
| 17         | SR 99   | Hammer Lane              | Wilson Way             | 105,000          | 6                  | Freeway        | D   | 174,300           | 8                  | Freeway        | F   | 69,300                 | 2     |
| 18         | SR 99   | Wilson Way               | Cherokee Road          | 98,120           | 6                  | Freeway        | D   | 167,400           | 8                  | Freeway        | E   | 69,280                 | 2     |
| 19         | SR 99   | Cherokee Road            | Waterloo Road          | 107,260          | 6                  | Freeway        | D   | 213,700           | 8                  | Freeway        | F   | 106,440                | 2     |
| 20         | SR 99   | Waterloo Road            | Fremont Street         | 115,390          | 6                  | Freeway        | D   | 222,600           | 8                  | Freeway        | F   | 107,210                | 2     |
| 21         | SR 99   | Fremont Street           | Crosstown Freeway      | 114,000          | 6                  | Freeway        | D   | 220,700           | 8                  | Freeway        | F   | 106,700                | 2     |



**TABLE 5**  
**STOCKTON GENERAL PLAN - ROADWAY OPERATIONS**

| Segment ID | Roadway       | Between                    |                            | Base Year        |                    |                |     | 2040 Plus Project |                    |                |     | Change: Base to Future |       |
|------------|---------------|----------------------------|----------------------------|------------------|--------------------|----------------|-----|-------------------|--------------------|----------------|-----|------------------------|-------|
|            |               |                            |                            | ADT <sup>1</sup> | Lanes <sup>2</sup> | Classification | LOS | ADT <sup>1</sup>  | Lanes <sup>2</sup> | Classification | LOS | ADT                    | Lanes |
| 22         | SR 99         | Crosstown Freeway          | Martin Luther King Jr Blvd | 103,400          | 6                  | Freeway        | D   | 192,300           | 8                  | Freeway        | F   | 88,900                 | 2     |
| 23         | SR 99         | Martin Luther King Jr Blvd | Farmington Rd              | 95,700           | 6                  | Freeway        | D   | 184,600           | 8                  | Freeway        | F   | 88,900                 | 2     |
| 24         | SR 99         | Farmington Rd              | Mariposa Rd                | 80,300           | 6                  | Freeway        | C   | 169,200           | 8                  | Freeway        | E   | 88,900                 | 2     |
| 25         | SR 99         | Mariposa Road              | Arch Road                  | 78,000           | 6                  | Freeway        | C   | 127,800           | 8                  | Freeway        | D   | 49,800                 | 2     |
| 26         | SR 99         | Arch Road                  | French Camp Road           | 74,000           | 6                  | Freeway        | C   | 89,200            | 8                  | Freeway        | B   | 15,200                 | 2     |
| 27         | SR 99         | French Camp Road           | Lathrop Road               | 74,000           | 6                  | Freeway        | C   | 92,800            | 8                  | Freeway        | C   | 18,800                 | 2     |
| 28         | SR 4          | West of I-5                | West of I-5                | 18,150           | 4                  | Freeway        | A   | 39,400            | 4                  | Freeway        | B   | 21,250                 | 0     |
| 29         | SR 4          | I-5                        | El Dorado St               | 85,000           | 8                  | Freeway        | B   | 114,900           | 8                  | Freeway        | C   | 29,900                 | 0     |
| 30         | SR 4          | El Dorado Street           | Stanislaus Street          | 115,140          | 8                  | Freeway        | C   | 152,100           | 8                  | Freeway        | D   | 36,960                 | 0     |
| 31         | SR 4          | Stanislaus Street          | Wilson Way                 | 105,000          | 6                  | Freeway        | D   | 143,000           | 8                  | Freeway        | D   | 38,000                 | 2     |
| 32         | Eight Mile Rd | Mokelumne Drive            | Trinity Parkway            | 9,010            | 2                  | Arterial       | B   | 24,200            | 4                  | Arterial       | B   | 15,190                 | 2     |
| 33         | Eight Mile Rd | Trinity Parkway            | I-5                        | 31,480           | 8                  | Arterial       | A   | 31,600            | 8                  | Arterial       | A   | 120                    | 0     |
| 34         | Eight Mile Rd | Thornton Rd                | Davis Rd                   | 15,460           | 4                  | Arterial       | A   | 21,900            | 4                  | Arterial       | A   | 6,440                  | 0     |
| 35         | Eight Mile Rd | Davis Rd                   | Lower Sacramento           | 16,930           | 2                  | Arterial       | E   | 26,600            | 4                  | Arterial       | C   | 9,670                  | 2     |
| 36         | Eight Mile Rd | Lower Sacramento           | West Lane                  | 20,420           | 2                  | Arterial       | F   | 36,500            | 4                  | Arterial       | D   | 16,080                 | 2     |
| 37         | Eight Mile Rd | West Lane                  | SPRR                       | 13,170           | 2                  | Arterial       | D   | 29,500            | 6                  | Arterial       | A   | 16,330                 | 4     |
| 38         | Eight Mile Rd | West of Bear Creek         | Rt 99                      | 11,810           | 2                  | Arterial       | D   | 29,900            | 6                  | Arterial       | A   | 18,090                 | 4     |
| 39         | Morada Lane   | Lower Sacramento Rd        | West Lane                  | 0                | 0                  | Arterial       | A   | 8,600             | 4                  | Arterial       | A   | 8,600                  | 4     |
| 40         | Morada Lane   | Cherbourg                  | West                       | 14,290           | 4                  | Arterial       | A   | 18,500            | 4                  | Arterial       | A   | 4,210                  | 0     |
| 41         | Morada Lane   | Cherbourg                  | Fox Creek                  | 15,430           | 4                  | Arterial       | A   | 18,300            | 4                  | Arterial       | A   | 2,870                  | 0     |
| 42         | Morada Lane   | Holman                     | Hwy 99                     | 18,010           | 6                  | Arterial       | A   | 18,900            | 4                  | Arterial       | A   | 890                    | -2    |



**TABLE 5  
STOCKTON GENERAL PLAN - ROADWAY OPERATIONS**

| Segment ID | Roadway             | Between             |                 | Base Year        |                    |                |     | 2040 Plus Project |                    |                |     | Change: Base to Future |       |
|------------|---------------------|---------------------|-----------------|------------------|--------------------|----------------|-----|-------------------|--------------------|----------------|-----|------------------------|-------|
|            |                     |                     |                 | ADT <sup>1</sup> | Lanes <sup>2</sup> | Classification | LOS | ADT <sup>1</sup>  | Lanes <sup>2</sup> | Classification | LOS | ADT                    | Lanes |
| 43         | Morada Lane         | Mosher Creek        | Holman          | 16,160           | 6                  | Collector      | A   | 17,900            | 4                  | Collector      | A   | 1,740                  | -2    |
| 44         | Hammer Lane         | Mariners Dr         | I-5             | 17,010           | 6                  | Arterial       | A   | 23,200            | 6                  | Arterial       | A   | 6,190                  | 0     |
| 45         | Hammer Lane         | Westland            | Richland        | 31,960           | 6                  | Arterial       | B   | 35,300            | 6                  | Arterial       | B   | 3,340                  | 0     |
| 46         | Hammer Lane         | Pershing Ave        | Valencia        | 28,610           | 4                  | Arterial       | D   | 29,600            | 6                  | Arterial       | A   | 990                    | 2     |
| 47         | Hammer Lane         | Lower Sacramento Rd | El Dorado St    | 41,780           | 8                  | Arterial       | B   | 31,300            | 6                  | Arterial       | A   | -10,480                | -2    |
| 48         | Hammer Lane         | At WPRR             | 0               | 48,730           | 8                  | Arterial       | C   | 31,600            | 6                  | Arterial       | A   | -17,130                | -2    |
| 49         | Hammer Lane         | SPRR                | Holman Rd       | 42,060           | 8                  | Arterial       | B   | 29,200            | 6                  | Arterial       | A   | -12,860                | -2    |
| 50         | Hammer Lane         | Holman Rd           | Rt 99           | 40,360           | 8                  | Arterial       | B   | 32,500            | 6                  | Arterial       | A   | -7,860                 | -2    |
| 51         | Benjamin Holt Drive | Plymouth            | Belmont         | 22,630           | 2                  | Arterial       | F   | 21,500            | 2                  | Arterial       | F   | -1,130                 | 0     |
| 52         | Benjamin Holt Drive | Vicksburg           | Gettysburg      | 16,380           | 2                  | Arterial       | E   | 15,200            | 2                  | Arterial       | D   | -1,180                 | 0     |
| 53         | Swain Rd            | Pylmouth Road       | Morgan          | 10,690           | 2                  | Local          | A   | 10,700            | 2                  | Local          | A   | 10                     | 0     |
| 54         | Swain Rd            | Pershing Avenue     | Vicksburg Place | 9,670            | 2                  | Local          | A   | 9,500             | 2                  | Local          | A   | -170                   | 0     |
| 55         | March Lane          | Brookside Rd        | Morningside Dr  | 6,950            | 6                  | Arterial       | A   | 8,800             | 6                  | Arterial       | A   | 1,850                  | 0     |
| 56         | March Lane          | Feather River Drive | I-5             | 40,100           | 6                  | Arterial       | C   | 43,800            | 6                  | Arterial       | C   | 3,700                  | 0     |
| 57         | March Lane          | Quail Lakes         | Grouse Run      | 43,050           | 6                  | Arterial       | D   | 42,400            | 6                  | Arterial       | C   | -650                   | 0     |
| 58         | March Lane          | Pershing Ave        | Pacific Ave     | 42,910           | 6                  | Arterial       | D   | 41,100            | 6                  | Arterial       | C   | -1,810                 | 0     |
| 59         | March Lane          | Pacific Ave         | Claremont       | 33,060           | 6                  | Arterial       | C   | 41,100            | 6                  | Arterial       | C   | 8,040                  | 0     |
| 60         | March Lane          | At UPRR             | 0               | 38,800           | 6                  | Arterial       | C   | 58,300            | 6                  | Arterial       | E   | 19,500                 | 0     |
| 61         | March Lane          | West Lane           | Bianchi         | 28,720           | 8                  | Arterial       | A   | 72,700            | 6                  | Arterial       | F   | 43,980                 | -2    |
| 62         | Alpine Avenue       | Pershing            | Grange          | 9,140            | 4                  | Local          | A   | 8,900             | 2                  | Local          | A   | -240                   | -2    |



**TABLE 5  
STOCKTON GENERAL PLAN - ROADWAY OPERATIONS**

| Segment ID | Roadway             | Between          |                 | Base Year        |                    |                |     | 2040 Plus Project |                    |                |     | Change: Base to Future |       |
|------------|---------------------|------------------|-----------------|------------------|--------------------|----------------|-----|-------------------|--------------------|----------------|-----|------------------------|-------|
|            |                     |                  |                 | ADT <sup>1</sup> | Lanes <sup>2</sup> | Classification | LOS | ADT <sup>1</sup>  | Lanes <sup>2</sup> | Classification | LOS | ADT                    | Lanes |
| 63         | Alpine Avenue       | Dwight           | Kensington      | 7,820            | 4                  | Local          | A   | 7,800             | 2                  | Local          | A   | -20                    | -2    |
| 64         | Alpine Avenue       | Center           | Commerce        | 14,490           | 4                  | Arterial       | A   | 8,600             | 2                  | Arterial       | A   | -5,890                 | -2    |
| 65         | Alpine Avenue       | Sutter           | San Joaquin     | 20,460           | 4                  | Arterial       | B   | 11,800            | 2                  | Arterial       | C   | -8,660                 | -2    |
| 66         | Country Club Drive  | Grange Avenue    | Pershing Avenue | 8,910            | 2                  | Arterial       | B   | 8,700             | 2                  | Arterial       | A   | -210                   | 0     |
| 67         | Monte Diablo Avenue | San Juan         | Buena Vista     | 3,540            | 2                  | Arterial       | A   | 3,700             | 2                  | Arterial       | A   | 160                    | 0     |
| 68         | Harding Way         | Pershing         | Columbia        | 3,810            | 2                  | Arterial       | A   | 3,600             | 2                  | Arterial       | A   | -210                   | 0     |
| 69         | Harding Way         | Baker            | Stockton        | 11,330           | 2                  | Arterial       | C   | 11,400            | 2                  | Arterial       | C   | 70                     | 0     |
| 70         | Harding Way         | Commerce         | Madison         | 24,300           | 4                  | Arterial       | C   | 23,300            | 4                  | Arterial       | B   | -1,000                 | 0     |
| 71         | Harding Way         | El Dorado        | Center          | 25,910           | 4                  | Arterial       | C   | 27,300            | 4                  | Arterial       | C   | 1,390                  | 0     |
| 72         | Harding Way         | California       | San Joaquin     | 21,470           | 4                  | Arterial       | C   | 27,800            | 4                  | Arterial       | C   | 6,330                  | 0     |
| 73         | Harding Way         | At UPRR          | 0               | 19,550           | 4                  | Arterial       | B   | 18,300            | 4                  | Arterial       | A   | -1,250                 | 0     |
| 74         | Harding Way         | Wilson           | Sierra Nevada   | 22,040           | 4                  | Arterial       | C   | 16,600            | 4                  | Arterial       | A   | -5,440                 | 0     |
| 75         | Fremont St          | Watts            | Laurel          | 14,610           | 2                  | Arterial       | D   | 11,200            | 4                  | Arterial       | A   | -3,410                 | 2     |
| 76         | Fremont St          | Broadway         | Golden Gate     | 10,960           | 2                  | Arterial       | C   | 14,900            | 4                  | Arterial       | A   | 3,940                  | 2     |
| 77         | Miner Ave           | El Dorado Street | Center Street   | 7,160            | 4                  | Arterial       | A   | 12,500            | 4                  | Arterial       | A   | 5,340                  | 0     |
| 78         | Miner Ave           | California       | San Joaquin     | 8,770            | 4                  | Arterial       | A   | 11,300            | 4                  | Arterial       | A   | 2,530                  | 0     |
| 79         | Main St             | California       | Sutter          | 3,210            | 2                  | Arterial       | A   | 3,700             | 2                  | Arterial       | A   | 490                    | 0     |
| 80         | Main St             | Court            | Ash             | 9,890            | 4                  | Arterial       | A   | 14,500            | 4                  | Arterial       | A   | 4,610                  | 0     |
| 81         | Main St             | Netherton        | Golden Gate     | 15,020           | 4                  | Arterial       | A   | 24,000            | 4                  | Arterial       | B   | 8,980                  | 0     |





**TABLE 5  
STOCKTON GENERAL PLAN - ROADWAY OPERATIONS**

| Segment ID | Roadway                     | Between            |                    | Base Year        |                    |                |     | 2040 Plus Project |                    |                |     | Change: Base to Future |       |
|------------|-----------------------------|--------------------|--------------------|------------------|--------------------|----------------|-----|-------------------|--------------------|----------------|-----|------------------------|-------|
|            |                             |                    |                    | ADT <sup>1</sup> | Lanes <sup>2</sup> | Classification | LOS | ADT <sup>1</sup>  | Lanes <sup>2</sup> | Classification | LOS | ADT                    | Lanes |
| 82         | Charter Way                 | W of Roberts       | W of Roberts       | 13,650           | 2                  | Expressway     | A   | 17,500            | 4                  | Expressway     | A   | 3,850                  | 2     |
| 83         | Charter Way                 | Tillie Lewis Drive | Fresno Avenue      | 12,480           | 2                  | Arterial       | D   | 5,230             | 2                  | Arterial       | A   | -7,250                 | 0     |
| 84         | Charter Way                 | Navy               | Fresno             | 17,420           | 2                  | Arterial       | F   | 7,420             | 2                  | Arterial       | A   | -10,000                | 0     |
| 85         | Charter Way                 | I-5                | Navy               | 31,980           | 2                  | Arterial       | F   | 18,300            | 2                  | Arterial       | E   | -13,680                | 0     |
| 86         | Martin Luther King Jr. Blvd | I-5                | Lincoln            | 34,420           | 4                  | Arterial       | E   | 48,800            | 4                  | Arterial       | F   | 14,380                 | 0     |
| 87         | Martin Luther King Jr. Blvd | California         | Airport Way        | 30,000           | 4                  | Arterial       | D   | 42,400            | 4                  | Arterial       | E   | 12,400                 | 0     |
| 88         | Martin Luther King Jr. Blvd | Airport Way        | Wilson Way         | 28,550           | 4                  | Arterial       | D   | 43,100            | 6                  | Arterial       | C   | 14,550                 | 2     |
| 89         | Martin Luther King Jr. Blvd | Mariposa Road      | Golden Gate Avenue | 15,220           | 2                  | Arterial       | E   | 17,300            | 4                  | Arterial       | A   | 2,080                  | 2     |
| 90         | Navy Dr                     | San Joaquin River  | Washington         | 4,560            | 2                  | Arterial       | A   | 4,600             | 2                  | Arterial       | A   | 40                     | 0     |
| 91         | Navy Dr                     | BN&SF RR           | Tillie Lewis       | 5,090            | 2                  | Arterial       | A   | 5,700             | 4                  | Arterial       | A   | 610                    | 2     |
| 92         | Navy Dr                     | Josephine          | Fresno             | 3,970            | 2                  | Arterial       | A   | 5,000             | 2                  | Arterial       | A   | 1,030                  | 0     |
| 93         | Washington St               | Agribusiness       | Ventura            | 7,940            | 2                  | Collector      | C   | 7,300             | 2                  | Collector      | C   | -640                   | 0     |
| 94         | 8th Street                  | Argonaut           | Fresno             | 12,030           | 4                  | Collector      | A   | 10,500            | 4                  | Collector      | A   | -1,530                 | 0     |
| 95         | 8th Street                  | Monroe             | Lincoln            | 7,890            | 4                  | Local          | A   | 13,000            | 4                  | Local          | A   | 5,110                  | 0     |
| 96         | 8th Street                  | Pock               | D                  | 8,190            | 2                  | Collector      | C   | 12,500            | 2                  | Collector      | E   | 4,310                  | 0     |
| 97         | Carolyn Weston Boulevard    | Manthey            | McDougald          | 27,660           | 4                  | Arterial       | D   | 29,700            | 4                  | Arterial       | C   | 2,040                  | 0     |
| 98         | French Camp Rd              | McDougald          | E.W.S.Wood         | 10,280           | 2                  | Arterial       | C   | 30,300            | 4                  | Arterial       | C   | 20,020                 | 2     |
| 99         | Sperry Road                 | Airport            | McKinley           | 10,560           | 4                  | Arterial       | A   | 30,700            | 4                  | Arterial       | C   | 20,140                 | 0     |



**TABLE 5  
 STOCKTON GENERAL PLAN - ROADWAY OPERATIONS**

| Segment ID | Roadway          | Between             |                | Base Year        |                    |                |     | 2040 Plus Project |                    |                |     | Change: Base to Future |       |
|------------|------------------|---------------------|----------------|------------------|--------------------|----------------|-----|-------------------|--------------------|----------------|-----|------------------------|-------|
|            |                  |                     |                | ADT <sup>1</sup> | Lanes <sup>2</sup> | Classification | LOS | ADT <sup>1</sup>  | Lanes <sup>2</sup> | Classification | LOS | ADT                    | Lanes |
| 100        | Arch-Airport Rd  | Airport             | Pock           | 16,680           | 2                  | Arterial       | E   | 41,200            | 6                  | Arterial       | C   | 24,520                 | 4     |
| 101        | Arch-Airport Rd  | HW 99               | Quantas        | 27,070           | 4                  | Arterial       | D   | 61,700            | 6                  | Arterial       | E   | 34,630                 | 2     |
| 102        | Arch Rd          | Frontier            | HW 99 Frontage | 14,010           | 2                  | Arterial       | D   | 39,600            | 6                  | Arterial       | C   | 25,590                 | 4     |
| 103        | Arch Rd          | Newcastle           | Frontier       | 12,340           | 2                  | Arterial       | D   | 36,900            | 4                  | Arterial       | D   | 24,560                 | 2     |
| 104        | Trinity Parkway  | Scott Creek         | 8 Mile         | 14,260           | 6                  | Arterial       | A   | 15,700            | 6                  | Arterial       | A   | 1,440                  | 0     |
| 105        | Trinity Parkway  | Cosumnes            | McAuliffe      | 8,030            | 6                  | Arterial       | A   | 7,700             | 6                  | Arterial       | A   | -330                   | 0     |
| 106        | Thornton Rd      | Bear Creek          | Estate         | 21,140           | 4                  | Arterial       | C   | 19,900            | 4                  | Arterial       | A   | -1,240                 | 0     |
| 107        | Thornton Rd      | Waudman             | Davis          | 25,070           | 2                  | Arterial       | F   | 22,400            | 4                  | Arterial       | A   | -2,670                 | 2     |
| 108        | Thornton Rd      | Aberdeen            | Cortez         | 37,460           | 2                  | Arterial       | F   | 34,400            | 4                  | Arterial       | D   | -3,060                 | 2     |
| 109        | Thornton Rd      | Hammer              | Rivera         | 22,650           | 4                  | Arterial       | C   | 23,100            | 6                  | Arterial       | A   | 450                    | 2     |
| 110        | Davis Rd         | Chaparral           | Laramie        | 11,480           | 2                  | Arterial       | C   | 13,200            | 4                  | Arterial       | A   | 1,720                  | 2     |
| 111        | Davis Rd         | North of Bear Creek | 0              | 9,170            | 2                  | Arterial       | B   | 8,900             | 4                  | Arterial       | A   | -270                   | 2     |
| 112        | Davis Rd         | Ponce De Leon       | Thornton       | 15,400           | 2                  | Arterial       | E   | 17,500            | 4                  | Arterial       | A   | 2,100                  | 2     |
| 113        | Lower Sacramento | Armor               | Royal Oaks     | 17,620           | 4                  | Arterial       | A   | 24,100            | 4                  | Arterial       | B   | 6,480                  | 0     |
| 114        | Lower Sacramento | Bear Creek          | Eight Mile     | 16,340           | 2                  | Arterial       | E   | 22,300            | 4                  | Arterial       | A   | 5,960                  | 2     |
| 115        | Lower Sacramento | Hammer              | Rivera         | 17,610           | 4                  | Arterial       | A   | 17,200            | 4                  | Arterial       | A   | -410                   | 0     |
| 116        | West Lane        | 8 Mile              | Morada         | 17,180           | 4                  | Arterial       | A   | 23,100            | 6                  | Arterial       | A   | 5,920                  | 2     |
| 117        | West Lane        | Dalewood            | Westmora       | 25,010           | 6                  | Arterial       | A   | 30,700            | 6                  | Arterial       | A   | 5,690                  | 0     |
| 118        | West Lane        | Hammer              | Hammertown     | 31,760           | 8                  | Arterial       | A   | 25,900            | 6                  | Arterial       | A   | -5,860                 | -2    |



**TABLE 5  
 STOCKTON GENERAL PLAN - ROADWAY OPERATIONS**

| Segment ID | Roadway      | Between             |               | Base Year        |                    |                |     | 2040 Plus Project |                    |                |     | Change: Base to Future |       |
|------------|--------------|---------------------|---------------|------------------|--------------------|----------------|-----|-------------------|--------------------|----------------|-----|------------------------|-------|
|            |              |                     |               | ADT <sup>1</sup> | Lanes <sup>2</sup> | Classification | LOS | ADT <sup>1</sup>  | Lanes <sup>2</sup> | Classification | LOS | ADT                    | Lanes |
| 119        | West Lane    | Swain               | March         | 37,470           | 4                  | Arterial       | E   | 46,900            | 6                  | Arterial       | D   | 9,430                  | 2     |
| 120        | West Lane    | Bradford            | Walnut        | 24,320           | 4                  | Arterial       | C   | 31,100            | 6                  | Arterial       | A   | 6,780                  | 2     |
| 121        | Wilson Way   | McAllen             | Alpine        | 16,290           | 4                  | Arterial       | A   | 20,400            | 4                  | Arterial       | A   | 4,110                  | 0     |
| 122        | Wilson Way   | Main                | Market        | 26,040           | 4                  | Arterial       | D   | 29,800            | 4                  | Arterial       | C   | 3,760                  | 0     |
| 123        | Wilson Way   | Market              | Washington    | 26,340           | 4                  | Arterial       | D   | 30,700            | 4                  | Arterial       | C   | 4,360                  | 0     |
| 124        | Pershing Ave | Venetian            | Burke-Bradley | 24,740           | 4                  | Arterial       | C   | 26,000            | 4                  | Arterial       | C   | 1,260                  | 0     |
| 125        | Pershing Ave | At Calaveras River  | 0             | 35,990           | 4                  | Arterial       | E   | 32,600            | 4                  | Arterial       | D   | -3,390                 | 0     |
| 126        | Pershing Ave | Magnolia            | Acacia        | 20,440           | 4                  | Arterial       | B   | 21,200            | 4                  | Arterial       | A   | 760                    | 0     |
| 127        | Pacific Ave  | Douglas             | Porter        | 39,970           | 6                  | Arterial       | C   | 43,200            | 6                  | Arterial       | C   | 3,230                  | 0     |
| 128        | Pacific Ave  | Yokuts              | March         | 33,730           | 6                  | Arterial       | C   | 39,000            | 6                  | Arterial       | C   | 5,270                  | 0     |
| 129        | Pacific Ave  | At Calaveras River  | 0             | 33,150           | 4                  | Arterial       | E   | 29,300            | 4                  | Arterial       | C   | -3,850                 | 0     |
| 130        | Pacific Ave  | Cleveland           | Wyandotte     | 20,160           | 4                  | Arterial       | B   | 20,400            | 4                  | Arterial       | A   | 240                    | 0     |
| 131        | Fresno Ave   | Washington St       | Navy Dr       | 11,850           | 2                  | Collector      | E   | 2,370             | 2                  | Collector      | A   | -9,480                 | 0     |
| 132        | Fresno Ave   | Navy Dr             | Charter Way   | 10,320           | 2                  | Collector      | D   | 5,110             | 2                  | Collector      | A   | -5,210                 | 0     |
| 133        | Fresno Ave   | Charter Way         | 8th Street    | 8,090            | 2                  | Collector      | C   | 7,720             | 2                  | Collector      | C   | -370                   | 0     |
| 134        | El Dorado St | Lincoln             | Loretta       | 17,820           | 4                  | Arterial       | A   | 17,800            | 4                  | Arterial       | A   | -20                    | 0     |
| 135        | El Dorado St | Mayfair             | Robinhood     | 29,200           | 4                  | Arterial       | D   | 32,100            | 4                  | Arterial       | C   | 2,900                  | 0     |
| 136        | El Dorado St | At Calaveras River  | 0             | 29,050           | 4                  | Arterial       | D   | 21,800            | 4                  | Arterial       | A   | -7,250                 | 0     |
| 137        | El Dorado St | Pine                | Cleveland     | 23,940           | 6                  | Arterial       | A   | 21,800            | 6                  | Arterial       | A   | -2,140                 | 0     |
| 138        | El Dorado St | Lindsay             | Miner         | 20,590           | 3                  | Arterial       | D   | 22,600            | 3                  | Arterial       | C   | 2,010                  | 0     |
| 139        | El Dorado St | At AT & SF Overpass | 0             | 15,410           | 3                  | Arterial       | C   | 17,700            | 3                  | Arterial       | B   | 2,290                  | 0     |



**TABLE 5**  
**STOCKTON GENERAL PLAN - ROADWAY OPERATIONS**

| Segment ID | Roadway       | Between             |                   | Base Year        |                    |                |     | 2040 Plus Project |                    |                |     | Change: Base to Future |       |
|------------|---------------|---------------------|-------------------|------------------|--------------------|----------------|-----|-------------------|--------------------|----------------|-----|------------------------|-------|
|            |               |                     |                   | ADT <sup>1</sup> | Lanes <sup>2</sup> | Classification | LOS | ADT <sup>1</sup>  | Lanes <sup>2</sup> | Classification | LOS | ADT                    | Lanes |
| 140        | El Dorado St  | MLK Blvd            | First             | 12,270           | 3                  | Arterial       | A   | 13,600            | 3                  | Arterial       | A   | 1,330                  | 0     |
| 141        | El Dorado St  | Eighth              | Ninth             | 13,910           | 4                  | Arterial       | A   | 18,900            | 4                  | Arterial       | A   | 4,990                  | 0     |
| 142        | California St | Alpine              | Harding           | 18,070           | 4                  | Arterial       | A   | 19,100            | 2                  | Arterial       | E   | 1,030                  | -2    |
| 143        | California St | Harding             | Park              | 11,530           | 4                  | Arterial       | A   | 21,700            | 2                  | Arterial       | F   | 10,170                 | -2    |
| 144        | California St | Park                | Weber             | 8,050            | 4                  | Arterial       | A   | 19,100            | 4                  | Arterial       | A   | 11,050                 | 0     |
| 145        | California St | Weber               | Crosstown Freeway | 5,460            | 4                  | Arterial       | A   | 16,300            | 4                  | Arterial       | A   | 10,840                 | 0     |
| 146        | Center St     | Poplar              | Flora             | 16,180           | 3                  | Arterial       | C   | 14,400            | 3                  | Arterial       | A   | -1,780                 | 0     |
| 147        | Center St     | At AT & SF Overpass | 0                 | 15,690           | 3                  | Arterial       | C   | 18,800            | 3                  | Arterial       | C   | 3,110                  | 0     |
| 148        | Holman Rd     | 8 Mile              | Morada            | 9,530            | 6                  | Arterial       | A   | 10,200            | 4                  | Arterial       | A   | 670                    | -2    |
| 149        | Holman Rd     | Morada Lane         | Hammer            | 17,850           | 6                  | Arterial       | A   | 18,200            | 4                  | Arterial       | A   | 350                    | -2    |
| 150        | Holman Rd     | Auto Center         | Auto Center       | 18,230           | 6                  | Arterial       | A   | 18,100            | 4                  | Arterial       | A   | -130                   | -2    |
| 151        | Holman Rd     | Wind Flower         | March             | 15,500           | 2                  | Local          | A   | 6,100             | 2                  | Local          | A   | -9,400                 | 0     |
| 152        | Cherokee Rd   | Sierra              | Sanguinetti       | 6,420            | 2                  | Arterial       | A   | 12,600            | 2                  | Arterial       | C   | 6,180                  | 0     |
| 153        | Waterloo Rd   | E                   | Williams          | 13,890           | 4                  | Arterial       | A   | 13,000            | 4                  | Arterial       | A   | -890                   | 0     |
| 154        | Airport Way   | Pinchot             | Roosevelt         | 19,900           | 4                  | Arterial       | B   | 34,000            | 6                  | Arterial       | B   | 14,100                 | 2     |
| 155        | Airport Way   | Fremont             | Lindsay           | 20,430           | 4                  | Arterial       | B   | 35,000            | 6                  | Arterial       | B   | 14,570                 | 2     |
| 156        | Airport Way   | Main                | Market            | 16,720           | 4                  | Arterial       | A   | 33,600            | 6                  | Arterial       | B   | 16,880                 | 2     |
| 157        | Airport Way   | Ninth               | Tenth             | 21,760           | 4                  | Arterial       | C   | 49,400            | 6                  | Arterial       | D   | 27,640                 | 2     |
| 158        | Airport Way   | Sperry              | Industrial        | 16,630           | 4                  | Arterial       | A   | 31,400            | 6                  | Arterial       | A   | 14,770                 | 2     |
| 159        | Airport Way   | Sperry              | CE Dixon St       | 14,330           | 4                  | Arterial       | A   | 37,400            | 4                  | Arterial       | D   | 23,070                 | 0     |
| 160        | Mariposa Rd   | Stagecoach          | SR 99             | 11,300           | 6                  | Arterial       | A   | 53,600            | 6                  | Arterial       | D   | 42,300                 | 0     |



**TABLE 5**  
**STOCKTON GENERAL PLAN - ROADWAY OPERATIONS**

| Segment ID | Roadway        | Between         |                  | Base Year        |                    |                |     | 2040 Plus Project |                    |                |     | Change: Base to Future |       |
|------------|----------------|-----------------|------------------|------------------|--------------------|----------------|-----|-------------------|--------------------|----------------|-----|------------------------|-------|
|            |                |                 |                  | ADT <sup>1</sup> | Lanes <sup>2</sup> | Classification | LOS | ADT <sup>1</sup>  | Lanes <sup>2</sup> | Classification | LOS | ADT                    | Lanes |
| 161        | Mariposa Rd    | Farmington      | SR 99            | 12,290           | 2                  | Arterial       | D   | 23,700            | 6                  | Arterial       | A   | 11,410                 | 4     |
| 162        | Mariposa Rd    | MLK Blvd        | Farmington       | 14,260           | 2                  | Arterial       | D   | 26,300            | 6                  | Arterial       | A   | 12,040                 | 4     |
| 163        | B St           | Charter Way     | Fourth           | 13,530           | 2                  | Collector      | F   | 14,400            | 2                  | Collector      | F   | 870                    | 0     |
| 164        | B St           | Ralph Ave       | Arch Airport     | 4,540            | 2                  | Local          | A   | 11,400            | 2                  | Local          | A   | 6,860                  | 0     |
| 165        | Pock Lane      | Mariposa        | Sixth            | 3,720            | 2                  | Collector      | A   | 5,600             | 2                  | Collector      | A   | 1,880                  | 0     |
| 166        | Pock Lane      | Togninali       | Carpenter        | 5,170            | 2                  | Local          | A   | 7,800             | 2                  | Local          | A   | 2,630                  | 0     |
| 167        | Jack Tone Road | Eight Mile Road | SR 26            | 2,285            | 2                  | Arterial       | A   | 3,400             | 2                  | Arterial       | A   | 1,115                  | 0     |
| 168        | Jack Tone Road | SR 26           | Mariposa Rd      | 2,880            | 2                  | Arterial       | A   | 3,400             | 2                  | Arterial       | A   | 520                    | 0     |
| 169        | Jack Tone Road | Mariposa Road   | French Camp Road | 4,714            | 2                  | Arterial       | A   | 5,400             | 2                  | Arterial       | A   | 686                    | 0     |
| 170        | Roth Road      | I-5             | Airport Way      | 5,320            | 2                  | Collector      | A   | 8,800             | 2                  | Collector      | C   | 3,480                  | 0     |

Source: Data compiled by Fehr & Peers in 2017 based on numerous data sources reflecting traffic counts collected in 2012, 2014 and 2016, all normalized to 2016.

- Notes:
1. Represents total traffic volume on the roadway segment.
  2. Represents number of lanes per direction.





## MODEL DATA

Fehr & Peers used the updated City of Stockton General Plan model to estimate a number of transportation metrics, including mode share and vehicle miles of travel for both the existing condition and updated General Plan condition. Metrics were created for two geographies. The first is the current incorporated City of Stockton boundary. The second includes the City of Stockton, the proposed Sphere of Influence (SOI), and other unincorporated areas within the immediate vicinity of Stockton, including the incorporated County pockets surrounded by the incorporated city limits (Planning Area).

### *Demographic Data*

A summary of the number of households, population, and employment used in the travel modeling is summarized in **Table 6** for both the incorporated City of Stockton as well as the larger planning area. Population and employment growth is expected to occur at a faster rate in areas outside the current City of Stockton city limits. Much of this growth is projected to occur in areas where development has been approved, such as Mariposa Lakes, but the land has not yet been annexed into the City of Stockton.

**TABLE 6  
 DEMOGRAPHIC SUMMARY**

| Demographic Factor | City of Stockton |              | Planning Area |              |
|--------------------|------------------|--------------|---------------|--------------|
|                    | Base Year        | General Plan | Base Year     | General Plan |
| Households         | 98,400           | 117,200      | 116,300       | 157,200      |
| Population         | 305,900          | 357,000      | 363,300       | 484,100      |
| Employment         | 110,100          | 148,700      | 123,400       | 187,700      |

Source: City of Stockton General Plan Model, Fehr & Peers, 2017, and PlaceWorks, 2017.

### *Mode Share*

The mode of travel for trips with at least one end in Stockton, and the entire planning area were calculated based on the model, as presented in **Table 7**. On a daily basis, approximately 680,000 person trips are generated by the variety of land uses within the City of Stockton, with approximately 89 percent of these trips occurring via an auto-mode, 2 percent via transit, 7 percent via walking, and 1 percent via bicycling. Higher levels of walking, biking and transit use occur within



the City of Stockton boundaries as compared to the overall Planning Area. Under General Plan conditions, the walk, bike and transit mode shares are expected to increase within the City of Stockton limits from approximately 11 percent of all trips to almost 15 percent of all trips. Non-auto trips within the entire planning area are expected to increase slightly from the existing condition.

**TABLE 7**  
**BASE YEAR MODE SHARE - CITY OF STOCKTON**  
**PERSON TRIPS, INCLUDES I-I, I-X, X-I**

| Mode           | Base Year        |         |               |         | General Plan     |         |               |         |
|----------------|------------------|---------|---------------|---------|------------------|---------|---------------|---------|
|                | City of Stockton |         | Planning Area |         | City of Stockton |         | Planning Area |         |
|                | Person Trips     | Percent | Person Trips  | Percent | Person Trips     | Percent | Person Trips  | Percent |
| Drive Alone    | 242,800          | 35.6%   | 593,100       | 38.4%   | 296,400          | 32.7%   | 774,600       | 37.0%   |
| Shared Ride 2  | 170,700          | 25.0%   | 383,800       | 24.9%   | 224,600          | 24.8%   | 523,100       | 25.0%   |
| Shared Ride 3+ | 194,300          | 28.5%   | 436,400       | 28.3%   | 249,100          | 27.5%   | 576,800       | 27.6%   |
| Transit        | 14,500           | 2.1%    | 24,900        | 1.6%    | 32,500           | 3.6%    | 53,100        | 2.5%    |
| Walk           | 50,200           | 7.4%    | 87,800        | 5.7%    | 85,400           | 9.4%    | 134,400       | 6.4%    |
| Bike           | 9,400            | 1.4%    | 17,900        | 1.2%    | 17,400           | 1.9%    | 30,400        | 1.5%    |
| Total          | 681,900          | 100.0%  | 1,543,900     | 100.0%  | 905,400          | 100.0%  | 2,092,400     | 100.0%  |

Source: City of Stockton General Plan Model, Fehr & Peers, 2017.

### **Internal/External Trips**

The general origin/destination of person trips generated in the City of Stockton and the Planning area was also calculated with the percent that occur entirely within Stockton, or are imported/exported trips is shown in **Table 8**. Approximately 73 percent of existing person trips have both trip ends within Stockton, while the remaining trips have either an origin or destination outside the City limits. This percentage is predicted to increase under General Plan conditions.





Within the overall planning area, the number of internal trips is slightly less than within the City limits, but the percentage is also projected to increase under General Plan conditions indicating that the land use mixture proposed under the General Plan has the potential to serve more daily needs within the planning area, reducing the demand for travel outside the area.

**TABLE 8**  
**IMPORT/EXPORT OF PERSON TRIPS ALL MODES**

| Trip Type                        | Base Year        |               |                  |               | General Plan     |               |                  |               |
|----------------------------------|------------------|---------------|------------------|---------------|------------------|---------------|------------------|---------------|
|                                  | City of Stockton |               | Planning Area    |               | City of Stockton |               | Planning Area    |               |
|                                  | Person Trips     | Percent       | Person Trips     | Percent       | Person Trips     | Percent       | Person Trips     | Percent       |
| I-I (internal trips)             | 499,200          | 73.2%         | 1,039,600        | 67.3%         | 716,600          | 79.1%         | 1,495,400        | 71.5%         |
| I-X (from Stockton to elsewhere) | 126,700          | 18.6%         | 262,400          | 17.0%         | 98,500           | 10.9%         | 206,500          | 9.9%          |
| X-I (from elsewhere to Stockton) | 56,200           | 8.2%          | 241,900          | 15.7%         | 90,800           | 10.0%         | 390,500          | 18.7%         |
| <b>Total</b>                     | <b>682,100</b>   | <b>100.0%</b> | <b>1,543,900</b> | <b>100.0%</b> | <b>905,900</b>   | <b>100.0%</b> | <b>2,092,400</b> | <b>100.0%</b> |

Source: City of Stockton General Plan Model, Fehr & Peers, 2017.

### **Vehicle Miles of Travel (VMT)**

To assess the VMT generated by the project, two methods were used. The first method tracks all vehicular trips generated by the City of Stockton or Planning across the entire regional network. The second method captures only vehicle trips made within the City of Stockton or Planning boundaries, regardless of their origin or destination (boundary method). Each method is discussed in more detail below.

#### **Boundary Method**

A boundary based estimate captures all the VMT on a roadway network within a specified geographic area such as the city limits. A limitation of this method is that it does not capture trips that extend beyond a jurisdiction's boundary and includes through traffic on regional roadway facilities. However, this information can be useful in estimating total greenhouse gas emissions



within a specified geographic area. The base year VMT on roadways within Stockton is shown in **Table 9** by vehicle speed. It should be noted that the model was not validated to speeds and the model does not contain local streets which may have lower traffic volumes. The model also assumes maximum travel speeds on roadways close to the posted speed limit.

**TABLE 9**  
**VMT BOUNDARY METHOD**

| Speed Bin    | Base Year        |         |               |         | General Plan     |         |               |         |
|--------------|------------------|---------|---------------|---------|------------------|---------|---------------|---------|
|              | City of Stockton |         | Planning Area |         | City of Stockton |         | Planning Area |         |
|              | Number           | Percent | Number        | Percent | Number           | Percent | Number        | Percent |
| 0.00-7.50    | 2,000            | 0.0%    | 3,600         | 0.0%    | 4,700            | 0.1%    | 9,100         | 0.1%    |
| 7.51-12.50   | 5,900            | 0.1%    | 9,400         | 0.1%    | 15,700           | 0.2%    | 24,000        | 0.2%    |
| 12.51-17.50  | 10,800           | 0.2%    | 15,100        | 0.2%    | 16,500           | 0.3%    | 26,000        | 0.2%    |
| 17.51-22.50  | 41,800           | 0.9%    | 61,100        | 0.7%    | 71,500           | 1.1%    | 106,000       | 0.9%    |
| 22.51-27.50  | 320,300          | 6.5%    | 387,600       | 4.6%    | 454,900          | 7.2%    | 577,000       | 4.9%    |
| 27.51-32.50  | 451,600          | 9.2%    | 525,900       | 6.2%    | 653,300          | 10.4%   | 822,700       | 7.0%    |
| 32.51-37.50  | 650,100          | 13.2%   | 842,000       | 10.0%   | 744,100          | 11.8%   | 1,024,100     | 8.7%    |
| 37.51-42.50  | 986,000          | 20.1%   | 1,187,900     | 14.1%   | 1,092,400        | 17.3%   | 1,503,700     | 12.8%   |
| 42.51-47.60  | 429,800          | 8.8%    | 899,500       | 10.6%   | 466,800          | 7.4%    | 1,385,400     | 11.8%   |
| 47.61-52.50  | 63,800           | 1.3%    | 262,200       | 3.1%    | 122,900          | 2.0%    | 485,200       | 4.1%    |
| 52.51-57.50  | 53,800           | 1.1%    | 160,300       | 1.9%    | 91,900           | 1.5%    | 241,000       | 2.1%    |
| 57.51-62.50  | 201,800          | 4.1%    | 355,000       | 4.2%    | 271,900          | 4.3%    | 481,100       | 4.1%    |
| 62.51-67.50  | 1,693,900        | 34.5%   | 3,744,300     | 44.3%   | 2,289,700        | 36.4%   | 5,056,500     | 43.1%   |
| 67.51-72.50  | 0                | 0.0%    | 0             | 0.0%    | 0                | 0.0%    | 0             | 0.0%    |
| <b>Total</b> | 4,911,600        | 100.0%  | 8,453,900     | 100.0%  | 6,296,300        | 100.0%  | 11,741,800    | 100.0%  |

Source: City of Stockton General Plan Model, Fehr & Peers, 2017.



### **Origin-Destination Method – Total Accounting**

An origin-destination (OD) method tracks all vehicular trips generated by the City of Stockton across the entire regional network. Four types of trips are isolated:

- Internal-Internal (II) trips: Include all trips that begin and end within the City of Stockton.
- Internal-External (IX) trips: Include all trips that begin in within city limits and end outside city limits.
- External-Internal (XI) trips: Include all trips that begin outside city limits and end inside city limits.
- External-External (XX) trips: Trips that begin and end outside the City of Stockton are not included. The City of Stockton assumes no responsibility for External-External trip type VMTs.

To estimate VMT per service population, trips are multiplied by the trip distance for all trip types to estimate VMT and then divided by the sum of residential and working population of the City of Stockton. As shown in **Table 10**, land uses within Stockton generate approximately 11,255,000 vehicle miles of travel on a daily basis.



**TABLE 10**  
**VMT ORIGIN-DESTINATION METHOD (ENTIRE LENGTH OF TRIP)**

| Speed Bin    | Base Year         |               |                   |               | General Plan      |               |                   |               |
|--------------|-------------------|---------------|-------------------|---------------|-------------------|---------------|-------------------|---------------|
|              | City of Stockton  |               | Planning Area     |               | City of Stockton  |               | Planning Area     |               |
|              | Number            | Percent       | Number            | Percent       | Number            | Percent       | Number            | Percent       |
| 0.00-7.50    | 3,500             | 0.0%          | 3,600             | 0.0%          | 20,000            | 0.1%          | 23,000            | 0.1%          |
| 7.51-12.50   | 7,400             | 0.1%          | 7,700             | 0.1%          | 29,600            | 0.2%          | 33,400            | 0.2%          |
| 12.51-17.50  | 23,100            | 0.2%          | 24,800            | 0.2%          | 24,600            | 0.2%          | 27,400            | 0.2%          |
| 17.51-22.50  | 77,000            | 0.7%          | 83,100            | 0.7%          | 103,900           | 0.7%          | 116,000           | 0.7%          |
| 22.51-27.50  | 395,200           | 3.5%          | 416,400           | 3.3%          | 556,400           | 3.9%          | 604,200           | 3.7%          |
| 27.51-32.50  | 1,010,700         | 8.9%          | 1,071,300         | 8.6%          | 1,379,700         | 9.7%          | 1,501,800         | 9.3%          |
| 32.51-37.50  | 761,200           | 6.7%          | 810,800           | 6.5%          | 944,700           | 6.7%          | 1,033,800         | 6.4%          |
| 37.51-42.50  | 1,135,900         | 10.0%         | 1,189,200         | 9.5%          | 1,443,100         | 10.2%         | 1,558,400         | 9.6%          |
| 42.51-47.60  | 1,057,700         | 9.3%          | 1,169,100         | 9.4%          | 1,380,100         | 9.7%          | 1,600,500         | 9.9%          |
| 47.61-52.50  | 437,600           | 3.9%          | 490,800           | 3.9%          | 623,300           | 4.4%          | 735,700           | 4.5%          |
| 52.51-57.50  | 154,900           | 1.4%          | 171,400           | 1.4%          | 411,700           | 2.9%          | 487,100           | 3.0%          |
| 57.51-62.50  | 255,300           | 2.3%          | 276,500           | 2.2%          | 613,000           | 4.3%          | 705,400           | 4.3%          |
| 62.51-67.50  | 6,023,900         | 53.1%         | 6,758,700         | 54.2%         | 6,675,200         | 47.0%         | 7,806,900         | 48.1%         |
| 67.51-72.50  | 0                 | 0.0%          | 0                 | 0.0%          | 0                 | 0.0%          | 0                 | 0.0%          |
| <b>Total</b> | <b>11,343,400</b> | <b>100.0%</b> | <b>12,473,400</b> | <b>100.0%</b> | <b>14,205,300</b> | <b>100.0%</b> | <b>16,233,600</b> | <b>100.0%</b> |

Source: City of Stockton General Plan Model, Fehr & Peers, 2017.



To normalize vehicle miles of travel to other demographic factors, the VMT per service population was calculated as summarized below in **Table 11**.

**TABLE 11**  
**VEHICLE MILES OF TRAVEL BY SERVICE POPULATION**

|   | Base Year        |               | General Plan     |               |
|---|------------------|---------------|------------------|---------------|
|   | City of Stockton | Planning Area | City of Stockton | Planning Area |
| VMT (O-D)   | 11,343,400       | 12,473,400    | 14,205,300       | 16,233,600    |
| Population  | 305,900          | 363,300       | 357,000          | 484,100       |
| Employment  | 110,100          | 123,400       | 148,700          | 187,700       |
| Service Population<br>(sum of population and<br>employment) | 416,000          | 486,700       | 505,700          | 671,800       |
| VMT per Service<br>Population                               | 27.27            | 25.63         | 28.09            | 24.16         |
| Percent Change from Base Year                               |                  |               | 3%               | -6%           |

Source: City of Stockton General Plan Model, Fehr & Peers, 2017.

The net change in vehicle miles of travel was also calculated to isolate the VMT associated with new development in combination with other City policies that could affect existing and future travel patterns. The results are presented in **Table 12**, which indicates that new development in Stockton is expected to generate approximately 20 percent less vehicle miles of travel than existing development when coupled with other changes to the transportation system. This indicates that many new development projects could achieve a 15 percent VMT reduction from baseline (requirement of SB 743), provided that other goals and policies of the General Plan are in place.



**TABLE 12  
 NET CHANGE IN VMT FOR PLANNING AREA**

|                            | Base Year  | Proposed Plan |            |
|----------------------------|------------|---------------|------------|
|                            | Total      | Total         | Net Change |
| VMT (O-D)                  | 12,473,400 | 16,233,600    | 3,866,900  |
| Population                 | 363,300    | 484,100       | 120,800    |
| Employment                 | 123,400    | 187,700       | 64,300     |
| Service Population         | 486,700    | 671,800       | 185,100    |
| VMT per Service Population | 25.63      | 24.16         | 20.31      |
| Net Change from Baseline   |            | -6%           | -21%       |

Source: City of Stockton General Plan Model, Fehr & Peers, 2017.

This completes our General Plan condition analysis for the Stockton General Plan. Please contact Kathrin at (925) 930-7100 with questions.

Attachments:

Figure 1 Peak Hour Intersection Study Locations

Figure 2 Peak Hour Intersection Turning Movement Data and Traffic Control

Attachment A Peak Hour Intersection Traffic Counts

Attachment B Peak Hour Intersection Level of Service Worksheets

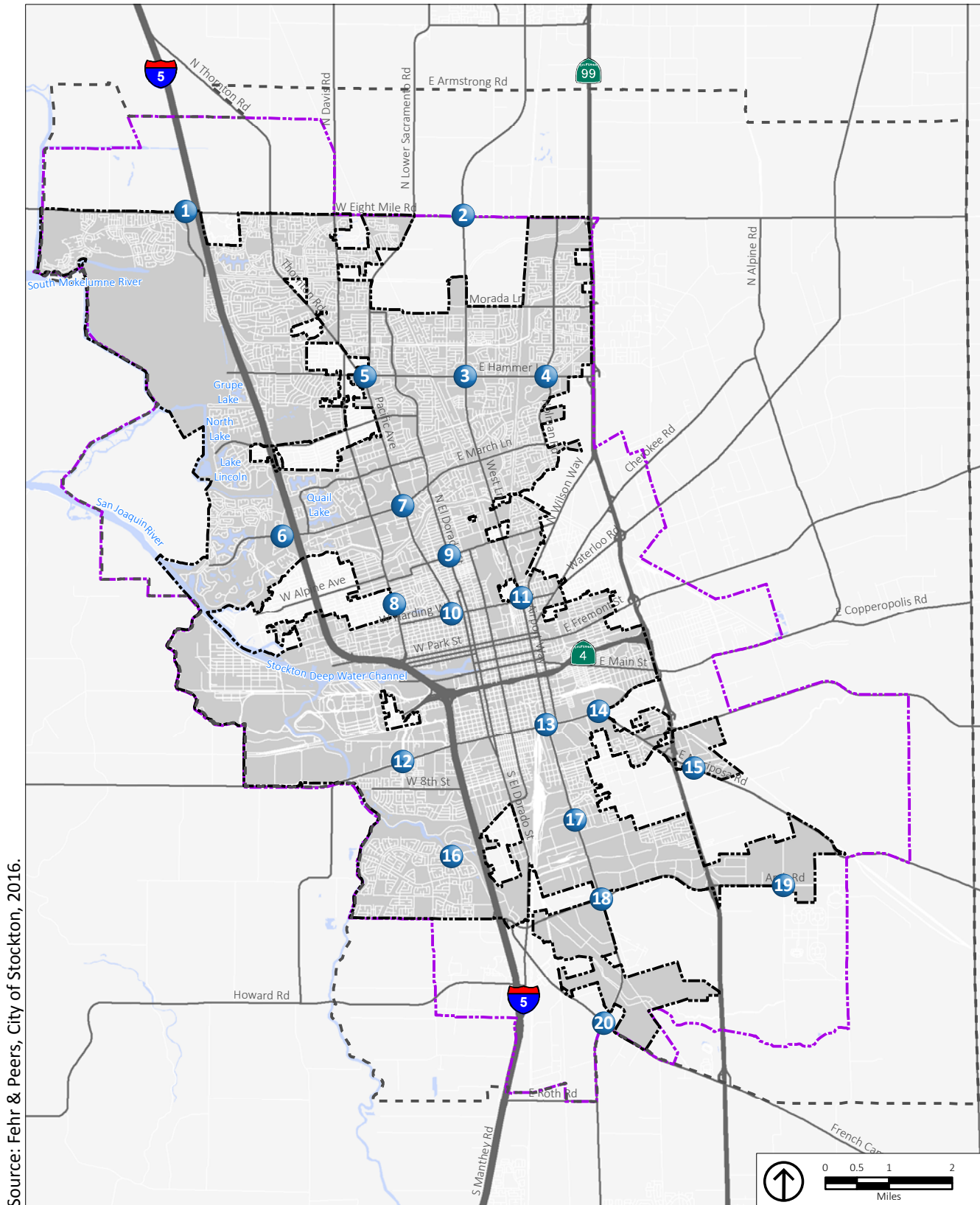

Source: Fehr & Peers, City of Stockton, 2016.

- # Study Intersection
- General Plan Planning Area
- City Limit
- Sphere of Influence

Figure 1  
 Study Intersections





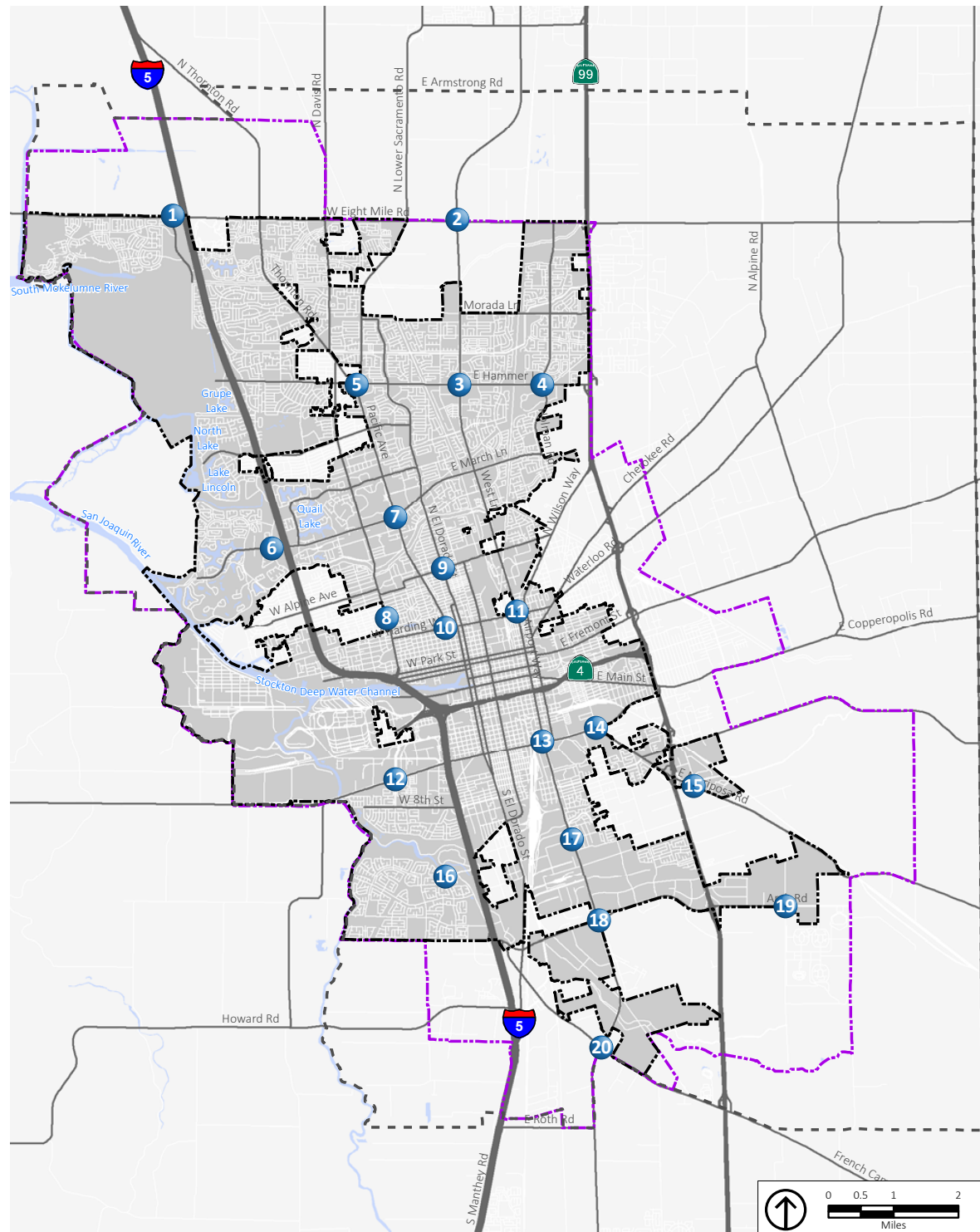

|   |  |  |   |   |
|---|--|--|---|---|
| <b>1. Trinity Parkway/Eight Mile Road</b><br>     | <b>2. West Lane/Eight Mile Road</b><br>  | <b>3. West Lane/Hammer Lane</b><br>                      | <b>4. Holman Road/Hammer Lane</b><br>                               | <b>5. Thornton Rd/Pacific Ave/Rivara Rd/Lower Sacramento Rd</b><br> |
| <b>6. Feather River Drive/March Lane</b><br>      | <b>7. Pacific Avenue/March Lane</b><br>  | <b>8. Pershing Avenue/Country Club Boulevard</b><br>     | <b>9. El Dorado Street/Alpine Avenue</b><br>                        | <b>10. Pacific Avenue/Harding Way</b><br>                           |
| <b>11. West Lane/Airport Way/Harding Way</b><br>  | <b>12. Fresno Avenue/Charter Way</b><br> | <b>13. Airport Way/Dr Martin Luther King Jr Blvd</b><br> | <b>14. Diamond St/Mariposa Rd/Dr Martin Luther King Jr Blvd</b><br> | <b>15. Stagecoach Road/Mariposa Road</b><br>                        |
| <b>16. McDougald Blvd/Carolyn Weston Blvd</b><br> | <b>17. Airport Way/Ralph Avenue</b><br>  | <b>18. Airport Way/Sperry Road/Arch Airport Road</b><br> | <b>19. Newcastle Road/Arch Road</b><br>                             | <b>20. Airport Way/French Camp Road</b><br>                         |

**LEGEND**

XX (YY) AM (PM) Peak Hour Traffic Volumes Signalized Intersection Stop Sign

Study Intersection

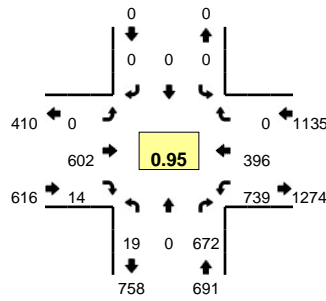

Figure 2  
Existing Peak Hour  
Intersection Traffic Volumes, Lane Configurations and Traffic Controls



**LOCATION:** 1. Trinity Pkwy -- Eight Mile Rd  
**CITY/STATE:** Stockton, CA

**QC JOB #:** 14437901  
**DATE:** Thu, Jun 01 2017



**Peak-Hour: 7:35 AM -- 8:35 AM**  
**Peak 15-Min: 7:40 AM -- 7:55 AM**

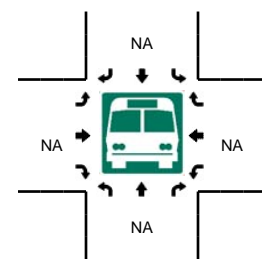
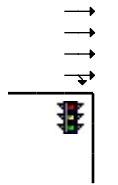
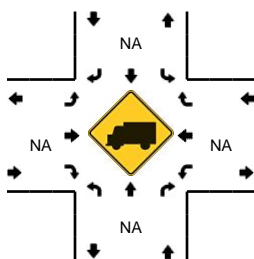
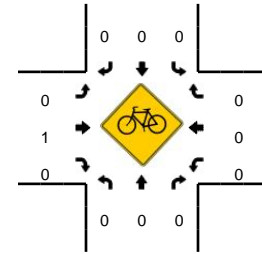
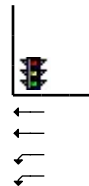
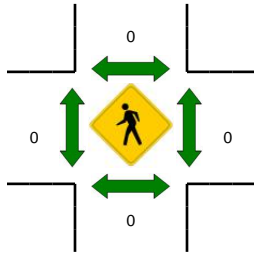
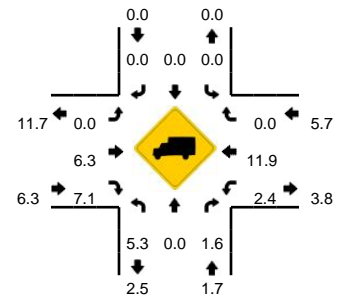

| 5-Min Count Period Beginning At | 1. Trinity Pkwy (Northbound) |      |       |   | 1. Trinity Pkwy (Southbound) |      |       |   | Eight Mile Rd (Eastbound) |      |       |   | Eight Mile Rd (Westbound) |      |       |   | Total | Hourly Totals |
|---------------------------------|------------------------------|------|-------|---|------------------------------|------|-------|---|---------------------------|------|-------|---|---------------------------|------|-------|---|-------|---------------|
|                                 | Left                         | Thru | Right | U | Left                         | Thru | Right | U | Left                      | Thru | Right | U | Left                      | Thru | Right | U |       |               |
| 7:00 AM                         | 1                            | 0    | 41    | 0 | 0                            | 0    | 0     | 0 | 0                         | 41   | 1     | 0 | 27                        | 20   | 0     | 0 | 131   |               |
| 7:05 AM                         | 9                            | 0    | 57    | 0 | 0                            | 0    | 0     | 0 | 0                         | 46   | 1     | 0 | 28                        | 21   | 0     | 0 | 162   |               |
| 7:10 AM                         | 0                            | 0    | 53    | 0 | 0                            | 0    | 0     | 0 | 0                         | 51   | 1     | 0 | 33                        | 16   | 0     | 0 | 154   |               |
| 7:15 AM                         | 0                            | 0    | 41    | 0 | 0                            | 0    | 0     | 0 | 0                         | 41   | 0     | 0 | 33                        | 19   | 0     | 0 | 134   |               |
| 7:20 AM                         | 1                            | 0    | 58    | 1 | 0                            | 0    | 0     | 0 | 0                         | 43   | 3     | 0 | 45                        | 18   | 0     | 0 | 169   |               |
| 7:25 AM                         | 0                            | 0    | 57    | 0 | 0                            | 0    | 0     | 0 | 0                         | 35   | 1     | 0 | 38                        | 26   | 0     | 0 | 157   |               |
| 7:30 AM                         | 1                            | 0    | 54    | 0 | 0                            | 0    | 0     | 0 | 0                         | 56   | 3     | 0 | 42                        | 27   | 0     | 0 | 183   |               |
| 7:35 AM                         | 2                            | 0    | 61    | 0 | 0                            | 0    | 0     | 0 | 0                         | 49   | 2     | 0 | 53                        | 22   | 0     | 0 | 189   |               |
| 7:40 AM                         | 2                            | 0    | 75    | 0 | 0                            | 0    | 0     | 0 | 0                         | 61   | 1     | 0 | 39                        | 31   | 0     | 0 | 209   |               |
| 7:45 AM                         | 1                            | 0    | 61    | 0 | 0                            | 0    | 0     | 0 | 0                         | 60   | 0     | 0 | 61                        | 38   | 0     | 0 | 221   |               |
| 7:50 AM                         | 1                            | 0    | 57    | 0 | 0                            | 0    | 0     | 0 | 0                         | 57   | 0     | 0 | 62                        | 33   | 0     | 0 | 210   |               |
| 7:55 AM                         | 0                            | 0    | 40    | 1 | 0                            | 0    | 0     | 0 | 0                         | 56   | 2     | 0 | 61                        | 46   | 0     | 0 | 206   | 2125          |
| 8:00 AM                         | 1                            | 0    | 41    | 1 | 0                            | 0    | 0     | 0 | 0                         | 42   | 2     | 0 | 71                        | 41   | 0     | 0 | 199   | 2193          |
| 8:05 AM                         | 0                            | 0    | 39    | 0 | 0                            | 0    | 0     | 0 | 0                         | 62   | 0     | 0 | 69                        | 38   | 0     | 0 | 208   | 2239          |
| 8:10 AM                         | 1                            | 0    | 51    | 2 | 0                            | 0    | 0     | 0 | 0                         | 46   | 3     | 0 | 63                        | 43   | 0     | 0 | 209   | 2294          |
| 8:15 AM                         | 1                            | 0    | 67    | 1 | 0                            | 0    | 0     | 0 | 0                         | 42   | 2     | 0 | 54                        | 24   | 0     | 0 | 191   | 2351          |
| 8:20 AM                         | 0                            | 0    | 56    | 0 | 0                            | 0    | 0     | 0 | 0                         | 55   | 1     | 0 | 65                        | 26   | 0     | 0 | 203   | 2385          |
| 8:25 AM                         | 4                            | 0    | 64    | 0 | 0                            | 0    | 0     | 0 | 0                         | 42   | 1     | 0 | 66                        | 27   | 0     | 0 | 204   | 2432          |
| 8:30 AM                         | 1                            | 0    | 60    | 0 | 0                            | 0    | 0     | 0 | 0                         | 30   | 0     | 0 | 75                        | 27   | 0     | 0 | 193   | 2442          |
| 8:35 AM                         | 0                            | 0    | 61    | 0 | 0                            | 0    | 0     | 0 | 0                         | 26   | 1     | 0 | 70                        | 21   | 0     | 0 | 179   | 2432          |
| 8:40 AM                         | 4                            | 0    | 60    | 0 | 0                            | 0    | 0     | 0 | 0                         | 33   | 2     | 0 | 66                        | 19   | 0     | 0 | 184   | 2407          |
| 8:45 AM                         | 0                            | 0    | 69    | 0 | 0                            | 0    | 0     | 0 | 0                         | 27   | 3     | 0 | 67                        | 11   | 0     | 0 | 177   | 2363          |
| 8:50 AM                         | 0                            | 0    | 57    | 0 | 0                            | 0    | 0     | 0 | 0                         | 34   | 3     | 0 | 58                        | 22   | 0     | 0 | 174   | 2327          |
| 8:55 AM                         | 1                            | 0    | 60    | 0 | 0                            | 0    | 0     | 0 | 0                         | 22   | 0     | 0 | 69                        | 18   | 0     | 0 | 170   | 2291          |
| Peak 15-Min Flowrates           | Northbound                   |      |       |   | Southbound                   |      |       |   | Eastbound                 |      |       |   | Westbound                 |      |       |   | Total |               |
|                                 | Left                         | Thru | Right | U | Left                         | Thru | Right | U | Left                      | Thru | Right | U | Left                      | Thru | Right | U |       |               |
| All Vehicles                    | 16                           | 0    | 772   | 0 | 0                            | 0    | 0     | 0 | 0                         | 712  | 4     | 0 | 648                       | 408  | 0     | 0 | 2560  |               |
| Heavy Trucks                    | 0                            | 0    | 16    | 0 | 0                            | 0    | 0     | 0 | 0                         | 20   | 0     | 0 | 16                        | 40   | 0     | 0 | 92    |               |
| Pedestrians                     |                              |      | 0     |   |                              |      | 0     |   |                           | 0    |       |   |                           | 0    |       |   | 0     |               |
| Bicycles                        | 0                            | 0    | 0     |   | 0                            | 0    | 0     |   | 0                         | 0    | 0     |   | 0                         | 0    | 0     |   | 0     |               |
| Railroad                        |                              |      |       |   |                              |      |       |   |                           |      |       |   |                           |      |       |   |       |               |
| Stopped Buses                   |                              |      |       |   |                              |      |       |   |                           |      |       |   |                           |      |       |   |       |               |

Comments:

**LOCATION:** 1. Trinity Pkwy -- Eight Mile Rd  
**CITY/STATE:** Stockton, CA

**QC JOB #:** 14437902  
**DATE:** Thu, Jun 01 2017

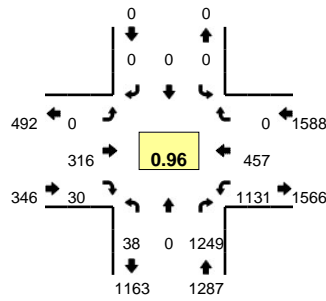

**Peak-Hour: 4:40 PM -- 5:40 PM**  
**Peak 15-Min: 5:15 PM -- 5:30 PM**

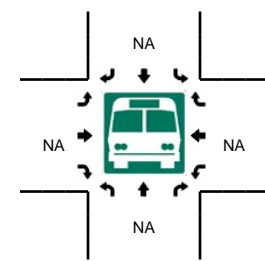
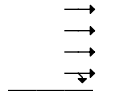
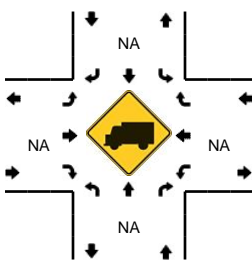
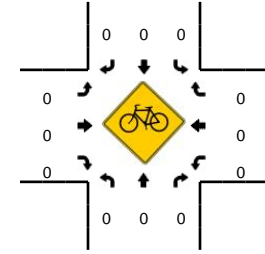
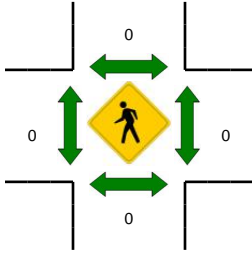
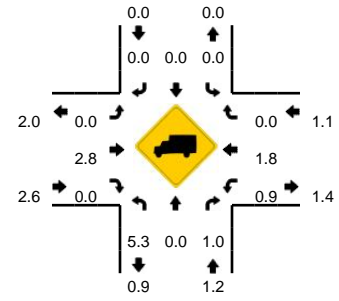

| 5-Min Count Period Beginning At | 1. Trinity Pkwy (Northbound) |      |       |   | 1. Trinity Pkwy (Southbound) |      |       |   | Eight Mile Rd (Eastbound) |      |       |   | Eight Mile Rd (Westbound) |      |       |   | Total | Hourly Totals |
|---------------------------------|------------------------------|------|-------|---|------------------------------|------|-------|---|---------------------------|------|-------|---|---------------------------|------|-------|---|-------|---------------|
|                                 | Left                         | Thru | Right | U | Left                         | Thru | Right | U | Left                      | Thru | Right | U | Left                      | Thru | Right | U |       |               |
| 4:00 PM                         | 0                            | 0    | 93    | 0 | 0                            | 0    | 0     | 0 | 0                         | 27   | 2     | 0 | 89                        | 31   | 0     | 0 | 242   |               |
| 4:05 PM                         | 1                            | 0    | 92    | 1 | 0                            | 0    | 0     | 0 | 0                         | 17   | 2     | 0 | 92                        | 37   | 0     | 0 | 242   |               |
| 4:10 PM                         | 3                            | 0    | 93    | 1 | 0                            | 0    | 0     | 0 | 0                         | 23   | 4     | 0 | 80                        | 38   | 0     | 0 | 242   |               |
| 4:15 PM                         | 6                            | 0    | 99    | 0 | 0                            | 0    | 0     | 0 | 0                         | 24   | 3     | 0 | 80                        | 34   | 0     | 0 | 246   |               |
| 4:20 PM                         | 2                            | 0    | 99    | 1 | 0                            | 0    | 0     | 0 | 0                         | 34   | 1     | 0 | 89                        | 41   | 0     | 0 | 267   |               |
| 4:25 PM                         | 0                            | 0    | 92    | 1 | 0                            | 0    | 0     | 0 | 0                         | 21   | 2     | 0 | 95                        | 35   | 0     | 0 | 246   |               |
| 4:30 PM                         | 6                            | 0    | 105   | 0 | 0                            | 0    | 0     | 0 | 0                         | 15   | 4     | 0 | 88                        | 33   | 0     | 0 | 251   |               |
| 4:35 PM                         | 1                            | 0    | 94    | 0 | 0                            | 0    | 0     | 0 | 0                         | 24   | 3     | 0 | 96                        | 34   | 0     | 0 | 252   |               |
| 4:40 PM                         | 3                            | 0    | 100   | 1 | 0                            | 0    | 0     | 0 | 0                         | 30   | 4     | 0 | 90                        | 42   | 0     | 0 | 270   |               |
| 4:45 PM                         | 3                            | 0    | 86    | 1 | 0                            | 0    | 0     | 0 | 0                         | 21   | 3     | 0 | 110                       | 45   | 0     | 1 | 270   |               |
| 4:50 PM                         | 3                            | 0    | 98    | 1 | 0                            | 0    | 0     | 0 | 0                         | 28   | 3     | 0 | 93                        | 37   | 0     | 0 | 263   |               |
| 4:55 PM                         | 2                            | 0    | 96    | 0 | 0                            | 0    | 0     | 0 | 0                         | 24   | 5     | 0 | 106                       | 31   | 0     | 0 | 264   | 3055          |
| 5:00 PM                         | 2                            | 0    | 98    | 0 | 0                            | 0    | 0     | 0 | 0                         | 16   | 4     | 0 | 97                        | 42   | 0     | 0 | 259   | 3072          |
| 5:05 PM                         | 4                            | 0    | 126   | 0 | 0                            | 0    | 0     | 0 | 0                         | 41   | 4     | 0 | 65                        | 33   | 0     | 0 | 273   | 3103          |
| 5:10 PM                         | 4                            | 0    | 114   | 0 | 0                            | 0    | 0     | 0 | 0                         | 20   | 0     | 0 | 101                       | 36   | 0     | 0 | 275   | 3136          |
| 5:15 PM                         | 2                            | 0    | 107   | 0 | 0                            | 0    | 0     | 0 | 0                         | 34   | 0     | 0 | 90                        | 33   | 0     | 0 | 266   | 3156          |
| 5:20 PM                         | 6                            | 0    | 112   | 0 | 0                            | 0    | 0     | 0 | 0                         | 27   | 0     | 0 | 89                        | 47   | 0     | 0 | 281   | 3170          |
| 5:25 PM                         | 3                            | 0    | 106   | 0 | 0                            | 0    | 0     | 0 | 0                         | 22   | 3     | 0 | 105                       | 50   | 0     | 0 | 289   | 3213          |
| 5:30 PM                         | 1                            | 0    | 100   | 0 | 0                            | 0    | 0     | 0 | 0                         | 19   | 1     | 0 | 98                        | 37   | 0     | 0 | 256   | 3218          |
| 5:35 PM                         | 2                            | 0    | 106   | 0 | 0                            | 0    | 0     | 0 | 0                         | 34   | 3     | 0 | 86                        | 24   | 0     | 0 | 255   | 3221          |
| 5:40 PM                         | 5                            | 0    | 88    | 0 | 0                            | 0    | 0     | 0 | 0                         | 32   | 1     | 0 | 95                        | 42   | 0     | 1 | 264   | 3215          |
| 5:45 PM                         | 1                            | 0    | 98    | 0 | 0                            | 0    | 0     | 0 | 0                         | 29   | 2     | 0 | 84                        | 38   | 0     | 0 | 252   | 3197          |
| 5:50 PM                         | 1                            | 0    | 85    | 0 | 0                            | 0    | 0     | 0 | 0                         | 15   | 2     | 0 | 113                       | 38   | 0     | 0 | 254   | 3188          |
| 5:55 PM                         | 0                            | 0    | 98    | 0 | 0                            | 0    | 0     | 0 | 0                         | 21   | 1     | 0 | 88                        | 44   | 0     | 0 | 252   | 3176          |
| Peak 15-Min Flowrates           | Northbound                   |      |       |   | Southbound                   |      |       |   | Eastbound                 |      |       |   | Westbound                 |      |       |   | Total |               |
|                                 | Left                         | Thru | Right | U | Left                         | Thru | Right | U | Left                      | Thru | Right | U | Left                      | Thru | Right | U |       |               |
| All Vehicles                    | 44                           | 0    | 1300  | 0 | 0                            | 0    | 0     | 0 | 0                         | 332  | 12    | 0 | 1136                      | 520  | 0     | 0 | 3344  |               |
| Heavy Trucks                    | 4                            | 0    | 12    |   | 0                            | 0    | 0     |   | 0                         | 8    | 0     |   | 8                         | 0    | 0     |   | 32    |               |
| Pedestrians                     |                              |      |       |   |                              |      |       |   |                           |      |       |   |                           |      |       |   | 0     |               |
| Bicycles                        | 0                            | 0    | 0     |   | 0                            | 0    | 0     |   | 0                         | 0    | 0     |   | 0                         | 0    | 0     |   | 0     |               |
| Railroad                        |                              |      |       |   |                              |      |       |   |                           |      |       |   |                           |      |       |   | 0     |               |
| Stopped Buses                   |                              |      |       |   |                              |      |       |   |                           |      |       |   |                           |      |       |   | 0     |               |

Comments:

**LOCATION:** 2. West Ln -- Eight Mile Rd  
**CITY/STATE:** Stockton, CA

**QC JOB #:** 14437903  
**DATE:** Thu, Jun 01 2017

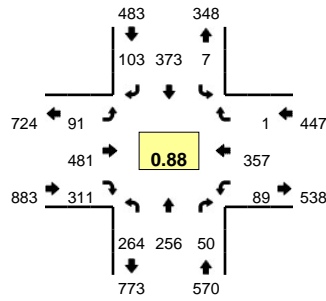

**Peak-Hour: 7:15 AM -- 8:15 AM**  
**Peak 15-Min: 7:40 AM -- 7:55 AM**

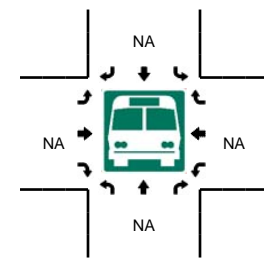
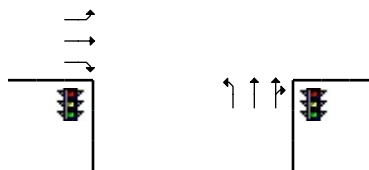
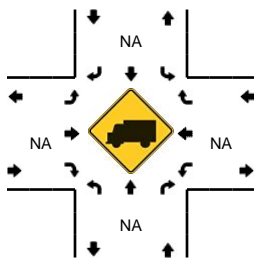
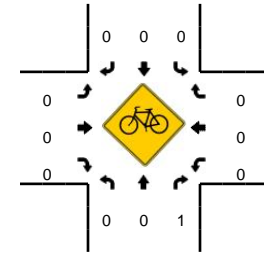
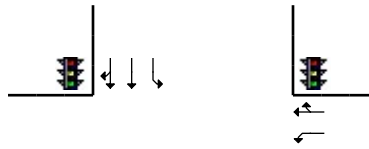
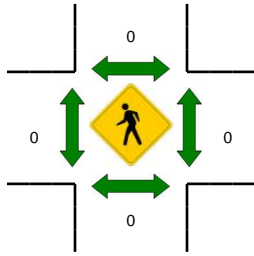
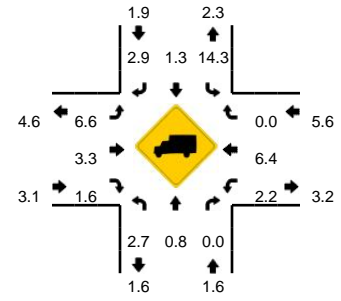

| 5-Min Count Period Beginning At | 2. West Ln (Northbound) |      |       |   | 2. West Ln (Southbound) |      |       |   | Eight Mile Rd (Eastbound) |      |       |   | Eight Mile Rd (Westbound) |      |       |   | Total | Hourly Totals |
|---------------------------------|-------------------------|------|-------|---|-------------------------|------|-------|---|---------------------------|------|-------|---|---------------------------|------|-------|---|-------|---------------|
|                                 | Left                    | Thru | Right | U | Left                    | Thru | Right | U | Left                      | Thru | Right | U | Left                      | Thru | Right | U |       |               |
| 7:00 AM                         | 20                      | 15   | 6     | 0 | 0                       | 13   | 6     | 0 | 8                         | 30   | 20    | 0 | 13                        | 30   | 1     | 0 | 162   |               |
| 7:05 AM                         | 6                       | 4    | 5     | 0 | 1                       | 30   | 4     | 0 | 7                         | 36   | 21    | 0 | 6                         | 28   | 0     | 0 | 148   |               |
| 7:10 AM                         | 7                       | 17   | 2     | 0 | 1                       | 19   | 5     | 0 | 7                         | 31   | 22    | 0 | 8                         | 19   | 1     | 0 | 139   |               |
| 7:15 AM                         | 16                      | 14   | 5     | 0 | 0                       | 21   | 7     | 0 | 10                        | 52   | 22    | 0 | 15                        | 35   | 0     | 0 | 197   |               |
| 7:20 AM                         | 19                      | 10   | 3     | 0 | 0                       | 29   | 7     | 0 | 10                        | 45   | 29    | 0 | 6                         | 20   | 0     | 0 | 178   |               |
| 7:25 AM                         | 20                      | 18   | 2     | 0 | 2                       | 41   | 16    | 0 | 7                         | 32   | 32    | 0 | 5                         | 14   | 0     | 0 | 189   |               |
| 7:30 AM                         | 19                      | 27   | 4     | 0 | 0                       | 22   | 5     | 0 | 7                         | 39   | 27    | 0 | 4                         | 37   | 0     | 0 | 191   |               |
| 7:35 AM                         | 23                      | 25   | 4     | 0 | 1                       | 41   | 14    | 0 | 7                         | 34   | 35    | 0 | 8                         | 23   | 0     | 0 | 215   |               |
| 7:40 AM                         | 19                      | 27   | 3     | 0 | 0                       | 43   | 7     | 0 | 8                         | 42   | 30    | 0 | 13                        | 23   | 0     | 0 | 215   |               |
| 7:45 AM                         | 27                      | 35   | 5     | 0 | 1                       | 27   | 6     | 0 | 9                         | 42   | 23    | 0 | 7                         | 30   | 0     | 0 | 212   |               |
| 7:50 AM                         | 26                      | 32   | 9     | 0 | 1                       | 48   | 8     | 0 | 4                         | 45   | 31    | 0 | 6                         | 41   | 0     | 0 | 251   |               |
| 7:55 AM                         | 24                      | 18   | 6     | 0 | 0                       | 29   | 8     | 0 | 6                         | 46   | 23    | 0 | 5                         | 39   | 0     | 0 | 204   | 2301          |
| 8:00 AM                         | 21                      | 20   | 3     | 0 | 0                       | 16   | 9     | 0 | 7                         | 49   | 25    | 0 | 5                         | 42   | 0     | 0 | 197   | 2336          |
| 8:05 AM                         | 30                      | 17   | 4     | 0 | 1                       | 29   | 10    | 0 | 2                         | 24   | 14    | 0 | 6                         | 31   | 1     | 0 | 169   | 2357          |
| 8:10 AM                         | 20                      | 13   | 2     | 0 | 1                       | 27   | 6     | 0 | 14                        | 31   | 20    | 0 | 9                         | 22   | 0     | 0 | 165   | 2383          |
| 8:15 AM                         | 21                      | 22   | 6     | 0 | 0                       | 26   | 3     | 1 | 11                        | 31   | 20    | 0 | 2                         | 30   | 0     | 0 | 173   | 2359          |
| 8:20 AM                         | 19                      | 23   | 4     | 0 | 0                       | 26   | 8     | 0 | 5                         | 36   | 27    | 0 | 4                         | 35   | 0     | 0 | 187   | 2368          |
| 8:25 AM                         | 12                      | 15   | 3     | 0 | 0                       | 40   | 11    | 0 | 10                        | 37   | 18    | 0 | 2                         | 18   | 0     | 0 | 166   | 2345          |
| 8:30 AM                         | 19                      | 15   | 8     | 0 | 1                       | 30   | 11    | 0 | 4                         | 27   | 21    | 0 | 3                         | 13   | 2     | 0 | 154   | 2308          |
| 8:35 AM                         | 18                      | 15   | 5     | 0 | 1                       | 20   | 4     | 1 | 10                        | 41   | 21    | 0 | 3                         | 31   | 1     | 0 | 171   | 2264          |
| 8:40 AM                         | 23                      | 29   | 2     | 0 | 0                       | 28   | 12    | 0 | 8                         | 19   | 17    | 0 | 5                         | 16   | 1     | 0 | 160   | 2209          |
| 8:45 AM                         | 23                      | 32   | 4     | 0 | 2                       | 11   | 5     | 0 | 13                        | 31   | 24    | 0 | 7                         | 23   | 2     | 0 | 177   | 2174          |
| 8:50 AM                         | 13                      | 35   | 4     | 0 | 2                       | 26   | 4     | 0 | 12                        | 23   | 29    | 0 | 7                         | 30   | 0     | 0 | 185   | 2108          |
| 8:55 AM                         | 25                      | 26   | 6     | 0 | 0                       | 23   | 4     | 0 | 7                         | 30   | 25    | 0 | 3                         | 20   | 0     | 0 | 169   | 2073          |
| Peak 15-Min Flowrates           | Northbound              |      |       |   | Southbound              |      |       |   | Eastbound                 |      |       |   | Westbound                 |      |       |   | Total |               |
|                                 | Left                    | Thru | Right | U | Left                    | Thru | Right | U | Left                      | Thru | Right | U | Left                      | Thru | Right | U |       |               |
| All Vehicles                    | 288                     | 376  | 68    | 0 | 8                       | 472  | 84    | 0 | 84                        | 516  | 336   | 0 | 104                       | 376  | 0     | 0 | 2712  |               |
| Heavy Trucks                    | 4                       | 4    | 0     | 0 | 0                       | 4    | 0     | 0 | 8                         | 16   | 4     | 0 | 0                         | 16   | 0     | 0 | 56    |               |
| Pedestrians                     | 0                       | 0    | 0     | 0 | 0                       | 0    | 0     | 0 | 0                         | 0    | 0     | 0 | 0                         | 0    | 0     | 0 | 0     |               |
| Bicycles                        | 0                       | 0    | 1     | 0 | 0                       | 0    | 0     | 0 | 0                         | 0    | 0     | 0 | 0                         | 0    | 0     | 0 | 1     |               |
| Railroad                        |                         |      |       |   |                         |      |       |   |                           |      |       |   |                           |      |       |   |       |               |
| Stopped Buses                   |                         |      |       |   |                         |      |       |   |                           |      |       |   |                           |      |       |   |       |               |

Comments:

**LOCATION:** 2.Eight Mile Road -- West Lane  
**CITY/STATE:** Stockton, CA

**QC JOB #:** 14437904  
**DATE:** Thu, Jun 01 2017

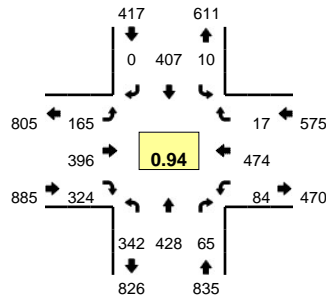

**Peak-Hour: 5:00 PM -- 6:00 PM**  
**Peak 15-Min: 5:05 PM -- 5:20 PM**

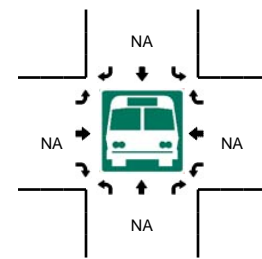
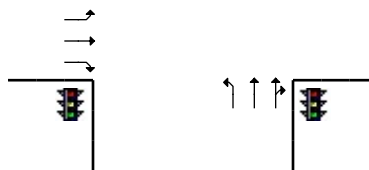
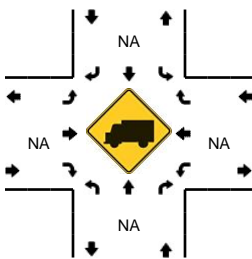
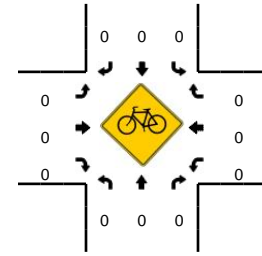
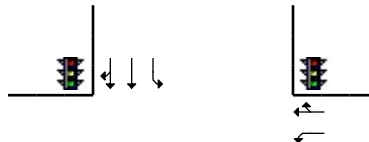
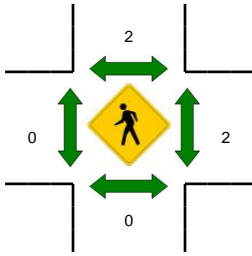
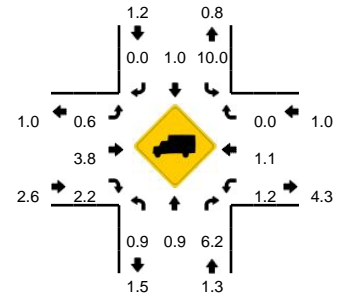

| 5-Min Count Period Beginning At | 2.Eight Mile Road (Northbound) |      |       |   | 2.Eight Mile Road (Southbound) |      |       |   | West Lane (Eastbound) |      |       |   | West Lane (Westbound) |      |       |   | Total | Hourly Totals |
|---------------------------------|--------------------------------|------|-------|---|--------------------------------|------|-------|---|-----------------------|------|-------|---|-----------------------|------|-------|---|-------|---------------|
|                                 | Left                           | Thru | Right | U | Left                           | Thru | Right | U | Left                  | Thru | Right | U | Left                  | Thru | Right | U |       |               |
| 4:00 PM                         | 18                             | 21   | 4     | 0 | 0                              | 11   | 0     | 0 | 18                    | 34   | 25    | 0 | 10                    | 28   | 1     | 0 | 170   |               |
| 4:05 PM                         | 20                             | 36   | 7     | 0 | 0                              | 27   | 0     | 0 | 9                     | 19   | 17    | 0 | 2                     | 31   | 0     | 0 | 168   |               |
| 4:10 PM                         | 21                             | 26   | 6     | 1 | 1                              | 24   | 0     | 0 | 12                    | 35   | 23    | 0 | 6                     | 45   | 1     | 0 | 201   |               |
| 4:15 PM                         | 29                             | 34   | 6     | 0 | 2                              | 20   | 0     | 2 | 10                    | 31   | 30    | 0 | 2                     | 41   | 0     | 0 | 207   |               |
| 4:20 PM                         | 21                             | 39   | 7     | 0 | 0                              | 31   | 1     | 1 | 10                    | 24   | 28    | 0 | 4                     | 25   | 0     | 0 | 191   |               |
| 4:25 PM                         | 25                             | 30   | 3     | 0 | 0                              | 27   | 0     | 1 | 15                    | 24   | 25    | 0 | 7                     | 38   | 0     | 0 | 195   |               |
| 4:30 PM                         | 30                             | 26   | 0     | 0 | 1                              | 27   | 0     | 0 | 13                    | 33   | 23    | 0 | 7                     | 40   | 1     | 0 | 201   |               |
| 4:35 PM                         | 30                             | 38   | 8     | 0 | 0                              | 21   | 0     | 0 | 17                    | 34   | 25    | 0 | 8                     | 36   | 1     | 0 | 218   |               |
| 4:40 PM                         | 32                             | 43   | 6     | 0 | 0                              | 44   | 0     | 0 | 8                     | 50   | 19    | 0 | 3                     | 38   | 3     | 0 | 246   |               |
| 4:45 PM                         | 28                             | 31   | 5     | 0 | 1                              | 35   | 0     | 0 | 12                    | 31   | 30    | 0 | 3                     | 37   | 9     | 0 | 222   |               |
| 4:50 PM                         | 21                             | 34   | 2     | 0 | 1                              | 20   | 0     | 1 | 12                    | 36   | 25    | 0 | 2                     | 38   | 3     | 0 | 195   |               |
| 4:55 PM                         | 17                             | 24   | 6     | 0 | 1                              | 27   | 0     | 0 | 4                     | 30   | 28    | 0 | 4                     | 46   | 1     | 0 | 188   | 2402          |
| 5:00 PM                         | 39                             | 45   | 12    | 0 | 1                              | 30   | 0     | 0 | 10                    | 23   | 19    | 0 | 9                     | 20   | 2     | 0 | 210   | 2442          |
| 5:05 PM                         | 28                             | 24   | 1     | 0 | 1                              | 30   | 0     | 0 | 8                     | 44   | 29    | 0 | 11                    | 54   | 0     | 0 | 230   | 2504          |
| 5:10 PM                         | 33                             | 45   | 8     | 0 | 0                              | 36   | 0     | 0 | 17                    | 29   | 34    | 0 | 7                     | 36   | 4     | 0 | 249   | 2552          |
| 5:15 PM                         | 31                             | 33   | 7     | 1 | 2                              | 55   | 0     | 0 | 14                    | 38   | 24    | 0 | 4                     | 31   | 0     | 0 | 240   | 2585          |
| 5:20 PM                         | 31                             | 32   | 1     | 0 | 1                              | 21   | 0     | 0 | 9                     | 27   | 28    | 0 | 9                     | 49   | 4     | 0 | 212   | 2606          |
| 5:25 PM                         | 17                             | 34   | 5     | 0 | 0                              | 35   | 0     | 0 | 19                    | 39   | 32    | 0 | 10                    | 52   | 1     | 0 | 244   | 2655          |
| 5:30 PM                         | 26                             | 36   | 11    | 1 | 0                              | 36   | 0     | 1 | 15                    | 30   | 20    | 0 | 8                     | 26   | 0     | 0 | 210   | 2664          |
| 5:35 PM                         | 32                             | 32   | 4     | 0 | 0                              | 39   | 0     | 0 | 16                    | 38   | 28    | 0 | 0                     | 28   | 1     | 0 | 218   | 2664          |
| 5:40 PM                         | 18                             | 50   | 8     | 2 | 2                              | 40   | 0     | 0 | 10                    | 20   | 28    | 0 | 3                     | 47   | 2     | 0 | 230   | 2648          |
| 5:45 PM                         | 27                             | 35   | 3     | 4 | 1                              | 23   | 0     | 0 | 15                    | 30   | 28    | 0 | 5                     | 47   | 2     | 0 | 220   | 2646          |
| 5:50 PM                         | 22                             | 22   | 4     | 2 | 1                              | 26   | 0     | 0 | 19                    | 32   | 28    | 0 | 9                     | 46   | 1     | 0 | 212   | 2663          |
| 5:55 PM                         | 27                             | 40   | 1     | 1 | 0                              | 36   | 0     | 0 | 13                    | 46   | 26    | 0 | 9                     | 38   | 0     | 0 | 237   | 2712          |
| Peak 15-Min Flowrates           | Northbound                     |      |       |   | Southbound                     |      |       |   | Eastbound             |      |       |   | Westbound             |      |       |   | Total |               |
|                                 | Left                           | Thru | Right | U | Left                           | Thru | Right | U | Left                  | Thru | Right | U | Left                  | Thru | Right | U |       |               |
| All Vehicles                    | 368                            | 408  | 64    | 4 | 12                             | 484  | 0     | 0 | 156                   | 444  | 348   | 0 | 88                    | 484  | 16    | 0 | 2876  |               |
| Heavy Trucks                    | 8                              | 8    | 4     |   | 4                              | 0    | 0     |   | 0                     | 4    | 8     |   | 0                     | 8    | 0     |   | 44    |               |
| Pedestrians                     |                                | 0    |       |   |                                | 0    |       |   |                       | 0    |       |   |                       | 0    |       |   | 0     |               |
| Bicycles                        | 0                              | 0    | 0     |   | 0                              | 0    | 0     |   | 0                     | 0    | 0     |   | 0                     | 0    | 0     |   | 0     |               |
| Railroad                        |                                |      |       |   |                                |      |       |   |                       |      |       |   |                       |      |       |   |       |               |
| Stopped Buses                   |                                |      |       |   |                                |      |       |   |                       |      |       |   |                       |      |       |   |       |               |

Comments:

**LOCATION:** 3. West Ln -- Hammer Ln  
**CITY/STATE:** Stockton, CA

**QC JOB #:** 14437905  
**DATE:** Thu, Jun 01 2017

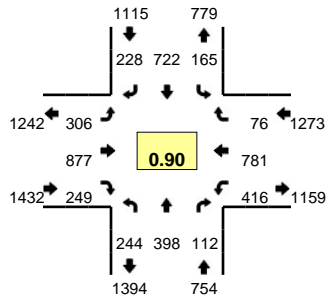

**Peak-Hour: 7:35 AM -- 8:35 AM**  
**Peak 15-Min: 7:45 AM -- 8:00 AM**

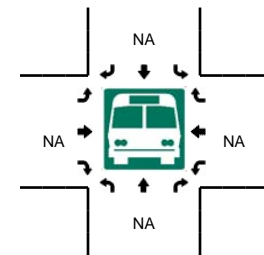
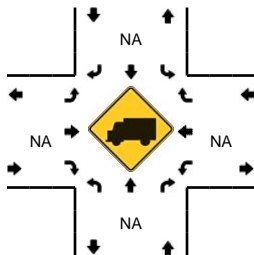
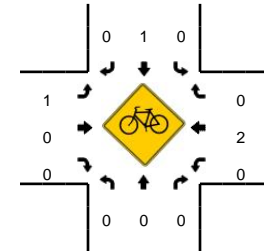
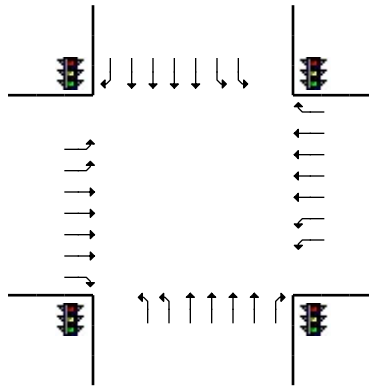
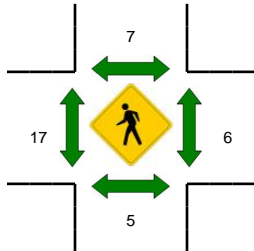
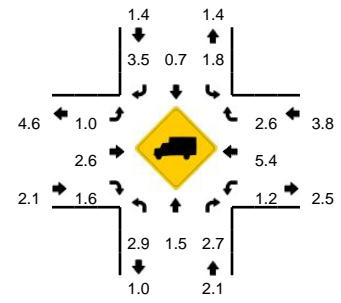

| 5-Min Count Period Beginning At | 3. West Ln (Northbound) |      |       |    | 3. West Ln (Southbound) |      |       |   | Hammer Ln (Eastbound) |      |       |   | Hammer Ln (Westbound) |      |       |    | Total | Hourly Totals |
|---------------------------------|-------------------------|------|-------|----|-------------------------|------|-------|---|-----------------------|------|-------|---|-----------------------|------|-------|----|-------|---------------|
|                                 | Left                    | Thru | Right | U  | Left                    | Thru | Right | U | Left                  | Thru | Right | U | Left                  | Thru | Right | U  |       |               |
| 7:00 AM                         | 24                      | 19   | 5     | 0  | 11                      | 28   | 6     | 0 | 14                    | 76   | 9     | 0 | 17                    | 49   | 9     | 0  | 267   |               |
| 7:05 AM                         | 10                      | 29   | 10    | 0  | 8                       | 34   | 11    | 0 | 9                     | 51   | 23    | 0 | 17                    | 45   | 13    | 0  | 260   |               |
| 7:10 AM                         | 11                      | 23   | 10    | 2  | 10                      | 50   | 15    | 0 | 6                     | 64   | 17    | 0 | 11                    | 63   | 6     | 0  | 288   |               |
| 7:15 AM                         | 11                      | 20   | 8     | 0  | 8                       | 29   | 16    | 0 | 16                    | 89   | 12    | 1 | 17                    | 62   | 9     | 1  | 299   |               |
| 7:20 AM                         | 26                      | 25   | 6     | 0  | 18                      | 44   | 18    | 1 | 21                    | 45   | 17    | 0 | 21                    | 40   | 6     | 0  | 288   |               |
| 7:25 AM                         | 10                      | 29   | 4     | 0  | 15                      | 56   | 13    | 1 | 13                    | 80   | 27    | 1 | 14                    | 66   | 4     | 0  | 333   |               |
| 7:30 AM                         | 11                      | 32   | 9     | 2  | 9                       | 43   | 20    | 1 | 28                    | 62   | 24    | 1 | 20                    | 31   | 3     | 2  | 298   |               |
| 7:35 AM                         | 12                      | 32   | 6     | 2  | 13                      | 51   | 24    | 3 | 22                    | 87   | 18    | 1 | 29                    | 76   | 11    | 0  | 387   |               |
| 7:40 AM                         | 20                      | 37   | 10    | 2  | 19                      | 57   | 18    | 1 | 29                    | 61   | 25    | 1 | 19                    | 64   | 4     | 0  | 367   |               |
| 7:45 AM                         | 13                      | 35   | 5     | 1  | 8                       | 62   | 22    | 0 | 24                    | 82   | 32    | 1 | 48                    | 99   | 6     | 1  | 439   |               |
| 7:50 AM                         | 20                      | 33   | 10    | 2  | 9                       | 95   | 20    | 0 | 25                    | 51   | 12    | 0 | 45                    | 62   | 3     | 2  | 389   |               |
| 7:55 AM                         | 19                      | 29   | 7     | 2  | 13                      | 63   | 22    | 0 | 27                    | 110  | 26    | 0 | 40                    | 75   | 5     | 4  | 442   | 4057          |
| 8:00 AM                         | 35                      | 49   | 5     | 1  | 9                       | 64   | 16    | 2 | 21                    | 74   | 21    | 0 | 14                    | 55   | 6     | 0  | 372   | 4162          |
| 8:05 AM                         | 14                      | 30   | 11    | 2  | 10                      | 30   | 13    | 1 | 31                    | 56   | 21    | 1 | 38                    | 50   | 9     | 6  | 323   | 4225          |
| 8:10 AM                         | 16                      | 38   | 13    | 2  | 12                      | 61   | 17    | 0 | 12                    | 60   | 23    | 2 | 17                    | 56   | 9     | 0  | 338   | 4275          |
| 8:15 AM                         | 22                      | 24   | 14    | 3  | 12                      | 53   | 22    | 1 | 30                    | 69   | 18    | 3 | 46                    | 71   | 5     | 0  | 393   | 4369          |
| 8:20 AM                         | 20                      | 33   | 14    | 1  | 16                      | 62   | 20    | 0 | 31                    | 63   | 20    | 0 | 48                    | 33   | 6     | 0  | 367   | 4448          |
| 8:25 AM                         | 19                      | 24   | 7     | 3  | 20                      | 59   | 24    | 2 | 13                    | 88   | 17    | 0 | 21                    | 62   | 7     | 0  | 366   | 4481          |
| 8:30 AM                         | 12                      | 34   | 10    | 1  | 14                      | 65   | 10    | 0 | 30                    | 76   | 16    | 2 | 36                    | 78   | 5     | 2  | 391   | 4574          |
| 8:35 AM                         | 23                      | 29   | 11    | 1  | 12                      | 59   | 19    | 0 | 15                    | 80   | 27    | 1 | 39                    | 40   | 6     | 0  | 362   | 4549          |
| 8:40 AM                         | 8                       | 22   | 11    | 1  | 14                      | 51   | 9     | 0 | 28                    | 78   | 22    | 1 | 36                    | 90   | 8     | 0  | 379   | 4561          |
| 8:45 AM                         | 26                      | 33   | 9     | 1  | 17                      | 66   | 17    | 0 | 23                    | 46   | 15    | 0 | 30                    | 34   | 6     | 2  | 325   | 4447          |
| 8:50 AM                         | 16                      | 21   | 14    | 4  | 6                       | 38   | 13    | 2 | 24                    | 91   | 19    | 0 | 38                    | 96   | 8     | 3  | 393   | 4451          |
| 8:55 AM                         | 22                      | 42   | 14    | 3  | 15                      | 68   | 24    | 0 | 18                    | 68   | 16    | 0 | 13                    | 50   | 9     | 1  | 363   | 4372          |
| Peak 15-Min Flowrates           | Northbound              |      |       |    | Southbound              |      |       |   | Eastbound             |      |       |   | Westbound             |      |       |    | Total |               |
|                                 | Left                    | Thru | Right | U  | Left                    | Thru | Right | U | Left                  | Thru | Right | U | Left                  | Thru | Right | U  |       |               |
| All Vehicles                    | 208                     | 388  | 88    | 20 | 120                     | 880  | 256   | 0 | 304                   | 972  | 280   | 4 | 532                   | 944  | 56    | 28 | 5080  |               |
| Heavy Trucks                    | 12                      | 4    | 0     |    | 0                       | 8    | 4     |   | 0                     | 24   | 8     |   | 0                     | 52   | 0     |    | 112   |               |
| Pedestrians                     |                         | 4    |       |    |                         | 8    |       |   |                       | 24   |       |   |                       | 8    |       |    | 44    |               |
| Bicycles                        | 0                       | 0    | 0     |    | 0                       | 0    | 0     |   | 0                     | 0    | 0     |   | 0                     | 2    | 0     |    | 2     |               |
| Railroad                        |                         |      |       |    |                         |      |       |   |                       |      |       |   |                       |      |       |    |       |               |
| Stopped Buses                   |                         |      |       |    |                         |      |       |   |                       |      |       |   |                       |      |       |    |       |               |

Comments:

**LOCATION:** 3. West Ln -- Hammer Ln  
**CITY/STATE:** Stockton, CA

**QC JOB #:** 14437906  
**DATE:** Thu, Jun 01 2017

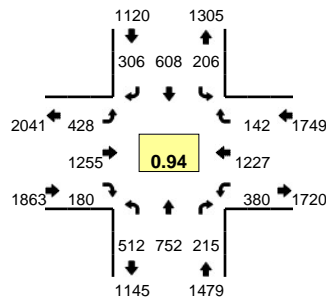

**Peak-Hour: 5:00 PM -- 6:00 PM**  
**Peak 15-Min: 5:15 PM -- 5:30 PM**

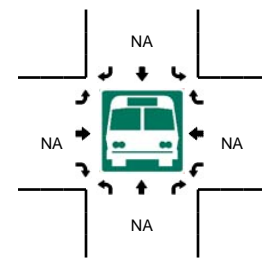
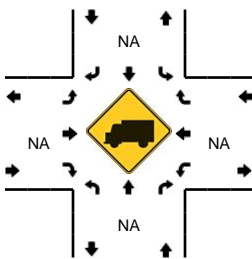
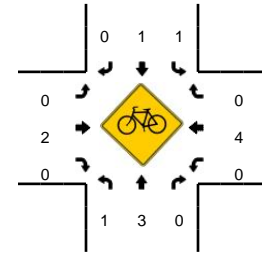
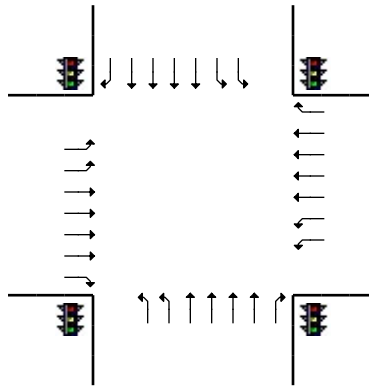
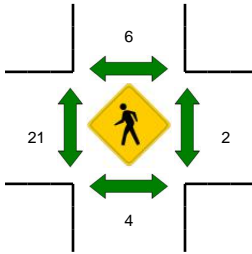
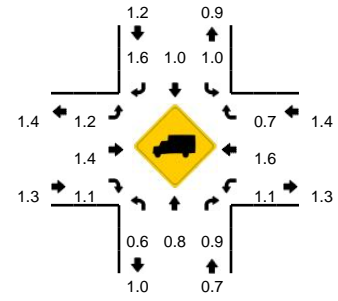

| 5-Min Count Period Beginning At | 3. West Ln (Northbound) |      |       |    | 3. West Ln (Southbound) |      |       |    | Hammer Ln (Eastbound) |      |       |    | Hammer Ln (Westbound) |      |       |    | Total | Hourly Totals |
|---------------------------------|-------------------------|------|-------|----|-------------------------|------|-------|----|-----------------------|------|-------|----|-----------------------|------|-------|----|-------|---------------|
|                                 | Left                    | Thru | Right | U  | Left                    | Thru | Right | U  | Left                  | Thru | Right | U  | Left                  | Thru | Right | U  |       |               |
| 4:00 PM                         | 48                      | 43   | 12    | 4  | 22                      | 27   | 10    | 0  | 26                    | 99   | 13    | 2  | 32                    | 120  | 10    | 3  | 471   |               |
| 4:05 PM                         | 31                      | 78   | 19    | 1  | 28                      | 33   | 20    | 0  | 15                    | 90   | 12    | 2  | 41                    | 86   | 19    | 1  | 476   |               |
| 4:10 PM                         | 40                      | 47   | 25    | 2  | 13                      | 53   | 18    | 1  | 38                    | 85   | 14    | 1  | 12                    | 64   | 15    | 1  | 429   |               |
| 4:15 PM                         | 43                      | 60   | 13    | 1  | 16                      | 46   | 15    | 0  | 34                    | 106  | 14    | 1  | 32                    | 105  | 11    | 5  | 502   |               |
| 4:20 PM                         | 35                      | 40   | 9     | 5  | 18                      | 34   | 21    | 0  | 23                    | 139  | 19    | 1  | 31                    | 97   | 11    | 8  | 491   |               |
| 4:25 PM                         | 53                      | 65   | 16    | 4  | 14                      | 39   | 13    | 1  | 26                    | 97   | 19    | 1  | 24                    | 129  | 10    | 4  | 515   |               |
| 4:30 PM                         | 27                      | 74   | 17    | 3  | 29                      | 43   | 15    | 1  | 37                    | 89   | 8     | 2  | 35                    | 75   | 13    | 4  | 472   |               |
| 4:35 PM                         | 31                      | 53   | 15    | 2  | 16                      | 50   | 17    | 0  | 40                    | 103  | 12    | 1  | 23                    | 79   | 11    | 3  | 456   |               |
| 4:40 PM                         | 36                      | 68   | 15    | 2  | 10                      | 38   | 16    | 1  | 24                    | 121  | 17    | 3  | 33                    | 93   | 11    | 7  | 495   |               |
| 4:45 PM                         | 53                      | 77   | 20    | 6  | 25                      | 39   | 18    | 0  | 25                    | 93   | 10    | 3  | 21                    | 105  | 11    | 4  | 510   |               |
| 4:50 PM                         | 28                      | 57   | 22    | 1  | 18                      | 60   | 11    | 0  | 43                    | 99   | 15    | 2  | 13                    | 85   | 11    | 4  | 469   |               |
| 4:55 PM                         | 38                      | 54   | 19    | 2  | 17                      | 40   | 17    | 1  | 38                    | 120  | 18    | 2  | 25                    | 66   | 17    | 9  | 483   | 5769          |
| 5:00 PM                         | 29                      | 55   | 14    | 2  | 14                      | 47   | 12    | 0  | 24                    | 98   | 13    | 2  | 22                    | 120  | 12    | 8  | 472   | 5770          |
| 5:05 PM                         | 42                      | 70   | 14    | 1  | 12                      | 37   | 18    | 1  | 33                    | 117  | 10    | 5  | 21                    | 82   | 15    | 4  | 482   | 5776          |
| 5:10 PM                         | 46                      | 80   | 22    | 1  | 22                      | 57   | 25    | 0  | 32                    | 106  | 12    | 2  | 26                    | 110  | 17    | 0  | 558   | 5905          |
| 5:15 PM                         | 42                      | 54   | 17    | 3  | 13                      | 52   | 22    | 0  | 14                    | 135  | 9     | 1  | 35                    | 110  | 6     | 0  | 513   | 5916          |
| 5:20 PM                         | 45                      | 73   | 25    | 1  | 18                      | 76   | 36    | 1  | 40                    | 94   | 13    | 2  | 21                    | 88   | 13    | 4  | 550   | 5975          |
| 5:25 PM                         | 43                      | 60   | 15    | 4  | 21                      | 71   | 35    | 3  | 54                    | 109  | 14    | 2  | 28                    | 116  | 14    | 7  | 596   | 6056          |
| 5:30 PM                         | 40                      | 55   | 17    | 5  | 10                      | 47   | 32    | 1  | 28                    | 110  | 15    | 1  | 31                    | 94   | 11    | 7  | 504   | 6088          |
| 5:35 PM                         | 55                      | 79   | 26    | 4  | 19                      | 33   | 28    | 0  | 33                    | 81   | 17    | 2  | 26                    | 112  | 18    | 6  | 539   | 6171          |
| 5:40 PM                         | 41                      | 71   | 19    | 2  | 19                      | 48   | 34    | 1  | 42                    | 97   | 13    | 3  | 23                    | 89   | 11    | 1  | 514   | 6190          |
| 5:45 PM                         | 34                      | 58   | 15    | 0  | 14                      | 52   | 23    | 0  | 44                    | 103  | 24    | 0  | 35                    | 84   | 7     | 4  | 497   | 6177          |
| 5:50 PM                         | 24                      | 45   | 19    | 0  | 27                      | 41   | 14    | 1  | 29                    | 121  | 18    | 2  | 34                    | 81   | 9     | 7  | 472   | 6180          |
| 5:55 PM                         | 42                      | 52   | 12    | 6  | 9                       | 47   | 27    | 0  | 30                    | 84   | 22    | 3  | 26                    | 141  | 9     | 4  | 514   | 6211          |
| Peak 15-Min Flowrates           | Northbound              |      |       |    | Southbound              |      |       |    | Eastbound             |      |       |    | Westbound             |      |       |    | Total |               |
|                                 | Left                    | Thru | Right | U  | Left                    | Thru | Right | U  | Left                  | Thru | Right | U  | Left                  | Thru | Right | U  |       |               |
| All Vehicles                    | 520                     | 748  | 228   | 32 | 208                     | 796  | 372   | 16 | 432                   | 1352 | 144   | 20 | 336                   | 1256 | 132   | 44 | 6636  |               |
| Heavy Trucks                    | 4                       | 4    | 0     |    | 0                       | 12   | 12    |    | 8                     | 16   | 4     |    | 8                     | 8    | 0     |    | 76    |               |
| Pedestrians                     |                         | 4    |       |    |                         | 4    |       |    |                       | 16   |       |    |                       | 0    |       |    | 24    |               |
| Bicycles                        | 0                       | 1    | 0     |    | 0                       | 0    | 0     |    | 0                     | 0    | 0     |    | 0                     | 1    | 0     |    | 2     |               |
| Railroad                        |                         |      |       |    |                         |      |       |    |                       |      |       |    |                       |      |       |    |       |               |
| Stopped Buses                   |                         |      |       |    |                         |      |       |    |                       |      |       |    |                       |      |       |    |       |               |

Comments:



**LOCATION:** 4. Hammer Lane -- Holman Road  
**CITY/STATE:** Stockton, CA

**QC JOB #:** 14437907  
**DATE:** Thu, Jun 01 2017

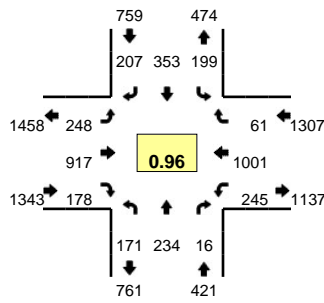

**Peak-Hour: 7:30 AM -- 8:30 AM**  
**Peak 15-Min: 7:40 AM -- 7:55 AM**

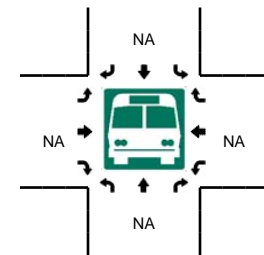
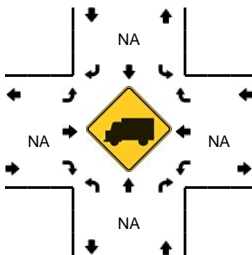
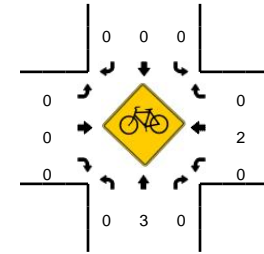
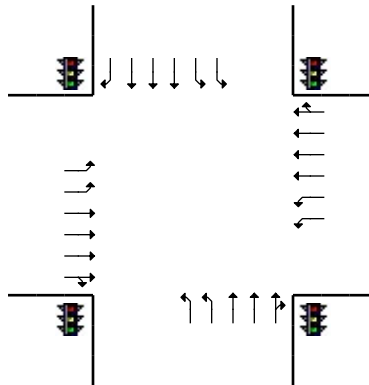
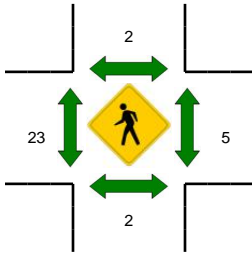
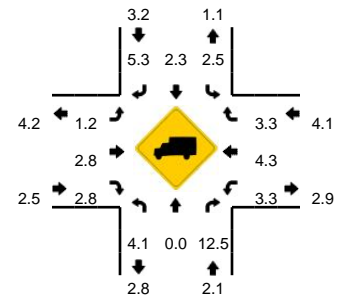

| 5-Min Count Period Beginning At | 4. Hammer Lane (Northbound) |      |       |    | 4. Hammer Lane (Southbound) |      |       |    | Holman Road (Eastbound) |      |       |    | Holman Road (Westbound) |      |       |    | Total | Hourly Totals |
|---------------------------------|-----------------------------|------|-------|----|-----------------------------|------|-------|----|-------------------------|------|-------|----|-------------------------|------|-------|----|-------|---------------|
|                                 | Left                        | Thru | Right | U  | Left                        | Thru | Right | U  | Left                    | Thru | Right | U  | Left                    | Thru | Right | U  |       |               |
| 7:00 AM                         | 18                          | 9    | 3     | 0  | 15                          | 26   | 12    | 2  | 4                       | 51   | 36    | 4  | 18                      | 39   | 2     | 0  | 239   |               |
| 7:05 AM                         | 30                          | 9    | 1     | 0  | 12                          | 22   | 12    | 0  | 10                      | 67   | 22    | 7  | 15                      | 51   | 5     | 1  | 264   |               |
| 7:10 AM                         | 28                          | 13   | 1     | 0  | 13                          | 18   | 15    | 0  | 4                       | 60   | 34    | 2  | 13                      | 42   | 6     | 0  | 249   |               |
| 7:15 AM                         | 19                          | 14   | 1     | 1  | 9                           | 12   | 10    | 1  | 10                      | 74   | 31    | 7  | 20                      | 65   | 4     | 0  | 278   |               |
| 7:20 AM                         | 22                          | 13   | 1     | 0  | 8                           | 25   | 9     | 0  | 7                       | 73   | 21    | 8  | 14                      | 70   | 2     | 1  | 274   |               |
| 7:25 AM                         | 18                          | 23   | 4     | 1  | 14                          | 33   | 6     | 0  | 17                      | 57   | 25    | 10 | 22                      | 51   | 9     | 1  | 291   |               |
| 7:30 AM                         | 15                          | 21   | 0     | 0  | 13                          | 23   | 12    | 0  | 10                      | 75   | 13    | 5  | 16                      | 82   | 13    | 0  | 298   |               |
| 7:35 AM                         | 13                          | 20   | 1     | 0  | 16                          | 23   | 11    | 1  | 10                      | 104  | 18    | 5  | 18                      | 95   | 2     | 0  | 337   |               |
| 7:40 AM                         | 10                          | 18   | 2     | 1  | 11                          | 28   | 32    | 4  | 13                      | 80   | 13    | 6  | 24                      | 87   | 6     | 5  | 340   |               |
| 7:45 AM                         | 19                          | 19   | 0     | 1  | 16                          | 31   | 27    | 1  | 9                       | 62   | 6     | 7  | 20                      | 69   | 1     | 3  | 291   |               |
| 7:50 AM                         | 12                          | 15   | 1     | 1  | 24                          | 30   | 18    | 2  | 10                      | 99   | 22    | 7  | 17                      | 102  | 3     | 2  | 365   |               |
| 7:55 AM                         | 9                           | 26   | 1     | 1  | 10                          | 37   | 16    | 0  | 20                      | 72   | 22    | 4  | 23                      | 90   | 3     | 4  | 338   | 3564          |
| 8:00 AM                         | 14                          | 11   | 1     | 0  | 13                          | 22   | 18    | 1  | 14                      | 56   | 19    | 6  | 17                      | 63   | 4     | 2  | 261   | 3586          |
| 8:05 AM                         | 13                          | 21   | 1     | 1  | 17                          | 33   | 11    | 2  | 12                      | 81   | 13    | 6  | 24                      | 98   | 3     | 1  | 337   | 3659          |
| 8:10 AM                         | 11                          | 18   | 3     | 1  | 11                          | 27   | 20    | 1  | 12                      | 80   | 17    | 8  | 20                      | 107  | 8     | 1  | 345   | 3755          |
| 8:15 AM                         | 14                          | 24   | 2     | 0  | 17                          | 30   | 14    | 0  | 14                      | 63   | 13    | 11 | 18                      | 61   | 4     | 0  | 285   | 3762          |
| 8:20 AM                         | 15                          | 23   | 3     | 0  | 20                          | 39   | 14    | 1  | 24                      | 70   | 13    | 8  | 16                      | 48   | 7     | 2  | 303   | 3791          |
| 8:25 AM                         | 20                          | 18   | 1     | 0  | 15                          | 30   | 14    | 3  | 15                      | 75   | 9     | 12 | 11                      | 99   | 7     | 1  | 330   | 3830          |
| 8:30 AM                         | 12                          | 16   | 3     | 0  | 11                          | 21   | 19    | 1  | 12                      | 65   | 10    | 16 | 20                      | 81   | 6     | 3  | 296   | 3828          |
| 8:35 AM                         | 22                          | 21   | 0     | 0  | 23                          | 30   | 17    | 0  | 14                      | 74   | 12    | 14 | 17                      | 83   | 1     | 7  | 335   | 3826          |
| 8:40 AM                         | 19                          | 10   | 0     | 0  | 13                          | 32   | 18    | 2  | 19                      | 60   | 14    | 9  | 27                      | 55   | 7     | 0  | 285   | 3771          |
| 8:45 AM                         | 21                          | 15   | 1     | 1  | 9                           | 24   | 16    | 0  | 12                      | 73   | 18    | 8  | 18                      | 87   | 5     | 1  | 309   | 3789          |
| 8:50 AM                         | 11                          | 25   | 4     | 0  | 14                          | 23   | 12    | 0  | 14                      | 47   | 11    | 11 | 17                      | 73   | 6     | 2  | 270   | 3694          |
| 8:55 AM                         | 24                          | 21   | 1     | 1  | 22                          | 18   | 14    | 0  | 6                       | 47   | 14    | 6  | 17                      | 50   | 3     | 1  | 245   | 3601          |
| Peak 15-Min Flowrates           | Northbound                  |      |       |    | Southbound                  |      |       |    | Eastbound               |      |       |    | Westbound               |      |       |    | Total |               |
|                                 | Left                        | Thru | Right | U  | Left                        | Thru | Right | U  | Left                    | Thru | Right | U  | Left                    | Thru | Right | U  |       |               |
| All Vehicles                    | 164                         | 208  | 12    | 12 | 204                         | 356  | 308   | 28 | 128                     | 964  | 164   | 80 | 244                     | 1032 | 40    | 40 | 3984  |               |
| Heavy Trucks                    | 12                          | 0    | 0     |    | 8                           | 16   | 24    |    | 0                       | 36   | 0     |    | 4                       | 24   | 4     |    | 128   |               |
| Pedestrians                     |                             | 0    |       |    |                             | 4    |       |    |                         | 4    |       |    |                         | 4    |       |    | 12    |               |
| Bicycles                        | 0                           | 2    | 0     |    | 0                           | 0    | 0     |    | 0                       | 0    | 0     |    | 0                       | 0    | 0     |    | 2     |               |
| Railroad                        |                             |      |       |    |                             |      |       |    |                         |      |       |    |                         |      |       |    |       |               |
| Stopped Buses                   |                             |      |       |    |                             |      |       |    |                         |      |       |    |                         |      |       |    |       |               |

Comments:

**LOCATION:** 4. Hammer Lane -- Holman Road  
**CITY/STATE:** Stockton, CA

**QC JOB #:** 14437908  
**DATE:** Thu, Jun 01 2017

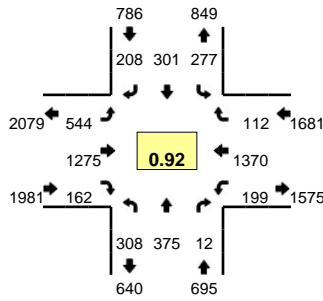

**Peak-Hour: 4:55 PM -- 5:55 PM**  
**Peak 15-Min: 5:10 PM -- 5:25 PM**

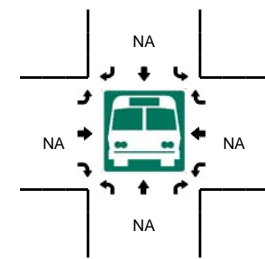
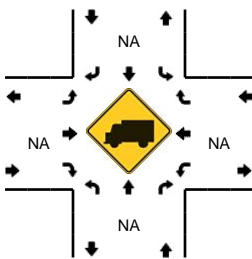
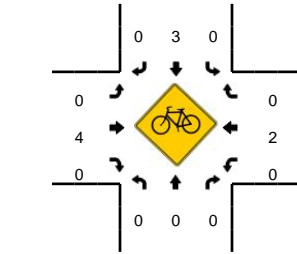
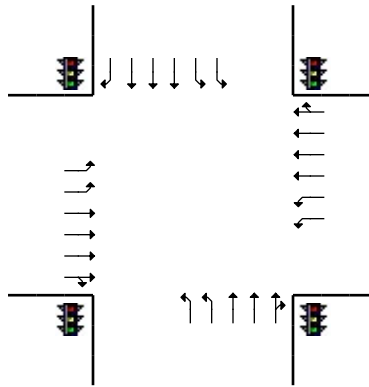
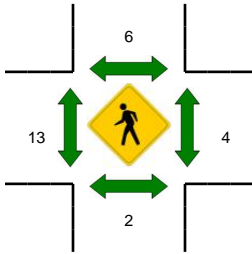
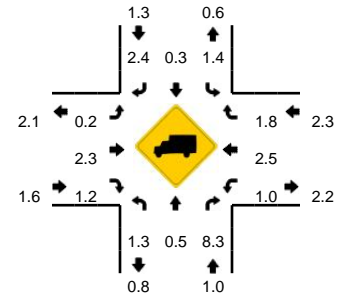

| 5-Min Count Period Beginning At | 4. Hammer Lane (Northbound) |      |       |    | 4. Hammer Lane (Southbound) |      |       |    | Holman Road (Eastbound) |      |       |     | Holman Road (Westbound) |      |       |    | Total | Hourly Totals |
|---------------------------------|-----------------------------|------|-------|----|-----------------------------|------|-------|----|-------------------------|------|-------|-----|-------------------------|------|-------|----|-------|---------------|
|                                 | Left                        | Thru | Right | U  | Left                        | Thru | Right | U  | Left                    | Thru | Right | U   | Left                    | Thru | Right | U  |       |               |
| 4:00 PM                         | 15                          | 14   | 0     | 0  | 31                          | 24   | 13    | 1  | 37                      | 90   | 17    | 15  | 18                      | 85   | 3     | 1  | 364   |               |
| 4:05 PM                         | 29                          | 43   | 3     | 1  | 17                          | 27   | 11    | 1  | 21                      | 96   | 16    | 12  | 17                      | 87   | 11    | 0  | 392   |               |
| 4:10 PM                         | 17                          | 28   | 0     | 2  | 17                          | 35   | 23    | 5  | 25                      | 118  | 16    | 11  | 11                      | 107  | 7     | 2  | 424   |               |
| 4:15 PM                         | 37                          | 41   | 1     | 1  | 20                          | 16   | 15    | 1  | 19                      | 99   | 16    | 15  | 21                      | 140  | 16    | 1  | 459   |               |
| 4:20 PM                         | 25                          | 26   | 5     | 0  | 27                          | 21   | 17    | 3  | 22                      | 99   | 20    | 18  | 10                      | 117  | 7     | 2  | 419   |               |
| 4:25 PM                         | 27                          | 36   | 4     | 1  | 18                          | 18   | 17    | 0  | 42                      | 95   | 17    | 11  | 19                      | 98   | 9     | 1  | 413   |               |
| 4:30 PM                         | 30                          | 21   | 2     | 0  | 19                          | 20   | 13    | 5  | 26                      | 118  | 13    | 11  | 7                       | 76   | 10    | 2  | 373   |               |
| 4:35 PM                         | 24                          | 32   | 1     | 0  | 20                          | 18   | 14    | 2  | 24                      | 83   | 12    | 20  | 20                      | 109  | 13    | 2  | 394   |               |
| 4:40 PM                         | 21                          | 36   | 3     | 1  | 26                          | 26   | 16    | 0  | 25                      | 128  | 20    | 10  | 13                      | 97   | 5     | 1  | 428   |               |
| 4:45 PM                         | 38                          | 22   | 0     | 0  | 16                          | 15   | 10    | 3  | 23                      | 62   | 13    | 20  | 10                      | 120  | 6     | 1  | 359   |               |
| 4:50 PM                         | 24                          | 25   | 3     | 0  | 24                          | 32   | 24    | 0  | 28                      | 121  | 14    | 18  | 7                       | 68   | 7     | 0  | 395   |               |
| 4:55 PM                         | 26                          | 45   | 0     | 1  | 12                          | 26   | 17    | 0  | 24                      | 112  | 10    | 18  | 14                      | 133  | 14    | 2  | 454   | 4874          |
| 5:00 PM                         | 24                          | 22   | 0     | 1  | 24                          | 24   | 15    | 2  | 23                      | 107  | 14    | 11  | 14                      | 92   | 7     | 2  | 382   | 4892          |
| 5:05 PM                         | 27                          | 44   | 0     | 0  | 15                          | 30   | 9     | 4  | 24                      | 106  | 18    | 15  | 14                      | 117  | 10    | 7  | 440   | 4940          |
| 5:10 PM                         | 22                          | 37   | 0     | 1  | 30                          | 35   | 17    | 2  | 17                      | 93   | 9     | 14  | 11                      | 116  | 10    | 2  | 416   | 4932          |
| 5:15 PM                         | 32                          | 37   | 1     | 2  | 21                          | 22   | 10    | 3  | 39                      | 132  | 8     | 23  | 19                      | 131  | 10    | 1  | 491   | 4964          |
| 5:20 PM                         | 16                          | 28   | 2     | 0  | 35                          | 26   | 28    | 1  | 39                      | 142  | 20    | 21  | 18                      | 106  | 3     | 1  | 486   | 5031          |
| 5:25 PM                         | 38                          | 43   | 1     | 0  | 18                          | 19   | 13    | 1  | 40                      | 68   | 12    | 14  | 15                      | 114  | 12    | 4  | 412   | 5030          |
| 5:30 PM                         | 22                          | 15   | 3     | 0  | 22                          | 20   | 8     | 2  | 31                      | 114  | 13    | 11  | 17                      | 116  | 12    | 3  | 409   | 5066          |
| 5:35 PM                         | 22                          | 31   | 2     | 1  | 20                          | 21   | 17    | 1  | 26                      | 109  | 15    | 14  | 9                       | 120  | 10    | 2  | 420   | 5092          |
| 5:40 PM                         | 23                          | 19   | 2     | 0  | 21                          | 38   | 28    | 0  | 32                      | 111  | 18    | 23  | 17                      | 95   | 9     | 2  | 438   | 5102          |
| 5:45 PM                         | 27                          | 31   | 1     | 0  | 15                          | 17   | 24    | 0  | 19                      | 83   | 10    | 14  | 9                       | 129  | 9     | 2  | 390   | 5133          |
| 5:50 PM                         | 23                          | 23   | 0     | 0  | 27                          | 23   | 22    | 1  | 31                      | 98   | 15    | 21  | 14                      | 101  | 6     | 0  | 405   | 5143          |
| 5:55 PM                         | 36                          | 40   | 4     | 1  | 14                          | 20   | 14    | 2  | 28                      | 85   | 10    | 12  | 10                      | 113  | 13    | 1  | 403   | 5092          |
| Peak 15-Min Flowrates           | Northbound                  |      |       |    | Southbound                  |      |       |    | Eastbound               |      |       |     | Westbound               |      |       |    | Total |               |
|                                 | Left                        | Thru | Right | U  | Left                        | Thru | Right | U  | Left                    | Thru | Right | U   | Left                    | Thru | Right | U  |       |               |
| All Vehicles                    | 280                         | 408  | 12    | 12 | 344                         | 332  | 220   | 24 | 380                     | 1468 | 148   | 232 | 192                     | 1412 | 92    | 16 | 5572  |               |
| Heavy Trucks                    | 4                           | 4    | 0     |    | 4                           | 0    | 4     |    | 0                       | 36   | 0     |     | 0                       | 28   | 0     |    | 80    |               |
| Pedestrians                     |                             | 4    |       |    |                             | 8    |       |    |                         | 24   |       |     |                         | 4    |       |    | 40    |               |
| Bicycles                        | 0                           | 0    | 0     |    | 0                           | 3    | 0     |    | 0                       | 3    | 0     |     | 0                       | 2    | 0     |    | 8     |               |
| Railroad                        |                             |      |       |    |                             |      |       |    |                         |      |       |     |                         |      |       |    |       |               |
| Stopped Buses                   |                             |      |       |    |                             |      |       |    |                         |      |       |     |                         |      |       |    |       |               |

Comments:

**LOCATION:** 5. Thorton Rd -- Lower Sacramento Rd  
**CITY/STATE:** Stockton, CA

**QC JOB #:** 14437909  
**DATE:** Thu, Jun 01 2017

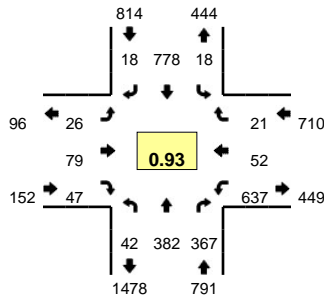

**Peak-Hour: 7:45 AM -- 8:45 AM**  
**Peak 15-Min: 8:05 AM -- 8:20 AM**

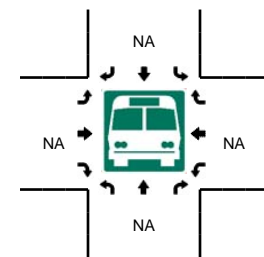
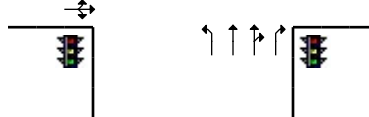
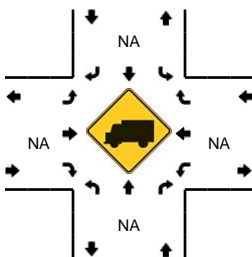
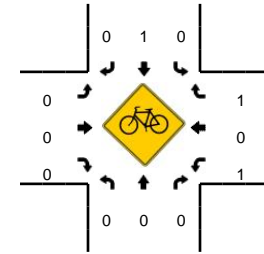
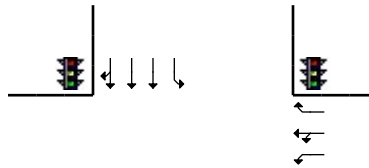
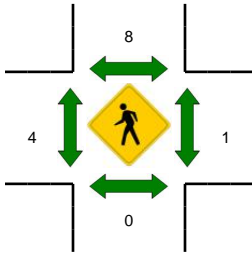
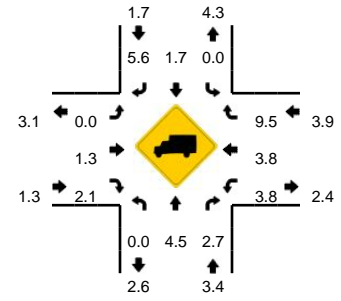

| 5-Min Count Period Beginning At | 5. Thorton Rd (Northbound) |      |       |    | 5. Thorton Rd (Southbound) |      |       |    | Lower Sacramento Rd (Eastbound) |      |       |   | Lower Sacramento Rd (Westbound) |      |       |   | Total | Hourly Totals |
|---------------------------------|----------------------------|------|-------|----|----------------------------|------|-------|----|---------------------------------|------|-------|---|---------------------------------|------|-------|---|-------|---------------|
|                                 | Left                       | Thru | Right | U  | Left                       | Thru | Right | U  | Left                            | Thru | Right | U | Left                            | Thru | Right | U |       |               |
| 7:00 AM                         | 2                          | 15   | 14    | 1  | 0                          | 39   | 0     | 2  | 0                               | 3    | 1     | 0 | 21                              | 2    | 1     | 0 | 101   |               |
| 7:05 AM                         | 1                          | 15   | 14    | 0  | 0                          | 44   | 0     | 1  | 2                               | 4    | 1     | 0 | 27                              | 4    | 2     | 0 | 115   |               |
| 7:10 AM                         | 1                          | 10   | 24    | 1  | 0                          | 39   | 1     | 1  | 1                               | 1    | 3     | 0 | 34                              | 3    | 0     | 0 | 119   |               |
| 7:15 AM                         | 0                          | 12   | 20    | 1  | 0                          | 50   | 0     | 0  | 1                               | 4    | 1     | 0 | 37                              | 1    | 0     | 0 | 127   |               |
| 7:20 AM                         | 0                          | 12   | 19    | 0  | 0                          | 66   | 1     | 1  | 2                               | 6    | 1     | 0 | 36                              | 2    | 1     | 0 | 147   |               |
| 7:25 AM                         | 1                          | 17   | 27    | 1  | 1                          | 47   | 0     | 1  | 0                               | 6    | 3     | 0 | 49                              | 5    | 0     | 0 | 158   |               |
| 7:30 AM                         | 0                          | 20   | 24    | 2  | 0                          | 47   | 1     | 3  | 0                               | 6    | 4     | 0 | 66                              | 6    | 0     | 0 | 179   |               |
| 7:35 AM                         | 1                          | 14   | 22    | 2  | 0                          | 65   | 1     | 1  | 1                               | 5    | 7     | 0 | 44                              | 4    | 1     | 0 | 168   |               |
| 7:40 AM                         | 1                          | 33   | 23    | 2  | 1                          | 66   | 0     | 1  | 3                               | 4    | 1     | 0 | 37                              | 3    | 0     | 0 | 175   |               |
| 7:45 AM                         | 4                          | 23   | 33    | 0  | 0                          | 65   | 0     | 2  | 4                               | 8    | 1     | 0 | 70                              | 8    | 2     | 0 | 220   |               |
| 7:50 AM                         | 1                          | 40   | 25    | 3  | 0                          | 74   | 1     | 1  | 1                               | 6    | 6     | 0 | 62                              | 6    | 0     | 0 | 226   |               |
| 7:55 AM                         | 1                          | 30   | 23    | 1  | 0                          | 77   | 3     | 1  | 2                               | 4    | 1     | 0 | 24                              | 3    | 0     | 0 | 170   | 1905          |
| 8:00 AM                         | 3                          | 19   | 18    | 1  | 0                          | 73   | 0     | 2  | 0                               | 3    | 3     | 0 | 24                              | 1    | 3     | 0 | 150   | 1954          |
| 8:05 AM                         | 1                          | 34   | 43    | 1  | 0                          | 48   | 0     | 2  | 5                               | 12   | 5     | 0 | 77                              | 8    | 2     | 0 | 238   | 2077          |
| 8:10 AM                         | 3                          | 33   | 32    | 2  | 0                          | 55   | 2     | 3  | 2                               | 8    | 10    | 0 | 61                              | 6    | 1     | 0 | 218   | 2176          |
| 8:15 AM                         | 1                          | 33   | 28    | 1  | 0                          | 79   | 4     | 1  | 2                               | 9    | 4     | 0 | 40                              | 5    | 3     | 0 | 210   | 2259          |
| 8:20 AM                         | 2                          | 40   | 31    | 1  | 1                          | 49   | 1     | 1  | 4                               | 14   | 5     | 0 | 63                              | 4    | 6     | 0 | 222   | 2334          |
| 8:25 AM                         | 3                          | 31   | 34    | 1  | 0                          | 67   | 3     | 0  | 4                               | 7    | 3     | 0 | 71                              | 3    | 1     | 0 | 228   | 2404          |
| 8:30 AM                         | 0                          | 38   | 30    | 1  | 1                          | 63   | 1     | 1  | 1                               | 4    | 3     | 0 | 39                              | 3    | 0     | 0 | 185   | 2410          |
| 8:35 AM                         | 2                          | 30   | 27    | 0  | 1                          | 65   | 2     | 1  | 1                               | 3    | 3     | 0 | 52                              | 1    | 1     | 0 | 189   | 2431          |
| 8:40 AM                         | 5                          | 31   | 43    | 4  | 0                          | 63   | 1     | 0  | 0                               | 1    | 3     | 0 | 54                              | 4    | 2     | 0 | 211   | 2467          |
| 8:45 AM                         | 1                          | 16   | 35    | 3  | 0                          | 60   | 2     | 3  | 0                               | 2    | 3     | 0 | 44                              | 1    | 2     | 0 | 172   | 2419          |
| 8:50 AM                         | 5                          | 32   | 22    | 1  | 0                          | 64   | 0     | 1  | 2                               | 7    | 3     | 0 | 32                              | 5    | 1     | 0 | 175   | 2368          |
| 8:55 AM                         | 3                          | 26   | 31    | 0  | 0                          | 61   | 0     | 1  | 0                               | 1    | 4     | 0 | 59                              | 2    | 3     | 0 | 191   | 2389          |
| Peak 15-Min Flowrates           | Northbound                 |      |       |    | Southbound                 |      |       |    | Eastbound                       |      |       |   | Westbound                       |      |       |   | Total |               |
|                                 | Left                       | Thru | Right | U  | Left                       | Thru | Right | U  | Left                            | Thru | Right | U | Left                            | Thru | Right | U |       |               |
| All Vehicles                    | 20                         | 400  | 412   | 16 | 0                          | 728  | 24    | 24 | 36                              | 116  | 76    | 0 | 712                             | 76   | 24    | 0 | 2664  |               |
| Heavy Trucks                    | 0                          | 20   | 4     |    | 0                          | 20   | 4     |    | 0                               | 0    | 0     |   | 24                              | 8    | 0     |   | 80    |               |
| Pedestrians                     |                            | 0    |       |    |                            | 8    |       |    |                                 | 4    |       |   |                                 | 0    |       |   | 12    |               |
| Bicycles                        | 0                          | 0    | 0     |    | 0                          | 1    | 0     |    | 0                               | 0    | 0     |   | 0                               | 0    | 1     |   | 2     |               |
| Railroad                        |                            |      |       |    |                            |      |       |    |                                 |      |       |   |                                 |      |       |   |       |               |
| Stopped Buses                   |                            |      |       |    |                            |      |       |    |                                 |      |       |   |                                 |      |       |   |       |               |

Comments:

**LOCATION:** 5. Thorton Rd -- Lower Sacramento Rd  
**CITY/STATE:** Stockton, CA

**QC JOB #:** 14437910  
**DATE:** Thu, Jun 01 2017

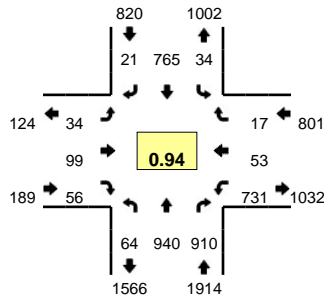

**Peak-Hour: 4:50 PM -- 5:50 PM**  
**Peak 15-Min: 5:25 PM -- 5:40 PM**

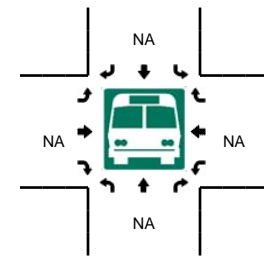
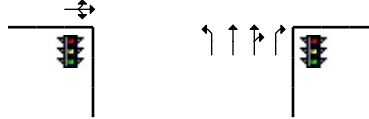
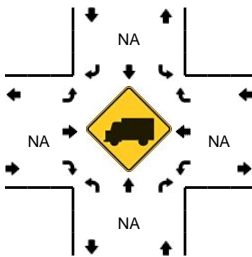
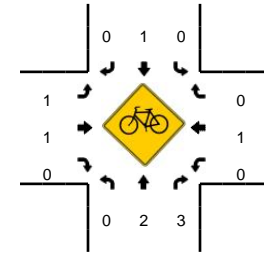
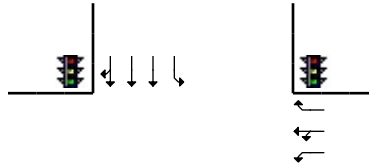
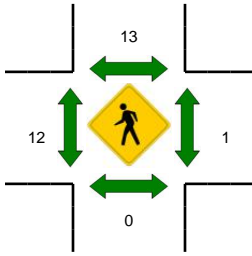
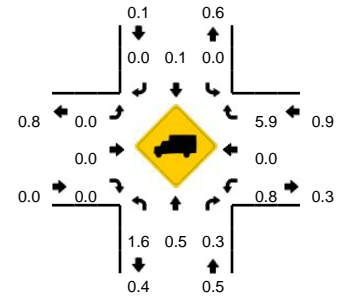

| 5-Min Count Period Beginning At | 5. Thorton Rd (Southbound) |      |       |   | 5. Thorton Rd (Northbound) |      |       |   | Lower Sacramento Rd (Eastbound) |      |       |   | Lower Sacramento Rd (Westbound) |      |       |   | Total | Hourly Totals |
|---------------------------------|----------------------------|------|-------|---|----------------------------|------|-------|---|---------------------------------|------|-------|---|---------------------------------|------|-------|---|-------|---------------|
|                                 | Left                       | Thru | Right | U | Left                       | Thru | Right | U | Left                            | Thru | Right | U | Left                            | Thru | Right | U |       |               |
| 4:00 PM                         | 2                          | 72   | 78    | 1 | 2                          | 54   | 2     | 0 | 0                               | 7    | 5     | 0 | 42                              | 0    | 1     | 0 | 266   |               |
| 4:05 PM                         | 4                          | 71   | 60    | 3 | 2                          | 68   | 3     | 1 | 4                               | 7    | 2     | 0 | 63                              | 1    | 0     | 0 | 289   |               |
| 4:10 PM                         | 3                          | 74   | 83    | 3 | 1                          | 42   | 2     | 1 | 0                               | 4    | 7     | 0 | 50                              | 2    | 0     | 0 | 272   |               |
| 4:15 PM                         | 3                          | 73   | 71    | 1 | 1                          | 46   | 2     | 2 | 4                               | 2    | 3     | 0 | 52                              | 1    | 2     | 0 | 263   |               |
| 4:20 PM                         | 2                          | 74   | 88    | 3 | 3                          | 57   | 1     | 1 | 2                               | 4    | 4     | 0 | 51                              | 5    | 0     | 0 | 295   |               |
| 4:25 PM                         | 4                          | 69   | 71    | 1 | 0                          | 58   | 4     | 0 | 3                               | 7    | 3     | 0 | 60                              | 5    | 1     | 0 | 286   |               |
| 4:30 PM                         | 2                          | 69   | 69    | 2 | 0                          | 43   | 3     | 0 | 2                               | 6    | 1     | 0 | 53                              | 2    | 1     | 0 | 253   |               |
| 4:35 PM                         | 5                          | 58   | 64    | 3 | 0                          | 51   | 4     | 1 | 2                               | 3    | 1     | 0 | 52                              | 1    | 2     | 0 | 247   |               |
| 4:40 PM                         | 5                          | 64   | 79    | 1 | 0                          | 61   | 0     | 4 | 6                               | 3    | 7     | 0 | 43                              | 6    | 1     | 0 | 280   |               |
| 4:45 PM                         | 1                          | 58   | 72    | 0 | 2                          | 51   | 3     | 0 | 2                               | 10   | 4     | 0 | 72                              | 5    | 1     | 0 | 281   |               |
| 4:50 PM                         | 6                          | 88   | 72    | 1 | 2                          | 75   | 3     | 1 | 0                               | 8    | 4     | 0 | 50                              | 6    | 0     | 0 | 316   |               |
| 4:55 PM                         | 7                          | 58   | 84    | 0 | 5                          | 71   | 2     | 3 | 4                               | 10   | 5     | 0 | 48                              | 2    | 0     | 0 | 299   | 3347          |
| 5:00 PM                         | 5                          | 72   | 71    | 3 | 1                          | 54   | 0     | 1 | 4                               | 7    | 4     | 0 | 41                              | 1    | 2     | 0 | 266   | 3347          |
| 5:05 PM                         | 3                          | 74   | 65    | 1 | 1                          | 47   | 0     | 0 | 3                               | 10   | 0     | 0 | 72                              | 3    | 2     | 0 | 281   | 3339          |
| 5:10 PM                         | 4                          | 94   | 90    | 3 | 0                          | 66   | 2     | 0 | 2                               | 10   | 3     | 0 | 35                              | 6    | 3     | 0 | 318   | 3385          |
| 5:15 PM                         | 3                          | 64   | 71    | 1 | 4                          | 55   | 2     | 2 | 2                               | 8    | 6     | 0 | 80                              | 5    | 1     | 0 | 304   | 3426          |
| 5:20 PM                         | 5                          | 101  | 69    | 1 | 0                          | 61   | 2     | 1 | 2                               | 3    | 5     | 0 | 56                              | 3    | 1     | 0 | 310   | 3441          |
| 5:25 PM                         | 1                          | 75   | 89    | 0 | 1                          | 66   | 1     | 0 | 4                               | 14   | 8     | 0 | 79                              | 5    | 2     | 0 | 345   | 3500          |
| 5:30 PM                         | 7                          | 89   | 77    | 1 | 2                          | 83   | 2     | 0 | 4                               | 4    | 5     | 0 | 55                              | 1    | 1     | 0 | 331   | 3578          |
| 5:35 PM                         | 3                          | 60   | 78    | 1 | 4                          | 60   | 3     | 1 | 3                               | 8    | 9     | 0 | 73                              | 10   | 2     | 0 | 315   | 3646          |
| 5:40 PM                         | 3                          | 96   | 84    | 2 | 1                          | 64   | 4     | 1 | 3                               | 5    | 2     | 0 | 52                              | 6    | 2     | 0 | 325   | 3691          |
| 5:45 PM                         | 3                          | 69   | 60    | 0 | 2                          | 63   | 0     | 1 | 3                               | 12   | 5     | 0 | 90                              | 5    | 1     | 0 | 314   | 3724          |
| 5:50 PM                         | 3                          | 78   | 71    | 3 | 2                          | 76   | 4     | 1 | 3                               | 5    | 8     | 0 | 50                              | 2    | 0     | 0 | 306   | 3714          |
| 5:55 PM                         | 2                          | 46   | 45    | 3 | 0                          | 51   | 3     | 0 | 1                               | 6    | 4     | 0 | 98                              | 5    | 6     | 0 | 270   | 3685          |
| Peak 15-Min Flowrates           | Northbound                 |      |       |   | Southbound                 |      |       |   | Eastbound                       |      |       |   | Westbound                       |      |       |   | Total |               |
|                                 | Left                       | Thru | Right | U | Left                       | Thru | Right | U | Left                            | Thru | Right | U | Left                            | Thru | Right | U |       |               |
| All Vehicles                    | 44                         | 896  | 976   | 8 | 28                         | 836  | 24    | 4 | 44                              | 104  | 88    | 0 | 828                             | 64   | 20    | 0 | 3964  |               |
| Heavy Trucks                    | 0                          | 4    | 4     |   | 0                          | 0    | 0     |   | 0                               | 0    | 0     |   | 8                               | 0    | 0     |   | 16    |               |
| Pedestrians                     |                            | 0    |       |   |                            | 4    |       |   |                                 | 4    |       |   |                                 | 0    |       |   | 8     |               |
| Bicycles                        | 0                          | 0    | 0     |   | 0                          | 1    | 0     |   | 0                               | 0    | 0     |   | 0                               | 0    | 0     |   | 1     |               |
| Railroad                        |                            |      |       |   |                            |      |       |   |                                 |      |       |   |                                 |      |       |   |       |               |
| Stopped Buses                   |                            |      |       |   |                            |      |       |   |                                 |      |       |   |                                 |      |       |   |       |               |

Comments:

**LOCATION:** 6. Feather River Dr -- March Ln  
**CITY/STATE:** Stockton, CA

**QC JOB #:** 14437911  
**DATE:** Thu, Jun 01 2017

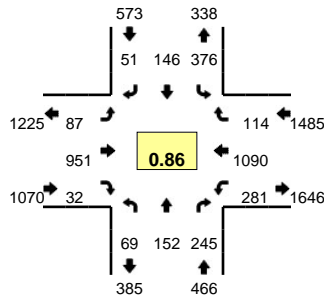

**Peak-Hour: 7:25 AM -- 8:25 AM**  
**Peak 15-Min: 7:45 AM -- 8:00 AM**

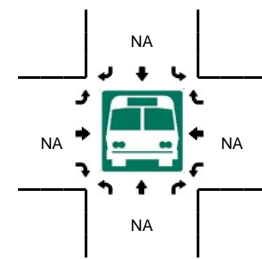
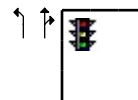
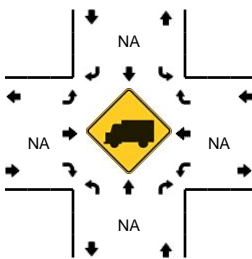
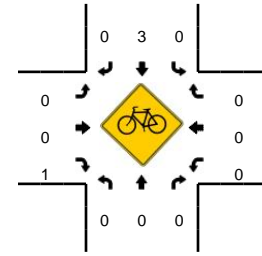
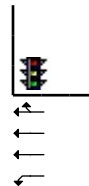
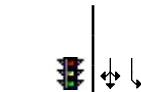
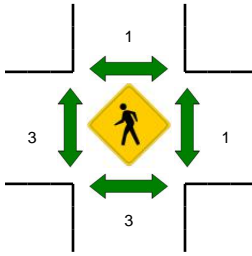
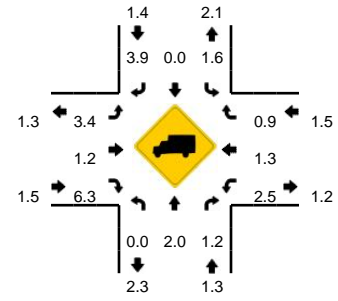

| 5-Min Count Period Beginning At | 6. Feather River Dr (Northbound) |      |       |   | 6. Feather River Dr (Southbound) |      |       |   | March Ln (Eastbound) |      |       |    | March Ln (Westbound) |      |       |    | Total | Hourly Totals |
|---------------------------------|----------------------------------|------|-------|---|----------------------------------|------|-------|---|----------------------|------|-------|----|----------------------|------|-------|----|-------|---------------|
|                                 | Left                             | Thru | Right | U | Left                             | Thru | Right | U | Left                 | Thru | Right | U  | Left                 | Thru | Right | U  |       |               |
| 7:00 AM                         | 1                                | 4    | 7     | 0 | 31                               | 1    | 2     | 0 | 2                    | 36   | 1     | 0  | 2                    | 26   | 3     | 4  | 120   |               |
| 7:05 AM                         | 1                                | 8    | 11    | 0 | 30                               | 2    | 3     | 0 | 0                    | 54   | 1     | 0  | 11                   | 53   | 5     | 8  | 187   |               |
| 7:10 AM                         | 1                                | 7    | 14    | 0 | 29                               | 2    | 4     | 0 | 1                    | 45   | 2     | 0  | 6                    | 50   | 9     | 4  | 174   |               |
| 7:15 AM                         | 3                                | 5    | 10    | 0 | 44                               | 6    | 6     | 0 | 5                    | 44   | 0     | 1  | 6                    | 55   | 4     | 4  | 193   |               |
| 7:20 AM                         | 3                                | 5    | 12    | 0 | 38                               | 6    | 8     | 0 | 3                    | 82   | 0     | 0  | 4                    | 41   | 5     | 2  | 209   |               |
| 7:25 AM                         | 6                                | 14   | 14    | 0 | 20                               | 7    | 3     | 0 | 5                    | 61   | 1     | 2  | 7                    | 68   | 7     | 5  | 220   |               |
| 7:30 AM                         | 4                                | 9    | 19    | 0 | 40                               | 12   | 4     | 0 | 2                    | 60   | 4     | 3  | 20                   | 69   | 5     | 4  | 255   |               |
| 7:35 AM                         | 5                                | 14   | 26    | 0 | 33                               | 11   | 6     | 0 | 5                    | 68   | 2     | 1  | 21                   | 69   | 7     | 6  | 274   |               |
| 7:40 AM                         | 5                                | 9    | 22    | 0 | 25                               | 17   | 3     | 0 | 6                    | 66   | 3     | 2  | 26                   | 100  | 3     | 3  | 290   |               |
| 7:45 AM                         | 7                                | 16   | 28    | 0 | 31                               | 18   | 2     | 0 | 7                    | 114  | 2     | 1  | 20                   | 119  | 7     | 6  | 378   |               |
| 7:50 AM                         | 14                               | 22   | 42    | 0 | 24                               | 14   | 8     | 0 | 5                    | 73   | 3     | 1  | 15                   | 113  | 8     | 5  | 347   |               |
| 7:55 AM                         | 8                                | 14   | 19    | 0 | 33                               | 17   | 5     | 0 | 9                    | 76   | 6     | 1  | 13                   | 102  | 11    | 6  | 320   | 2967          |
| 8:00 AM                         | 8                                | 17   | 21    | 0 | 28                               | 8    | 6     | 0 | 6                    | 83   | 3     | 0  | 23                   | 119  | 14    | 4  | 340   | 3187          |
| 8:05 AM                         | 3                                | 13   | 26    | 0 | 35                               | 11   | 5     | 0 | 12                   | 83   | 1     | 2  | 21                   | 89   | 9     | 11 | 321   | 3321          |
| 8:10 AM                         | 1                                | 10   | 8     | 0 | 34                               | 8    | 3     | 0 | 6                    | 105  | 3     | 0  | 15                   | 81   | 18    | 14 | 306   | 3453          |
| 8:15 AM                         | 3                                | 8    | 13    | 0 | 46                               | 13   | 3     | 0 | 3                    | 66   | 3     | 0  | 13                   | 62   | 14    | 5  | 252   | 3512          |
| 8:20 AM                         | 5                                | 6    | 7     | 0 | 27                               | 10   | 3     | 0 | 6                    | 96   | 1     | 2  | 13                   | 99   | 11    | 5  | 291   | 3594          |
| 8:25 AM                         | 8                                | 5    | 16    | 0 | 42                               | 6    | 8     | 0 | 4                    | 40   | 3     | 1  | 5                    | 67   | 6     | 7  | 218   | 3592          |
| 8:30 AM                         | 6                                | 12   | 8     | 0 | 21                               | 2    | 1     | 0 | 5                    | 65   | 1     | 0  | 9                    | 84   | 11    | 7  | 232   | 3569          |
| 8:35 AM                         | 0                                | 1    | 4     | 0 | 29                               | 8    | 5     | 0 | 6                    | 79   | 1     | 0  | 2                    | 81   | 11    | 7  | 234   | 3529          |
| 8:40 AM                         | 4                                | 5    | 5     | 0 | 32                               | 12   | 3     | 0 | 2                    | 53   | 1     | 0  | 5                    | 57   | 10    | 3  | 192   | 3431          |
| 8:45 AM                         | 9                                | 5    | 7     | 0 | 29                               | 5    | 3     | 0 | 0                    | 55   | 0     | 0  | 9                    | 62   | 7     | 10 | 201   | 3254          |
| 8:50 AM                         | 7                                | 2    | 5     | 0 | 23                               | 3    | 5     | 0 | 4                    | 56   | 4     | 0  | 8                    | 69   | 11    | 7  | 204   | 3111          |
| 8:55 AM                         | 3                                | 5    | 9     | 0 | 33                               | 5    | 5     | 0 | 1                    | 61   | 1     | 2  | 4                    | 80   | 10    | 10 | 229   | 3020          |
| Peak 15-Min Flowrates           | Northbound                       |      |       |   | Southbound                       |      |       |   | Eastbound            |      |       |    | Westbound            |      |       |    | Total |               |
|                                 | Left                             | Thru | Right | U | Left                             | Thru | Right | U | Left                 | Thru | Right | U  | Left                 | Thru | Right | U  |       |               |
| All Vehicles                    | 116                              | 208  | 356   | 0 | 352                              | 196  | 60    | 0 | 84                   | 1052 | 44    | 12 | 192                  | 1336 | 104   | 68 | 4180  |               |
| Heavy Trucks                    | 0                                | 8    | 4     | 0 | 0                                | 0    | 0     | 0 | 0                    | 4    | 0     | 0  | 12                   | 8    | 0     | 0  | 36    |               |
| Pedestrians                     | 4                                |      |       |   | 0                                |      |       |   | 0                    | 12   |       |    | 0                    | 0    |       |    | 16    |               |
| Bicycles                        | 0                                | 0    | 0     |   | 0                                | 0    | 0     |   | 0                    | 0    | 0     |    | 0                    | 0    | 0     |    | 0     |               |
| Railroad                        |                                  |      |       |   |                                  |      |       |   |                      |      |       |    |                      |      |       |    |       |               |
| Stopped Buses                   |                                  |      |       |   |                                  |      |       |   |                      |      |       |    |                      |      |       |    |       |               |

Comments:

**LOCATION:** 6. Feather River Dr -- March Ln  
**CITY/STATE:** Stockton, CA

**QC JOB #:** 14437912  
**DATE:** Thu, Jun 01 2017

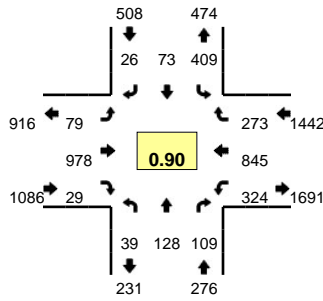

**Peak-Hour: 4:45 PM -- 5:45 PM**  
**Peak 15-Min: 5:05 PM -- 5:20 PM**

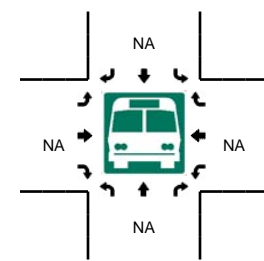
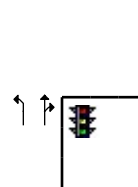
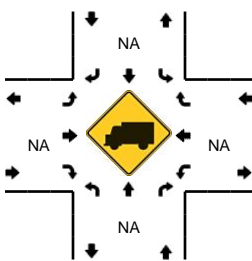
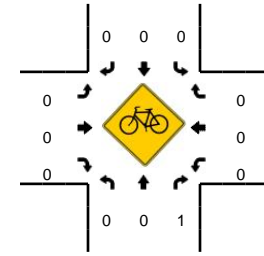
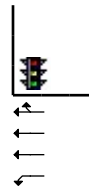
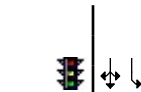
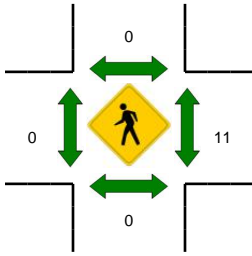
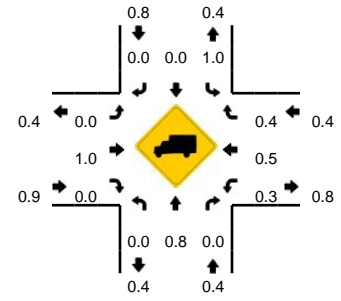

| 5-Min Count Period Beginning At | 6. Feather River Dr (Northbound) |      |       |   | 6. Feather River Dr (Southbound) |      |       |   | March Ln (Eastbound) |      |       |   | March Ln (Westbound) |      |       |     | Total | Hourly Totals |
|---------------------------------|----------------------------------|------|-------|---|----------------------------------|------|-------|---|----------------------|------|-------|---|----------------------|------|-------|-----|-------|---------------|
|                                 | Left                             | Thru | Right | U | Left                             | Thru | Right | U | Left                 | Thru | Right | U | Left                 | Thru | Right | U   |       |               |
| 4:00 PM                         | 3                                | 8    | 2     | 0 | 44                               | 5    | 5     | 0 | 0                    | 73   | 0     | 0 | 4                    | 51   | 11    | 11  | 217   |               |
| 4:05 PM                         | 2                                | 7    | 8     | 0 | 32                               | 7    | 1     | 0 | 6                    | 89   | 1     | 0 | 8                    | 71   | 28    | 13  | 273   |               |
| 4:10 PM                         | 1                                | 6    | 7     | 0 | 45                               | 4    | 3     | 0 | 4                    | 59   | 2     | 0 | 10                   | 56   | 19    | 17  | 233   |               |
| 4:15 PM                         | 2                                | 5    | 8     | 0 | 30                               | 5    | 5     | 0 | 3                    | 92   | 6     | 0 | 5                    | 66   | 30    | 20  | 277   |               |
| 4:20 PM                         | 2                                | 7    | 9     | 0 | 52                               | 5    | 1     | 0 | 15                   | 80   | 1     | 0 | 11                   | 49   | 13    | 19  | 264   |               |
| 4:25 PM                         | 3                                | 17   | 10    | 0 | 25                               | 1    | 5     | 0 | 4                    | 89   | 3     | 1 | 12                   | 79   | 23    | 20  | 292   |               |
| 4:30 PM                         | 3                                | 7    | 9     | 0 | 36                               | 7    | 2     | 0 | 7                    | 48   | 3     | 0 | 9                    | 45   | 29    | 22  | 227   |               |
| 4:35 PM                         | 3                                | 16   | 3     | 0 | 20                               | 0    | 5     | 0 | 4                    | 100  | 4     | 0 | 6                    | 71   | 15    | 14  | 261   |               |
| 4:40 PM                         | 1                                | 6    | 15    | 0 | 42                               | 4    | 8     | 0 | 10                   | 59   | 1     | 0 | 5                    | 45   | 13    | 24  | 233   |               |
| 4:45 PM                         | 8                                | 9    | 9     | 0 | 27                               | 7    | 1     | 0 | 4                    | 95   | 3     | 2 | 10                   | 74   | 22    | 19  | 290   |               |
| 4:50 PM                         | 2                                | 8    | 7     | 0 | 29                               | 9    | 2     | 0 | 5                    | 67   | 1     | 1 | 8                    | 72   | 22    | 18  | 251   |               |
| 4:55 PM                         | 2                                | 14   | 7     | 0 | 25                               | 6    | 3     | 0 | 6                    | 99   | 2     | 0 | 7                    | 77   | 16    | 20  | 284   | 3102          |
| 5:00 PM                         | 5                                | 14   | 18    | 0 | 44                               | 5    | 1     | 0 | 5                    | 65   | 3     | 0 | 10                   | 54   | 19    | 13  | 256   | 3141          |
| 5:05 PM                         | 3                                | 13   | 7     | 0 | 28                               | 5    | 1     | 0 | 8                    | 119  | 2     | 0 | 13                   | 79   | 35    | 18  | 331   | 3199          |
| 5:10 PM                         | 2                                | 14   | 11    | 0 | 43                               | 6    | 3     | 0 | 12                   | 69   | 5     | 0 | 11                   | 57   | 22    | 14  | 269   | 3235          |
| 5:15 PM                         | 7                                | 13   | 7     | 0 | 31                               | 4    | 0     | 0 | 6                    | 115  | 3     | 0 | 13                   | 86   | 21    | 18  | 324   | 3282          |
| 5:20 PM                         | 0                                | 12   | 5     | 0 | 34                               | 6    | 3     | 0 | 8                    | 75   | 3     | 1 | 9                    | 51   | 20    | 20  | 247   | 3265          |
| 5:25 PM                         | 0                                | 12   | 13    | 0 | 25                               | 6    | 2     | 0 | 3                    | 87   | 3     | 0 | 11                   | 69   | 23    | 16  | 270   | 3243          |
| 5:30 PM                         | 3                                | 5    | 11    | 0 | 43                               | 7    | 7     | 0 | 5                    | 54   | 1     | 1 | 19                   | 61   | 32    | 12  | 261   | 3277          |
| 5:35 PM                         | 4                                | 10   | 7     | 0 | 31                               | 4    | 1     | 0 | 3                    | 86   | 3     | 1 | 7                    | 91   | 26    | 11  | 285   | 3301          |
| 5:40 PM                         | 3                                | 4    | 7     | 0 | 49                               | 8    | 2     | 0 | 8                    | 47   | 0     | 0 | 11                   | 74   | 15    | 16  | 244   | 3312          |
| 5:45 PM                         | 6                                | 14   | 7     | 0 | 22                               | 2    | 4     | 0 | 0                    | 80   | 4     | 0 | 14                   | 91   | 25    | 8   | 277   | 3299          |
| 5:50 PM                         | 4                                | 9    | 5     | 0 | 44                               | 8    | 1     | 0 | 1                    | 53   | 2     | 0 | 13                   | 82   | 15    | 14  | 251   | 3299          |
| 5:55 PM                         | 1                                | 6    | 3     | 0 | 30                               | 3    | 1     | 0 | 7                    | 70   | 7     | 1 | 11                   | 97   | 20    | 13  | 270   | 3285          |
| Peak 15-Min Flowrates           | Northbound                       |      |       |   | Southbound                       |      |       |   | Eastbound            |      |       |   | Westbound            |      |       |     | Total |               |
|                                 | Left                             | Thru | Right | U | Left                             | Thru | Right | U | Left                 | Thru | Right | U | Left                 | Thru | Right | U   |       |               |
| All Vehicles                    | 48                               | 160  | 100   | 0 | 408                              | 60   | 16    | 0 | 104                  | 1212 | 40    | 0 | 148                  | 888  | 312   | 200 | 3696  |               |
| Heavy Trucks                    | 0                                | 0    | 0     |   | 4                                | 0    | 0     |   | 0                    | 8    | 0     |   | 4                    | 8    | 0     |     | 24    |               |
| Pedestrians                     |                                  | 0    |       |   |                                  | 0    |       |   |                      | 0    |       |   |                      | 24   |       |     |       | 24            |
| Bicycles                        |                                  | 0    | 1     |   |                                  | 0    | 0     |   |                      | 0    | 0     |   |                      | 0    | 0     |     |       | 1             |
| Railroad                        |                                  |      |       |   |                                  |      |       |   |                      |      |       |   |                      |      |       |     |       |               |
| Stopped Buses                   |                                  |      |       |   |                                  |      |       |   |                      |      |       |   |                      |      |       |     |       |               |

Comments:

**LOCATION:** 7. Pacific Ave -- March Ln  
**CITY/STATE:** San Joaquin, CA

**QC JOB #:** 14437913  
**DATE:** Thu, Jun 01 2017

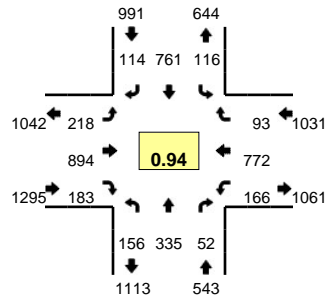

**Peak-Hour: 7:35 AM -- 8:35 AM**  
**Peak 15-Min: 7:45 AM -- 8:00 AM**

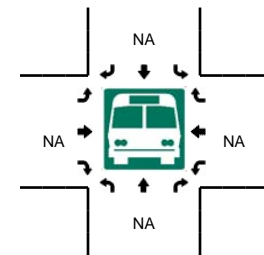
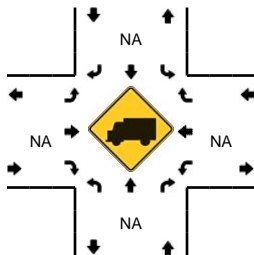
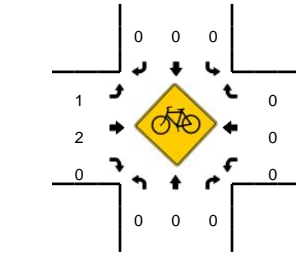
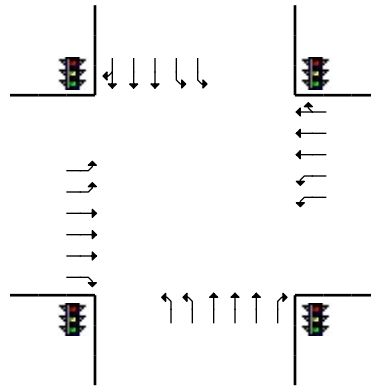
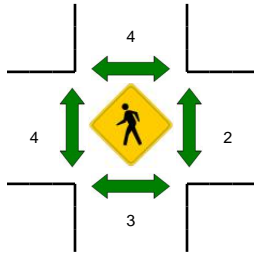
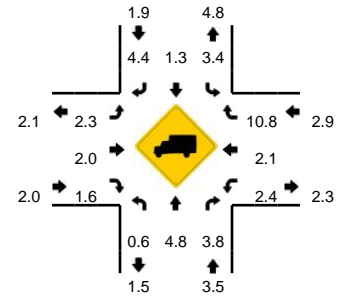

| 5-Min Count Period<br>Beginning At | 7. Pacific Ave (Northbound) |      |       |   | 7. Pacific Ave (Southbound) |      |       |   | March Ln (Eastbound) |      |       |   | March Ln (Westbound) |      |       |   | Total | Hourly Totals |
|------------------------------------|-----------------------------|------|-------|---|-----------------------------|------|-------|---|----------------------|------|-------|---|----------------------|------|-------|---|-------|---------------|
|                                    | Left                        | Thru | Right | U | Left                        | Thru | Right | U | Left                 | Thru | Right | U | Left                 | Thru | Right | U |       |               |
| 7:00 AM                            | 8                           | 9    | 2     | 1 | 1                           | 34   | 3     | 0 | 11                   | 34   | 9     | 0 | 12                   | 51   | 4     | 0 | 179   |               |
| 7:05 AM                            | 9                           | 20   | 1     | 0 | 2                           | 42   | 6     | 0 | 15                   | 51   | 8     | 0 | 11                   | 29   | 4     | 1 | 199   |               |
| 7:10 AM                            | 7                           | 10   | 2     | 0 | 10                          | 42   | 4     | 0 | 10                   | 46   | 10    | 0 | 11                   | 48   | 4     | 0 | 204   |               |
| 7:15 AM                            | 2                           | 15   | 1     | 2 | 1                           | 56   | 2     | 0 | 10                   | 30   | 10    | 0 | 13                   | 47   | 2     | 0 | 191   |               |
| 7:20 AM                            | 9                           | 29   | 1     | 0 | 8                           | 70   | 10    | 0 | 12                   | 69   | 12    | 0 | 11                   | 48   | 0     | 0 | 279   |               |
| 7:25 AM                            | 8                           | 20   | 2     | 1 | 7                           | 43   | 2     | 0 | 18                   | 75   | 22    | 0 | 6                    | 40   | 6     | 0 | 250   |               |
| 7:30 AM                            | 14                          | 21   | 2     | 0 | 5                           | 86   | 5     | 0 | 5                    | 68   | 19    | 0 | 11                   | 63   | 1     | 0 | 300   |               |
| 7:35 AM                            | 13                          | 40   | 3     | 1 | 5                           | 83   | 12    | 0 | 18                   | 44   | 17    | 0 | 15                   | 59   | 7     | 0 | 317   |               |
| 7:40 AM                            | 15                          | 31   | 2     | 0 | 12                          | 82   | 4     | 0 | 17                   | 78   | 22    | 0 | 10                   | 43   | 9     | 0 | 325   |               |
| 7:45 AM                            | 8                           | 28   | 5     | 1 | 4                           | 37   | 5     | 0 | 17                   | 95   | 25    | 1 | 13                   | 84   | 7     | 0 | 330   |               |
| 7:50 AM                            | 19                          | 21   | 5     | 0 | 8                           | 89   | 9     | 0 | 19                   | 56   | 11    | 0 | 16                   | 94   | 11    | 0 | 358   |               |
| 7:55 AM                            | 14                          | 32   | 4     | 1 | 11                          | 63   | 7     | 0 | 21                   | 83   | 12    | 0 | 27                   | 53   | 9     | 0 | 337   | 3269          |
| 8:00 AM                            | 20                          | 29   | 4     | 0 | 10                          | 65   | 7     | 0 | 26                   | 76   | 12    | 1 | 12                   | 53   | 5     | 0 | 320   | 3410          |
| 8:05 AM                            | 10                          | 25   | 7     | 0 | 8                           | 33   | 7     | 0 | 10                   | 85   | 15    | 1 | 8                    | 66   | 4     | 0 | 279   | 3490          |
| 8:10 AM                            | 11                          | 31   | 5     | 0 | 12                          | 86   | 13    | 0 | 16                   | 54   | 13    | 0 | 17                   | 68   | 6     | 0 | 332   | 3618          |
| 8:15 AM                            | 10                          | 32   | 3     | 0 | 12                          | 55   | 13    | 0 | 25                   | 86   | 19    | 0 | 7                    | 51   | 4     | 0 | 317   | 3744          |
| 8:20 AM                            | 11                          | 26   | 5     | 0 | 9                           | 63   | 14    | 0 | 24                   | 94   | 17    | 0 | 14                   | 66   | 11    | 0 | 354   | 3819          |
| 8:25 AM                            | 13                          | 14   | 4     | 0 | 6                           | 51   | 12    | 0 | 9                    | 76   | 12    | 0 | 12                   | 64   | 9     | 0 | 282   | 3851          |
| 8:30 AM                            | 9                           | 26   | 5     | 0 | 18                          | 54   | 11    | 1 | 13                   | 67   | 8     | 0 | 15                   | 71   | 11    | 0 | 309   | 3860          |
| 8:35 AM                            | 13                          | 26   | 2     | 0 | 10                          | 65   | 14    | 0 | 21                   | 74   | 18    | 1 | 10                   | 53   | 9     | 0 | 316   | 3859          |
| 8:40 AM                            | 6                           | 21   | 7     | 0 | 9                           | 30   | 18    | 1 | 20                   | 80   | 12    | 1 | 19                   | 81   | 10    | 0 | 315   | 3849          |
| 8:45 AM                            | 8                           | 25   | 2     | 0 | 12                          | 47   | 12    | 0 | 15                   | 59   | 5     | 0 | 20                   | 75   | 7     | 0 | 287   | 3806          |
| 8:50 AM                            | 17                          | 29   | 8     | 0 | 16                          | 61   | 13    | 1 | 22                   | 76   | 12    | 1 | 19                   | 63   | 10    | 0 | 348   | 3796          |
| 8:55 AM                            | 14                          | 39   | 3     | 0 | 7                           | 37   | 8     | 0 | 25                   | 90   | 16    | 0 | 11                   | 65   | 7     | 0 | 322   | 3781          |
| Peak 15-Min Flowrates              | Northbound                  |      |       |   | Southbound                  |      |       |   | Eastbound            |      |       |   | Westbound            |      |       |   | Total |               |
|                                    | Left                        | Thru | Right | U | Left                        | Thru | Right | U | Left                 | Thru | Right | U | Left                 | Thru | Right | U |       |               |
| All Vehicles                       | 164                         | 324  | 56    | 8 | 92                          | 756  | 84    | 0 | 228                  | 936  | 192   | 4 | 224                  | 924  | 108   | 0 | 4100  |               |
| Heavy Trucks                       | 0                           | 16   | 0     |   | 4                           | 12   | 4     |   | 0                    | 16   | 0     |   | 0                    | 16   | 8     |   | 76    |               |
| Pedestrians                        |                             | 8    |       |   |                             | 4    |       |   |                      | 4    |       |   |                      | 4    |       |   | 20    |               |
| Bicycles                           | 0                           | 0    | 0     |   | 0                           | 0    | 0     |   | 0                    | 0    | 0     |   | 0                    | 0    | 0     |   | 0     |               |
| Railroad                           |                             |      |       |   |                             |      |       |   |                      |      |       |   |                      |      |       |   |       |               |
| Stopped Buses                      |                             |      |       |   |                             |      |       |   |                      |      |       |   |                      |      |       |   |       |               |

Comments:

**LOCATION:** 7. Pacific Ave -- March Ln  
**CITY/STATE:** San Joaquin, CA

**QC JOB #:** 14437914  
**DATE:** Thu, Jun 01 2017

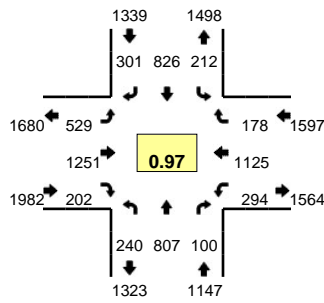

**Peak-Hour: 4:50 PM -- 5:50 PM**  
**Peak 15-Min: 5:05 PM -- 5:20 PM**

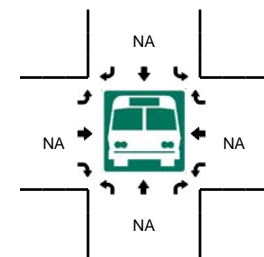
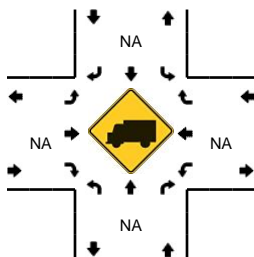
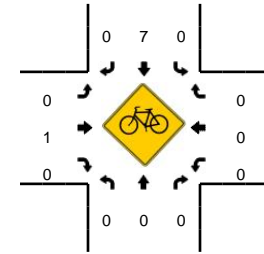
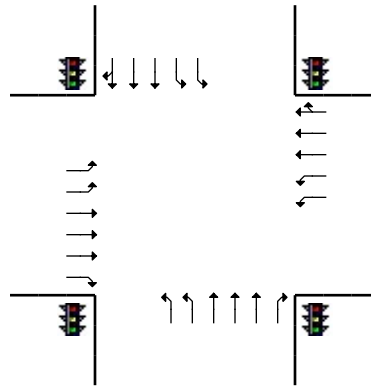
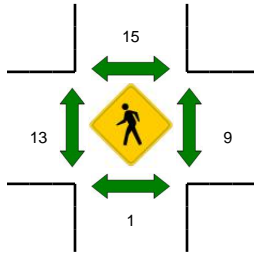
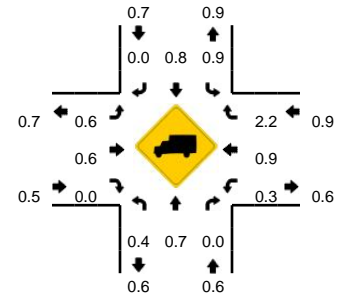

| 5-Min Count Period Beginning At | 7. Pacific Ave (Northbound) |      |       |   | 7. Pacific Ave (Southbound) |      |       |   | March Ln (Eastbound) |      |       |   | March Ln (Westbound) |      |       |   | Total | Hourly Totals |
|---------------------------------|-----------------------------|------|-------|---|-----------------------------|------|-------|---|----------------------|------|-------|---|----------------------|------|-------|---|-------|---------------|
|                                 | Left                        | Thru | Right | U | Left                        | Thru | Right | U | Left                 | Thru | Right | U | Left                 | Thru | Right | U |       |               |
| 4:00 PM                         | 19                          | 53   | 12    | 5 | 16                          | 46   | 23    | 0 | 40                   | 112  | 9     | 1 | 17                   | 73   | 7     | 0 | 433   |               |
| 4:05 PM                         | 29                          | 40   | 10    | 1 | 23                          | 58   | 23    | 0 | 38                   | 74   | 13    | 2 | 34                   | 119  | 14    | 1 | 479   |               |
| 4:10 PM                         | 13                          | 62   | 12    | 0 | 11                          | 41   | 21    | 0 | 56                   | 120  | 25    | 2 | 18                   | 84   | 8     | 0 | 473   |               |
| 4:15 PM                         | 27                          | 39   | 3     | 2 | 16                          | 80   | 25    | 1 | 30                   | 78   | 10    | 0 | 28                   | 124  | 10    | 0 | 473   |               |
| 4:20 PM                         | 17                          | 53   | 8     | 2 | 16                          | 35   | 23    | 2 | 41                   | 129  | 18    | 5 | 18                   | 82   | 11    | 0 | 460   |               |
| 4:25 PM                         | 27                          | 42   | 5     | 6 | 21                          | 63   | 32    | 1 | 27                   | 69   | 15    | 1 | 29                   | 112  | 13    | 0 | 463   |               |
| 4:30 PM                         | 21                          | 60   | 10    | 0 | 17                          | 46   | 25    | 0 | 64                   | 135  | 13    | 4 | 12                   | 82   | 7     | 0 | 496   |               |
| 4:35 PM                         | 24                          | 41   | 2     | 3 | 16                          | 72   | 29    | 0 | 39                   | 81   | 17    | 1 | 35                   | 99   | 15    | 2 | 476   |               |
| 4:40 PM                         | 17                          | 71   | 7     | 0 | 14                          | 48   | 30    | 0 | 55                   | 112  | 10    | 0 | 19                   | 74   | 11    | 0 | 468   |               |
| 4:45 PM                         | 20                          | 70   | 6     | 1 | 20                          | 62   | 24    | 1 | 37                   | 81   | 12    | 1 | 18                   | 130  | 9     | 0 | 492   |               |
| 4:50 PM                         | 22                          | 72   | 12    | 1 | 13                          | 49   | 17    | 0 | 50                   | 140  | 11    | 3 | 15                   | 74   | 8     | 1 | 488   |               |
| 4:55 PM                         | 16                          | 60   | 7     | 1 | 20                          | 78   | 32    | 1 | 34                   | 85   | 23    | 0 | 22                   | 109  | 15    | 0 | 503   | 5704          |
| 5:00 PM                         | 17                          | 75   | 12    | 2 | 14                          | 54   | 25    | 1 | 49                   | 117  | 17    | 3 | 12                   | 75   | 22    | 0 | 495   | 5766          |
| 5:05 PM                         | 16                          | 56   | 11    | 0 | 26                          | 91   | 31    | 0 | 32                   | 80   | 13    | 0 | 29                   | 102  | 30    | 0 | 517   | 5804          |
| 5:10 PM                         | 20                          | 88   | 5     | 0 | 16                          | 61   | 19    | 0 | 52                   | 138  | 21    | 1 | 11                   | 69   | 11    | 0 | 512   | 5843          |
| 5:15 PM                         | 27                          | 58   | 10    | 1 | 27                          | 77   | 35    | 0 | 32                   | 96   | 22    | 0 | 31                   | 104  | 15    | 0 | 535   | 5905          |
| 5:20 PM                         | 16                          | 93   | 8     | 0 | 13                          | 46   | 19    | 0 | 48                   | 123  | 13    | 5 | 17                   | 85   | 7     | 0 | 493   | 5938          |
| 5:25 PM                         | 31                          | 58   | 6     | 0 | 20                          | 70   | 32    | 2 | 36                   | 78   | 11    | 0 | 34                   | 121  | 18    | 1 | 518   | 5993          |
| 5:30 PM                         | 10                          | 76   | 6     | 0 | 11                          | 59   | 21    | 0 | 50                   | 125  | 19    | 3 | 22                   | 85   | 9     | 1 | 497   | 5994          |
| 5:35 PM                         | 20                          | 52   | 6     | 1 | 23                          | 101  | 16    | 0 | 34                   | 74   | 16    | 1 | 40                   | 103  | 19    | 0 | 506   | 6024          |
| 5:40 PM                         | 19                          | 79   | 7     | 0 | 8                           | 60   | 22    | 1 | 55                   | 120  | 21    | 4 | 19                   | 72   | 7     | 3 | 497   | 6053          |
| 5:45 PM                         | 19                          | 40   | 10    | 1 | 16                          | 80   | 32    | 0 | 36                   | 75   | 15    | 1 | 36                   | 126  | 17    | 0 | 504   | 6065          |
| 5:50 PM                         | 12                          | 56   | 8     | 0 | 13                          | 65   | 17    | 1 | 63                   | 89   | 13    | 1 | 22                   | 79   | 14    | 0 | 453   | 6030          |
| 5:55 PM                         | 14                          | 37   | 7     | 2 | 10                          | 85   | 30    | 1 | 35                   | 57   | 17    | 2 | 33                   | 119  | 13    | 2 | 464   | 5991          |
| Peak 15-Min Flowrates           | Northbound                  |      |       |   | Southbound                  |      |       |   | Eastbound            |      |       |   | Westbound            |      |       |   | Total |               |
|                                 | Left                        | Thru | Right | U | Left                        | Thru | Right | U | Left                 | Thru | Right | U | Left                 | Thru | Right | U |       |               |
| All Vehicles                    | 252                         | 808  | 104   | 4 | 276                         | 916  | 340   | 0 | 464                  | 1256 | 224   | 4 | 284                  | 1100 | 224   | 0 | 6256  |               |
| Heavy Trucks                    | 0                           | 4    | 0     |   | 4                           | 12   | 0     |   | 0                    | 4    | 0     |   | 4                    | 8    | 4     |   | 40    |               |
| Pedestrians                     |                             | 0    |       |   |                             | 8    |       |   |                      | 4    |       |   |                      | 12   |       |   | 24    |               |
| Bicycles                        | 0                           | 0    | 0     |   | 0                           | 0    | 0     |   | 0                    | 0    | 0     |   | 0                    | 0    | 0     |   | 0     |               |
| Railroad                        |                             |      |       |   |                             |      |       |   |                      |      |       |   |                      |      |       |   |       |               |
| Stopped Buses                   |                             |      |       |   |                             |      |       |   |                      |      |       |   |                      |      |       |   |       |               |

Comments:



**LOCATION:** 8. Pershing Ave -- Country Club Blvd  
**CITY/STATE:** San Joaquin, CA

**QC JOB #:** 14437915  
**DATE:** Thu, Jun 01 2017

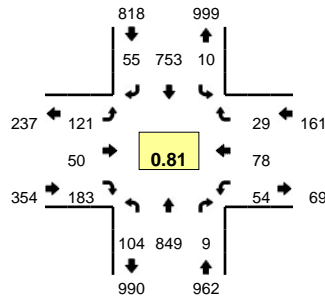

**Peak-Hour: 7:15 AM -- 8:15 AM**  
**Peak 15-Min: 7:45 AM -- 8:00 AM**

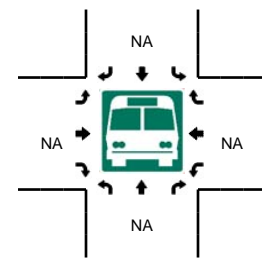
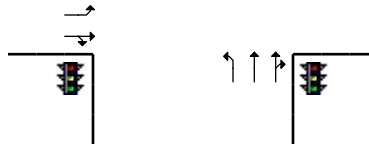
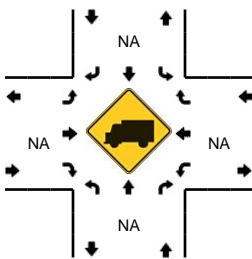
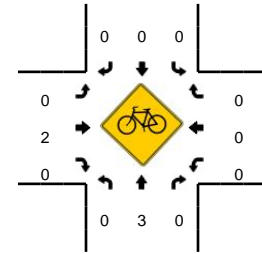
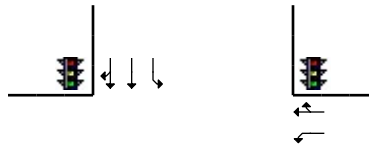
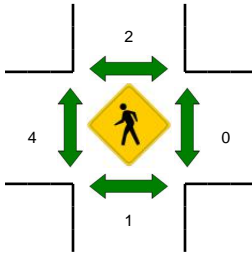
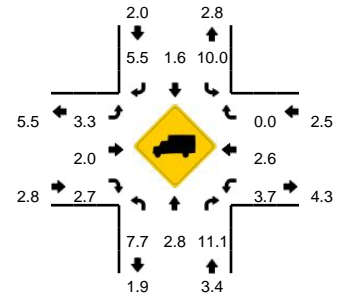

| 5-Min Count Period Beginning At | 8. Pershing Ave (Northbound) |      |       |   | 8. Pershing Ave (Southbound) |      |       |   | Country Club Blvd (Eastbound) |      |       |   | Country Club Blvd (Westbound) |      |       |   | Total | Hourly Totals |
|---------------------------------|------------------------------|------|-------|---|------------------------------|------|-------|---|-------------------------------|------|-------|---|-------------------------------|------|-------|---|-------|---------------|
|                                 | Left                         | Thru | Right | U | Left                         | Thru | Right | U | Left                          | Thru | Right | U | Left                          | Thru | Right | U |       |               |
| 7:00 AM                         | 1                            | 60   | 1     | 0 | 0                            | 34   | 1     | 0 | 10                            | 5    | 9     | 0 | 4                             | 3    | 2     | 0 | 130   |               |
| 7:05 AM                         | 2                            | 48   | 0     | 0 | 0                            | 49   | 2     | 0 | 9                             | 1    | 9     | 0 | 3                             | 4    | 1     | 0 | 128   |               |
| 7:10 AM                         | 8                            | 75   | 0     | 0 | 1                            | 47   | 5     | 0 | 13                            | 2    | 5     | 0 | 2                             | 3    | 1     | 0 | 162   |               |
| 7:15 AM                         | 6                            | 72   | 0     | 0 | 1                            | 61   | 4     | 0 | 13                            | 1    | 9     | 0 | 1                             | 4    | 1     | 0 | 173   |               |
| 7:20 AM                         | 6                            | 51   | 0     | 0 | 0                            | 54   | 5     | 0 | 9                             | 1    | 10    | 0 | 7                             | 6    | 1     | 0 | 150   |               |
| 7:25 AM                         | 12                           | 64   | 0     | 0 | 1                            | 54   | 3     | 0 | 7                             | 2    | 11    | 0 | 6                             | 5    | 0     | 0 | 165   |               |
| 7:30 AM                         | 13                           | 66   | 2     | 0 | 1                            | 52   | 5     | 0 | 6                             | 5    | 16    | 0 | 4                             | 4    | 3     | 0 | 177   |               |
| 7:35 AM                         | 5                            | 68   | 1     | 0 | 1                            | 74   | 2     | 0 | 12                            | 3    | 9     | 0 | 3                             | 6    | 3     | 0 | 187   |               |
| 7:40 AM                         | 12                           | 81   | 1     | 0 | 0                            | 59   | 4     | 0 | 12                            | 6    | 24    | 0 | 4                             | 8    | 7     | 0 | 218   |               |
| 7:45 AM                         | 9                            | 79   | 1     | 0 | 0                            | 87   | 5     | 0 | 10                            | 8    | 23    | 0 | 9                             | 4    | 6     | 0 | 241   |               |
| 7:50 AM                         | 10                           | 97   | 1     | 0 | 0                            | 72   | 7     | 0 | 12                            | 4    | 20    | 0 | 4                             | 13   | 3     | 0 | 243   |               |
| 7:55 AM                         | 7                            | 77   | 1     | 0 | 1                            | 81   | 7     | 0 | 9                             | 5    | 22    | 0 | 4                             | 6    | 2     | 0 | 222   | 2196          |
| 8:00 AM                         | 11                           | 57   | 1     | 0 | 3                            | 55   | 2     | 0 | 9                             | 6    | 16    | 0 | 2                             | 11   | 2     | 0 | 175   | 2241          |
| 8:05 AM                         | 7                            | 62   | 1     | 0 | 1                            | 48   | 5     | 0 | 14                            | 6    | 12    | 0 | 7                             | 8    | 1     | 0 | 172   | 2285          |
| 8:10 AM                         | 6                            | 75   | 0     | 0 | 1                            | 56   | 6     | 0 | 8                             | 3    | 11    | 0 | 3                             | 3    | 0     | 0 | 172   | 2295          |
| 8:15 AM                         | 5                            | 56   | 0     | 0 | 0                            | 47   | 1     | 0 | 12                            | 9    | 7     | 0 | 7                             | 6    | 2     | 0 | 152   | 2274          |
| 8:20 AM                         | 2                            | 69   | 0     | 0 | 2                            | 58   | 6     | 0 | 8                             | 5    | 8     | 0 | 2                             | 6    | 0     | 0 | 166   | 2290          |
| 8:25 AM                         | 12                           | 67   | 2     | 0 | 1                            | 51   | 3     | 0 | 2                             | 3    | 13    | 0 | 0                             | 2    | 2     | 0 | 158   | 2283          |
| 8:30 AM                         | 5                            | 53   | 0     | 0 | 4                            | 53   | 8     | 0 | 9                             | 0    | 10    | 0 | 3                             | 7    | 2     | 0 | 154   | 2260          |
| 8:35 AM                         | 6                            | 70   | 3     | 0 | 3                            | 47   | 3     | 0 | 13                            | 8    | 13    | 0 | 3                             | 3    | 2     | 0 | 174   | 2247          |
| 8:40 AM                         | 9                            | 71   | 2     | 0 | 1                            | 50   | 5     | 0 | 7                             | 5    | 10    | 0 | 3                             | 4    | 1     | 0 | 168   | 2197          |
| 8:45 AM                         | 8                            | 69   | 2     | 0 | 2                            | 37   | 3     | 0 | 8                             | 3    | 10    | 0 | 1                             | 2    | 2     | 0 | 147   | 2103          |
| 8:50 AM                         | 9                            | 58   | 0     | 0 | 1                            | 30   | 5     | 0 | 9                             | 5    | 15    | 0 | 2                             | 6    | 0     | 0 | 140   | 2000          |
| 8:55 AM                         | 8                            | 59   | 1     | 0 | 2                            | 26   | 8     | 0 | 7                             | 8    | 8     | 0 | 3                             | 3    | 1     | 0 | 134   | 1912          |
| Peak 15-Min Flowrates           | Northbound                   |      |       |   | Southbound                   |      |       |   | Eastbound                     |      |       |   | Westbound                     |      |       |   | Total |               |
|                                 | Left                         | Thru | Right | U | Left                         | Thru | Right | U | Left                          | Thru | Right | U | Left                          | Thru | Right | U |       |               |
| All Vehicles                    | 104                          | 1012 | 12    | 0 | 4                            | 960  | 76    | 0 | 124                           | 68   | 260   | 0 | 68                            | 92   | 44    | 0 | 2824  |               |
| Heavy Trucks                    | 12                           | 44   | 4     |   | 0                            | 12   | 8     |   | 8                             | 0    | 8     |   | 4                             | 8    | 0     |   | 108   |               |
| Pedestrians                     |                              | 0    |       |   |                              | 4    |       |   |                               | 4    |       |   |                               | 0    |       |   | 8     |               |
| Bicycles                        | 0                            | 0    | 0     |   | 0                            | 0    | 0     |   | 0                             | 1    | 0     |   | 0                             | 0    | 0     |   | 1     |               |
| Railroad                        |                              |      |       |   |                              |      |       |   |                               |      |       |   |                               |      |       |   |       |               |
| Stopped Buses                   |                              |      |       |   |                              |      |       |   |                               |      |       |   |                               |      |       |   |       |               |

Comments:

**LOCATION:** 8. Pershing Ave -- Country Club Blvd  
**CITY/STATE:** San Joaquin, CA

**QC JOB #:** 14437916  
**DATE:** Thu, Jun 01 2017

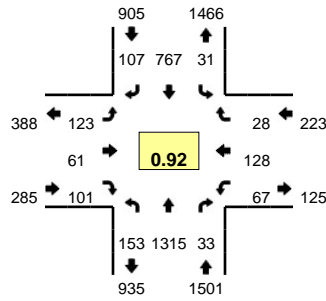

**Peak-Hour: 5:00 PM -- 6:00 PM**  
**Peak 15-Min: 5:30 PM -- 5:45 PM**

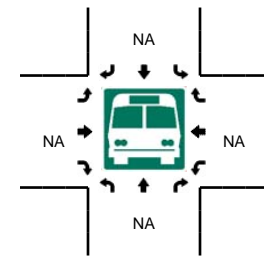
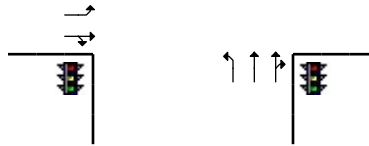
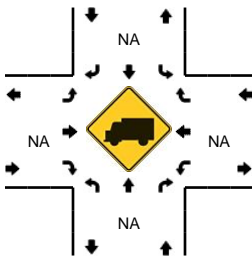
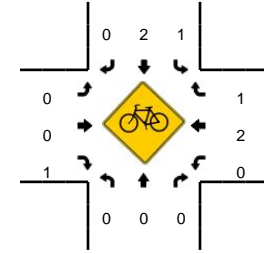
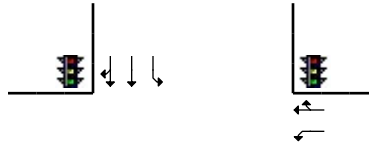
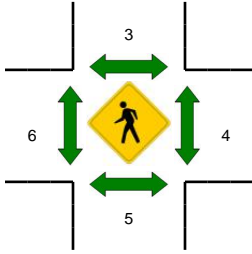
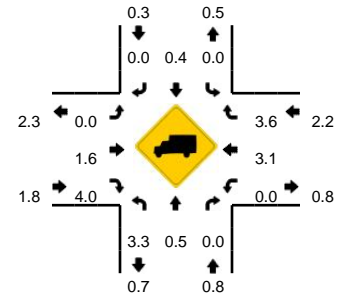

| 5-Min Count Period Beginning At | 8. Pershing Ave (Northbound) |      |       |   | 8. Pershing Ave (Southbound) |      |       |   | Country Club Blvd (Eastbound) |      |       |   | Country Club Blvd (Westbound) |      |       |   | Total | Hourly Totals |
|---------------------------------|------------------------------|------|-------|---|------------------------------|------|-------|---|-------------------------------|------|-------|---|-------------------------------|------|-------|---|-------|---------------|
|                                 | Left                         | Thru | Right | U | Left                         | Thru | Right | U | Left                          | Thru | Right | U | Left                          | Thru | Right | U |       |               |
| 4:00 PM                         | 7                            | 94   | 3     | 0 | 3                            | 68   | 18    | 0 | 13                            | 4    | 8     | 0 | 0                             | 6    | 1     | 0 | 225   |               |
| 4:05 PM                         | 16                           | 85   | 4     | 0 | 4                            | 47   | 4     | 0 | 5                             | 6    | 11    | 0 | 7                             | 12   | 1     | 0 | 202   |               |
| 4:10 PM                         | 10                           | 110  | 2     | 0 | 1                            | 78   | 8     | 0 | 6                             | 5    | 6     | 0 | 4                             | 8    | 2     | 0 | 240   |               |
| 4:15 PM                         | 15                           | 87   | 2     | 0 | 4                            | 53   | 4     | 0 | 10                            | 2    | 13    | 0 | 5                             | 14   | 3     | 0 | 212   |               |
| 4:20 PM                         | 9                            | 98   | 4     | 0 | 1                            | 80   | 15    | 0 | 8                             | 5    | 12    | 0 | 3                             | 2    | 5     | 0 | 242   |               |
| 4:25 PM                         | 14                           | 67   | 1     | 0 | 3                            | 36   | 3     | 0 | 12                            | 9    | 11    | 0 | 6                             | 10   | 2     | 0 | 174   |               |
| 4:30 PM                         | 12                           | 89   | 2     | 0 | 0                            | 74   | 14    | 0 | 6                             | 2    | 14    | 0 | 0                             | 4    | 0     | 0 | 217   |               |
| 4:35 PM                         | 10                           | 73   | 0     | 0 | 5                            | 48   | 9     | 0 | 12                            | 9    | 7     | 0 | 7                             | 9    | 4     | 0 | 193   |               |
| 4:40 PM                         | 13                           | 110  | 3     | 0 | 1                            | 83   | 10    | 0 | 6                             | 4    | 14    | 0 | 2                             | 9    | 0     | 0 | 255   |               |
| 4:45 PM                         | 10                           | 95   | 2     | 0 | 2                            | 45   | 6     | 0 | 15                            | 5    | 8     | 0 | 9                             | 12   | 3     | 0 | 212   |               |
| 4:50 PM                         | 8                            | 111  | 3     | 0 | 3                            | 58   | 7     | 0 | 2                             | 4    | 10    | 0 | 8                             | 9    | 2     | 0 | 225   |               |
| 4:55 PM                         | 8                            | 66   | 0     | 0 | 3                            | 54   | 5     | 0 | 15                            | 4    | 15    | 0 | 8                             | 14   | 5     | 0 | 197   | 2594          |
| 5:00 PM                         | 9                            | 106  | 2     | 0 | 2                            | 69   | 8     | 0 | 5                             | 2    | 8     | 0 | 3                             | 4    | 3     | 0 | 221   | 2590          |
| 5:05 PM                         | 12                           | 83   | 2     | 0 | 3                            | 64   | 14    | 0 | 11                            | 2    | 8     | 0 | 8                             | 13   | 1     | 0 | 221   | 2609          |
| 5:10 PM                         | 11                           | 133  | 3     | 0 | 2                            | 74   | 10    | 0 | 11                            | 6    | 2     | 0 | 1                             | 6    | 3     | 0 | 262   | 2631          |
| 5:15 PM                         | 13                           | 96   | 1     | 0 | 0                            | 71   | 8     | 0 | 10                            | 6    | 13    | 0 | 8                             | 17   | 1     | 0 | 244   | 2663          |
| 5:20 PM                         | 14                           | 112  | 6     | 0 | 1                            | 75   | 12    | 0 | 5                             | 4    | 7     | 0 | 6                             | 15   | 2     | 0 | 259   | 2680          |
| 5:25 PM                         | 14                           | 95   | 4     | 0 | 4                            | 39   | 7     | 0 | 13                            | 8    | 8     | 0 | 8                             | 16   | 2     | 0 | 218   | 2724          |
| 5:30 PM                         | 17                           | 126  | 2     | 0 | 2                            | 91   | 9     | 0 | 10                            | 7    | 8     | 0 | 7                             | 11   | 5     | 0 | 295   | 2802          |
| 5:35 PM                         | 11                           | 103  | 0     | 0 | 6                            | 51   | 5     | 0 | 17                            | 6    | 13    | 0 | 7                             | 12   | 1     | 0 | 232   | 2841          |
| 5:40 PM                         | 8                            | 146  | 4     | 0 | 2                            | 65   | 7     | 0 | 5                             | 5    | 6     | 0 | 4                             | 8    | 2     | 0 | 262   | 2848          |
| 5:45 PM                         | 14                           | 98   | 2     | 0 | 3                            | 65   | 6     | 0 | 14                            | 7    | 8     | 0 | 9                             | 12   | 2     | 0 | 240   | 2876          |
| 5:50 PM                         | 15                           | 127  | 2     | 0 | 0                            | 53   | 14    | 0 | 9                             | 4    | 10    | 0 | 1                             | 7    | 1     | 0 | 243   | 2894          |
| 5:55 PM                         | 15                           | 90   | 5     | 0 | 6                            | 50   | 7     | 0 | 13                            | 4    | 10    | 0 | 5                             | 7    | 5     | 0 | 217   | 2914          |
| Peak 15-Min Flowrates           | Northbound                   |      |       |   | Southbound                   |      |       |   | Eastbound                     |      |       |   | Westbound                     |      |       |   | Total |               |
|                                 | Left                         | Thru | Right | U | Left                         | Thru | Right | U | Left                          | Thru | Right | U | Left                          | Thru | Right | U |       |               |
| All Vehicles                    | 144                          | 1500 | 24    | 0 | 40                           | 828  | 84    | 0 | 128                           | 72   | 108   | 0 | 72                            | 124  | 32    | 0 | 3156  |               |
| Heavy Trucks                    | 0                            | 12   | 0     | 0 | 0                            | 4    | 0     | 0 | 0                             | 4    | 0     | 0 | 0                             | 4    | 0     | 0 | 24    |               |
| Pedestrians                     |                              | 4    |       |   |                              | 4    |       |   |                               | 0    |       |   |                               | 0    |       |   | 8     |               |
| Bicycles                        | 0                            | 0    | 0     |   | 0                            | 0    | 0     |   | 0                             | 0    | 0     |   | 0                             | 0    | 0     |   | 0     |               |
| Railroad                        |                              |      |       |   |                              |      |       |   |                               |      |       |   |                               |      |       |   |       |               |
| Stopped Buses                   |                              |      |       |   |                              |      |       |   |                               |      |       |   |                               |      |       |   |       |               |

Comments:

**LOCATION:** 9. El Dorado St -- Alpine Ave  
**CITY/STATE:** San Joaquin, CA

**QC JOB #:** 14437917  
**DATE:** Thu, Jun 01 2017

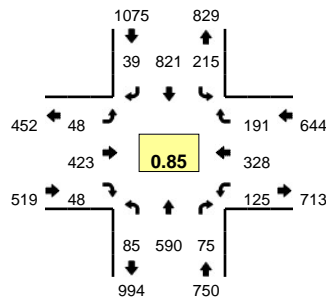

**Peak-Hour: 7:25 AM -- 8:25 AM**  
**Peak 15-Min: 7:35 AM -- 7:50 AM**

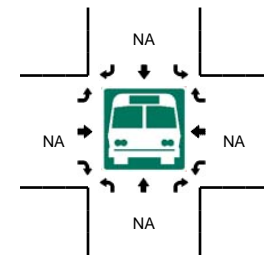
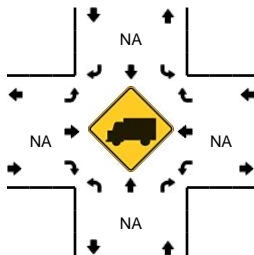
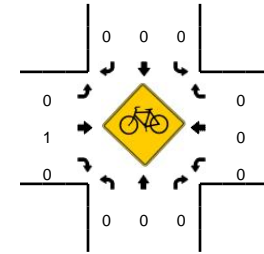
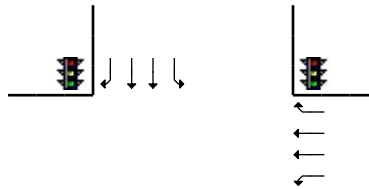
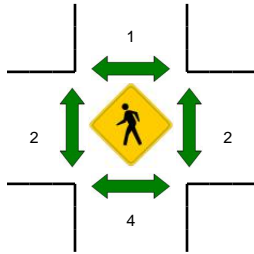
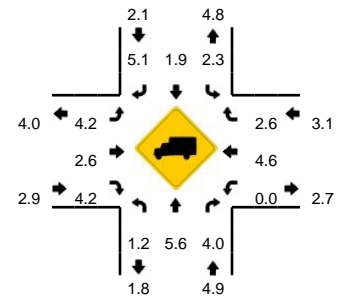

| 5-Min Count Period Beginning At | 9. El Dorado St (Northbound) |      |       |   | 9. El Dorado St (Southbound) |      |       |   | Alpine Ave (Eastbound) |      |       |   | Alpine Ave (Westbound) |      |       |   | Total | Hourly Totals |
|---------------------------------|------------------------------|------|-------|---|------------------------------|------|-------|---|------------------------|------|-------|---|------------------------|------|-------|---|-------|---------------|
|                                 | Left                         | Thru | Right | U | Left                         | Thru | Right | U | Left                   | Thru | Right | U | Left                   | Thru | Right | U |       |               |
| 7:00 AM                         | 3                            | 16   | 6     | 0 | 7                            | 41   | 1     | 0 | 1                      | 21   | 2     | 0 | 8                      | 13   | 7     | 0 | 126   |               |
| 7:05 AM                         | 3                            | 20   | 5     | 0 | 11                           | 43   | 3     | 0 | 1                      | 27   | 3     | 0 | 8                      | 15   | 5     | 0 | 144   |               |
| 7:10 AM                         | 5                            | 29   | 4     | 0 | 12                           | 45   | 1     | 0 | 0                      | 24   | 2     | 0 | 13                     | 23   | 7     | 0 | 165   |               |
| 7:15 AM                         | 7                            | 24   | 12    | 0 | 16                           | 59   | 6     | 0 | 0                      | 39   | 5     | 0 | 12                     | 22   | 10    | 0 | 212   |               |
| 7:20 AM                         | 5                            | 32   | 5     | 0 | 23                           | 71   | 3     | 0 | 2                      | 26   | 2     | 0 | 11                     | 24   | 11    | 0 | 215   |               |
| 7:25 AM                         | 8                            | 45   | 2     | 0 | 16                           | 73   | 2     | 0 | 0                      | 29   | 3     | 0 | 7                      | 24   | 15    | 0 | 224   |               |
| 7:30 AM                         | 8                            | 37   | 4     | 0 | 23                           | 53   | 3     | 0 | 4                      | 35   | 3     | 0 | 9                      | 29   | 19    | 0 | 227   |               |
| 7:35 AM                         | 7                            | 67   | 9     | 0 | 17                           | 72   | 1     | 0 | 2                      | 35   | 7     | 0 | 15                     | 40   | 20    | 0 | 292   |               |
| 7:40 AM                         | 8                            | 60   | 11    | 0 | 23                           | 102  | 6     | 0 | 3                      | 44   | 8     | 0 | 13                     | 19   | 15    | 0 | 312   |               |
| 7:45 AM                         | 6                            | 35   | 5     | 0 | 20                           | 95   | 5     | 0 | 3                      | 57   | 3     | 0 | 3                      | 29   | 16    | 0 | 277   |               |
| 7:50 AM                         | 8                            | 42   | 6     | 0 | 15                           | 82   | 3     | 0 | 6                      | 41   | 4     | 0 | 13                     | 27   | 18    | 0 | 265   |               |
| 7:55 AM                         | 9                            | 56   | 6     | 0 | 18                           | 75   | 4     | 0 | 5                      | 34   | 3     | 0 | 15                     | 31   | 13    | 0 | 269   | 2728          |
| 8:00 AM                         | 9                            | 58   | 6     | 0 | 14                           | 57   | 3     | 0 | 5                      | 35   | 2     | 0 | 10                     | 30   | 13    | 0 | 242   | 2844          |
| 8:05 AM                         | 4                            | 37   | 6     | 0 | 18                           | 54   | 6     | 0 | 4                      | 30   | 4     | 0 | 10                     | 35   | 18    | 0 | 226   | 2926          |
| 8:10 AM                         | 3                            | 49   | 6     | 0 | 13                           | 50   | 1     | 0 | 7                      | 31   | 4     | 0 | 8                      | 21   | 24    | 0 | 217   | 2978          |
| 8:15 AM                         | 6                            | 56   | 5     | 0 | 17                           | 58   | 2     | 0 | 3                      | 20   | 1     | 0 | 13                     | 23   | 8     | 0 | 212   | 2978          |
| 8:20 AM                         | 9                            | 48   | 9     | 0 | 21                           | 50   | 3     | 0 | 6                      | 32   | 6     | 0 | 9                      | 20   | 12    | 0 | 225   | 2988          |
| 8:25 AM                         | 7                            | 39   | 4     | 0 | 24                           | 47   | 2     | 0 | 4                      | 19   | 2     | 0 | 16                     | 33   | 14    | 0 | 211   | 2975          |
| 8:30 AM                         | 4                            | 50   | 4     | 0 | 12                           | 55   | 1     | 0 | 3                      | 15   | 1     | 0 | 15                     | 27   | 17    | 0 | 204   | 2952          |
| 8:35 AM                         | 3                            | 44   | 5     | 0 | 19                           | 61   | 3     | 0 | 3                      | 13   | 3     | 0 | 4                      | 16   | 11    | 0 | 185   | 2845          |
| 8:40 AM                         | 7                            | 39   | 8     | 0 | 14                           | 56   | 4     | 0 | 7                      | 25   | 1     | 0 | 14                     | 18   | 10    | 0 | 203   | 2736          |
| 8:45 AM                         | 6                            | 58   | 8     | 0 | 15                           | 34   | 0     | 0 | 3                      | 21   | 2     | 0 | 21                     | 36   | 20    | 0 | 224   | 2683          |
| 8:50 AM                         | 8                            | 69   | 9     | 0 | 15                           | 54   | 1     | 0 | 7                      | 16   | 2     | 0 | 15                     | 20   | 15    | 0 | 231   | 2649          |
| 8:55 AM                         | 3                            | 55   | 15    | 0 | 20                           | 55   | 3     | 0 | 1                      | 20   | 2     | 0 | 9                      | 16   | 13    | 0 | 212   | 2592          |
| Peak 15-Min Flowrates           | Northbound                   |      |       |   | Southbound                   |      |       |   | Eastbound              |      |       |   | Westbound              |      |       |   | Total |               |
|                                 | Left                         | Thru | Right | U | Left                         | Thru | Right | U | Left                   | Thru | Right | U | Left                   | Thru | Right | U |       |               |
| All Vehicles                    | 84                           | 648  | 100   | 0 | 240                          | 1076 | 48    | 0 | 32                     | 544  | 72    | 0 | 124                    | 352  | 204   | 0 | 3524  |               |
| Heavy Trucks                    | 0                            | 28   | 0     | 0 | 4                            | 20   | 4     | 0 | 0                      | 12   | 4     | 0 | 0                      | 12   | 4     | 0 | 88    |               |
| Pedestrians                     |                              | 8    |       |   |                              | 0    |       |   |                        | 0    |       |   |                        | 0    |       |   | 8     |               |
| Bicycles                        | 0                            | 0    | 0     | 0 | 0                            | 0    | 0     | 0 | 0                      | 0    | 0     | 0 | 0                      | 0    | 0     | 0 | 0     |               |
| Railroad                        |                              |      |       |   |                              |      |       |   |                        |      |       |   |                        |      |       |   | 0     |               |
| Stopped Buses                   |                              |      |       |   |                              |      |       |   |                        |      |       |   |                        |      |       |   |       |               |

Comments:

**LOCATION:** 9. El Dorado St -- Alpine Ave  
**CITY/STATE:** San Joaquin, CA

**QC JOB #:** 14437918  
**DATE:** Thu, Jun 01 2017

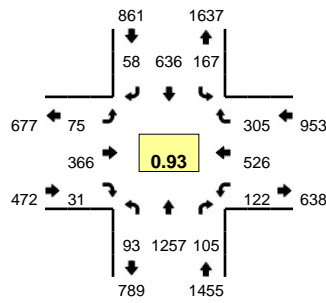

**Peak-Hour: 4:30 PM -- 5:30 PM**  
**Peak 15-Min: 5:10 PM -- 5:25 PM**

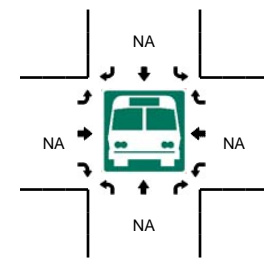
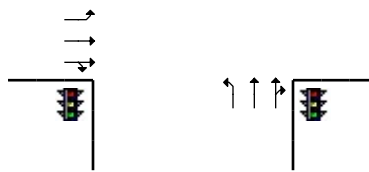
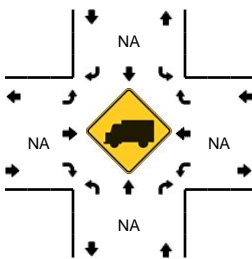
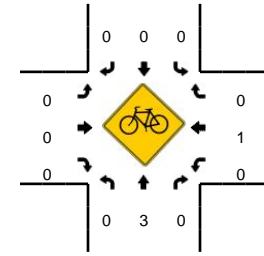
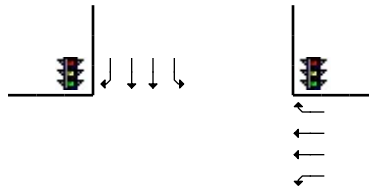
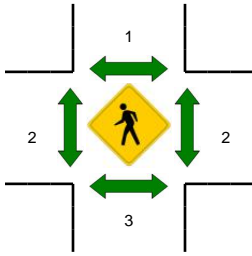
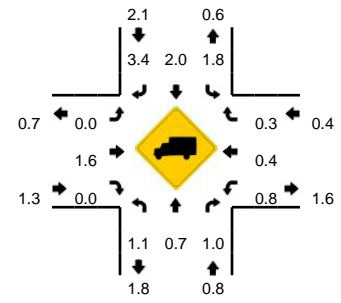

| 5-Min Count Period Beginning At | 9. El Dorado St (Northbound) |      |       |   | 9. El Dorado St (Southbound) |      |       |   | Alpine Ave (Eastbound) |      |       |   | Alpine Ave (Westbound) |      |       |   | Total | Hourly Totals |
|---------------------------------|------------------------------|------|-------|---|------------------------------|------|-------|---|------------------------|------|-------|---|------------------------|------|-------|---|-------|---------------|
|                                 | Left                         | Thru | Right | U | Left                         | Thru | Right | U | Left                   | Thru | Right | U | Left                   | Thru | Right | U |       |               |
| 4:00 PM                         | 6                            | 98   | 9     | 0 | 13                           | 71   | 1     | 0 | 7                      | 29   | 9     | 0 | 10                     | 46   | 30    | 0 | 329   |               |
| 4:05 PM                         | 8                            | 83   | 9     | 0 | 19                           | 53   | 5     | 0 | 7                      | 35   | 5     | 0 | 16                     | 46   | 29    | 0 | 315   |               |
| 4:10 PM                         | 7                            | 86   | 9     | 0 | 14                           | 50   | 4     | 0 | 6                      | 23   | 5     | 0 | 5                      | 23   | 24    | 0 | 256   |               |
| 4:15 PM                         | 4                            | 105  | 10    | 0 | 14                           | 56   | 2     | 0 | 3                      | 22   | 3     | 0 | 11                     | 33   | 17    | 0 | 280   |               |
| 4:20 PM                         | 6                            | 86   | 16    | 0 | 20                           | 67   | 3     | 0 | 11                     | 28   | 3     | 0 | 10                     | 37   | 24    | 0 | 311   |               |
| 4:25 PM                         | 6                            | 77   | 8     | 0 | 10                           | 50   | 5     | 0 | 5                      | 37   | 6     | 0 | 13                     | 33   | 27    | 0 | 277   |               |
| 4:30 PM                         | 7                            | 114  | 9     | 0 | 7                            | 51   | 5     | 0 | 1                      | 24   | 4     | 0 | 7                      | 40   | 26    | 0 | 295   |               |
| 4:35 PM                         | 6                            | 81   | 8     | 0 | 16                           | 54   | 5     | 0 | 11                     | 28   | 4     | 0 | 10                     | 37   | 28    | 0 | 288   |               |
| 4:40 PM                         | 7                            | 97   | 7     | 0 | 12                           | 48   | 4     | 0 | 10                     | 40   | 2     | 0 | 10                     | 52   | 22    | 0 | 311   |               |
| 4:45 PM                         | 8                            | 127  | 9     | 0 | 13                           | 65   | 8     | 0 | 7                      | 27   | 4     | 0 | 8                      | 43   | 20    | 0 | 339   |               |
| 4:50 PM                         | 8                            | 90   | 10    | 0 | 22                           | 61   | 6     | 0 | 4                      | 28   | 2     | 0 | 10                     | 30   | 24    | 0 | 295   |               |
| 4:55 PM                         | 7                            | 91   | 7     | 0 | 10                           | 44   | 4     | 0 | 9                      | 38   | 1     | 0 | 17                     | 52   | 27    | 0 | 307   | 3603          |
| 5:00 PM                         | 6                            | 112  | 12    | 0 | 11                           | 54   | 2     | 0 | 4                      | 25   | 6     | 0 | 7                      | 43   | 28    | 0 | 310   | 3584          |
| 5:05 PM                         | 10                           | 111  | 7     | 0 | 16                           | 56   | 3     | 0 | 3                      | 25   | 3     | 0 | 7                      | 36   | 28    | 0 | 305   | 3574          |
| 5:10 PM                         | 7                            | 102  | 4     | 0 | 14                           | 42   | 3     | 0 | 3                      | 30   | 3     | 0 | 15                     | 59   | 28    | 0 | 310   | 3628          |
| 5:15 PM                         | 15                           | 126  | 12    | 0 | 14                           | 63   | 7     | 0 | 8                      | 38   | 1     | 0 | 5                      | 49   | 26    | 0 | 364   | 3712          |
| 5:20 PM                         | 8                            | 116  | 16    | 0 | 17                           | 56   | 7     | 0 | 4                      | 28   | 1     | 0 | 12                     | 38   | 24    | 0 | 327   | 3728          |
| 5:25 PM                         | 4                            | 90   | 4     | 0 | 15                           | 42   | 4     | 0 | 11                     | 35   | 0     | 0 | 14                     | 47   | 24    | 0 | 290   | 3741          |
| 5:30 PM                         | 8                            | 85   | 14    | 0 | 11                           | 46   | 4     | 0 | 7                      | 21   | 2     | 0 | 7                      | 66   | 18    | 0 | 289   | 3735          |
| 5:35 PM                         | 7                            | 89   | 5     | 0 | 11                           | 57   | 3     | 0 | 6                      | 21   | 1     | 0 | 9                      | 40   | 13    | 0 | 262   | 3709          |
| 5:40 PM                         | 6                            | 85   | 7     | 0 | 16                           | 51   | 5     | 0 | 8                      | 27   | 6     | 0 | 13                     | 48   | 24    | 0 | 296   | 3694          |
| 5:45 PM                         | 2                            | 90   | 6     | 0 | 10                           | 52   | 2     | 0 | 4                      | 38   | 7     | 0 | 12                     | 56   | 28    | 0 | 307   | 3662          |
| 5:50 PM                         | 8                            | 71   | 12    | 0 | 5                            | 49   | 4     | 0 | 3                      | 25   | 3     | 0 | 5                      | 34   | 18    | 0 | 237   | 3604          |
| 5:55 PM                         | 6                            | 62   | 4     | 0 | 17                           | 29   | 4     | 0 | 7                      | 26   | 3     | 0 | 10                     | 50   | 24    | 0 | 242   | 3539          |
| Peak 15-Min Flowrates           | Northbound                   |      |       |   | Southbound                   |      |       |   | Eastbound              |      |       |   | Westbound              |      |       |   | Total |               |
|                                 | Left                         | Thru | Right | U | Left                         | Thru | Right | U | Left                   | Thru | Right | U | Left                   | Thru | Right | U |       |               |
| All Vehicles                    | 120                          | 1376 | 128   | 0 | 180                          | 644  | 68    | 0 | 60                     | 384  | 20    | 0 | 128                    | 584  | 312   | 0 | 4004  |               |
| Heavy Trucks                    | 0                            | 8    | 4     |   | 4                            | 12   | 0     |   | 0                      | 4    | 0     |   | 4                      | 4    | 0     |   | 40    |               |
| Pedestrians                     |                              | 8    |       |   |                              | 0    |       |   |                        | 4    |       |   |                        | 0    |       |   | 12    |               |
| Bicycles                        | 0                            | 0    | 0     |   | 0                            | 0    | 0     |   | 0                      | 0    | 0     |   | 0                      | 1    | 0     |   | 1     |               |
| Railroad                        |                              |      |       |   |                              |      |       |   |                        |      |       |   |                        |      |       |   |       |               |
| Stopped Buses                   |                              |      |       |   |                              |      |       |   |                        |      |       |   |                        |      |       |   |       |               |

Comments:

**LOCATION:** 10. Pacific Ave -- Harding Way  
**CITY/STATE:** San Joaquin, CA

**QC JOB #:** 14437919  
**DATE:** Thu, Jun 01 2017

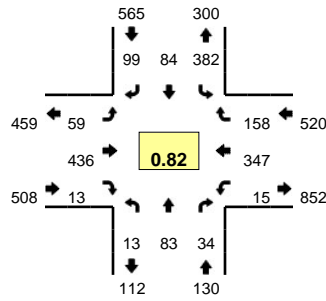

**Peak-Hour: 7:30 AM -- 8:30 AM**  
**Peak 15-Min: 7:45 AM -- 8:00 AM**

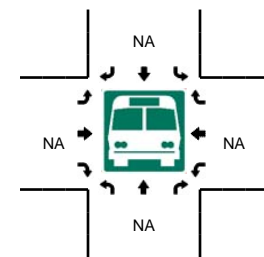
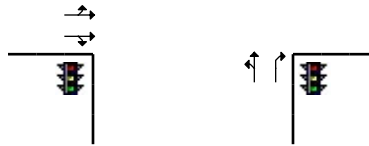
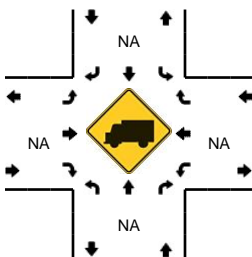
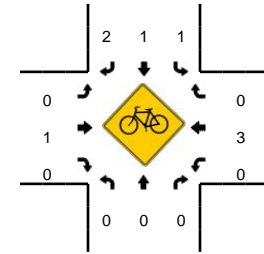
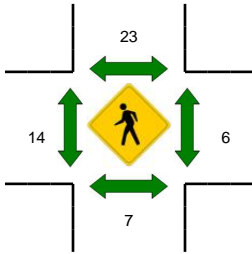
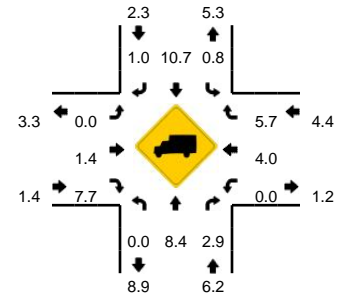

| 5-Min Count Period Beginning At | 10. Pacific Ave (Northbound) |      |       |   | 10. Pacific Ave (Southbound) |      |       |   | Harding Way (Eastbound) |      |       |   | Harding Way (Westbound) |      |       |   | Total | Hourly Totals |
|---------------------------------|------------------------------|------|-------|---|------------------------------|------|-------|---|-------------------------|------|-------|---|-------------------------|------|-------|---|-------|---------------|
|                                 | Left                         | Thru | Right | U | Left                         | Thru | Right | U | Left                    | Thru | Right | U | Left                    | Thru | Right | U |       |               |
| 7:00 AM                         | 0                            | 5    | 3     | 0 | 26                           | 7    | 3     | 0 | 1                       | 20   | 0     | 0 | 1                       | 10   | 4     | 0 | 80    |               |
| 7:05 AM                         | 3                            | 6    | 5     | 0 | 17                           | 3    | 6     | 0 | 5                       | 17   | 0     | 0 | 0                       | 10   | 8     | 0 | 80    |               |
| 7:10 AM                         | 0                            | 9    | 4     | 0 | 25                           | 4    | 6     | 0 | 2                       | 24   | 2     | 0 | 1                       | 30   | 10    | 0 | 117   |               |
| 7:15 AM                         | 1                            | 7    | 7     | 0 | 29                           | 6    | 8     | 0 | 5                       | 26   | 0     | 0 | 0                       | 16   | 9     | 0 | 114   |               |
| 7:20 AM                         | 0                            | 2    | 2     | 0 | 31                           | 8    | 5     | 0 | 3                       | 21   | 2     | 0 | 2                       | 31   | 4     | 0 | 111   |               |
| 7:25 AM                         | 0                            | 2    | 2     | 0 | 28                           | 8    | 7     | 0 | 3                       | 38   | 0     | 0 | 0                       | 20   | 9     | 0 | 117   |               |
| 7:30 AM                         | 0                            | 5    | 1     | 0 | 32                           | 4    | 8     | 0 | 5                       | 27   | 1     | 0 | 1                       | 33   | 6     | 0 | 123   |               |
| 7:35 AM                         | 1                            | 5    | 4     | 0 | 35                           | 5    | 6     | 0 | 6                       | 36   | 0     | 0 | 1                       | 16   | 10    | 0 | 125   |               |
| 7:40 AM                         | 1                            | 4    | 2     | 0 | 38                           | 7    | 5     | 0 | 3                       | 40   | 1     | 0 | 2                       | 39   | 15    | 0 | 157   |               |
| 7:45 AM                         | 2                            | 9    | 4     | 0 | 44                           | 7    | 11    | 0 | 6                       | 39   | 1     | 0 | 3                       | 42   | 16    | 0 | 184   |               |
| 7:50 AM                         | 0                            | 13   | 6     | 0 | 33                           | 7    | 8     | 0 | 3                       | 59   | 2     | 0 | 1                       | 35   | 14    | 0 | 181   |               |
| 7:55 AM                         | 2                            | 9    | 4     | 0 | 33                           | 6    | 7     | 0 | 4                       | 50   | 1     | 0 | 1                       | 26   | 16    | 0 | 159   | 1548          |
| 8:00 AM                         | 2                            | 10   | 2     | 0 | 24                           | 8    | 11    | 0 | 3                       | 32   | 0     | 0 | 3                       | 37   | 19    | 0 | 151   | 1619          |
| 8:05 AM                         | 0                            | 5    | 1     | 0 | 30                           | 8    | 9     | 0 | 7                       | 33   | 2     | 0 | 1                       | 26   | 17    | 0 | 139   | 1678          |
| 8:10 AM                         | 0                            | 8    | 1     | 0 | 24                           | 9    | 11    | 0 | 3                       | 35   | 0     | 0 | 1                       | 26   | 19    | 0 | 137   | 1698          |
| 8:15 AM                         | 3                            | 1    | 0     | 0 | 23                           | 5    | 5     | 0 | 6                       | 43   | 3     | 0 | 1                       | 30   | 14    | 0 | 134   | 1718          |
| 8:20 AM                         | 0                            | 8    | 6     | 0 | 34                           | 5    | 6     | 0 | 6                       | 20   | 1     | 0 | 0                       | 17   | 8     | 0 | 111   | 1718          |
| 8:25 AM                         | 2                            | 6    | 3     | 0 | 32                           | 13   | 12    | 0 | 7                       | 22   | 1     | 0 | 0                       | 20   | 4     | 0 | 122   | 1723          |
| 8:30 AM                         | 1                            | 6    | 1     | 0 | 23                           | 6    | 8     | 0 | 10                      | 25   | 1     | 0 | 0                       | 30   | 7     | 0 | 118   | 1718          |
| 8:35 AM                         | 1                            | 7    | 2     | 0 | 24                           | 6    | 5     | 0 | 2                       | 27   | 1     | 0 | 3                       | 33   | 8     | 0 | 119   | 1712          |
| 8:40 AM                         | 3                            | 12   | 4     | 0 | 30                           | 4    | 5     | 0 | 5                       | 32   | 2     | 0 | 1                       | 26   | 12    | 0 | 136   | 1691          |
| 8:45 AM                         | 1                            | 7    | 8     | 0 | 17                           | 5    | 6     | 0 | 6                       | 35   | 1     | 0 | 1                       | 35   | 10    | 0 | 132   | 1639          |
| 8:50 AM                         | 1                            | 4    | 4     | 0 | 27                           | 1    | 13    | 0 | 7                       | 23   | 1     | 0 | 0                       | 30   | 16    | 0 | 127   | 1585          |
| 8:55 AM                         | 1                            | 6    | 2     | 0 | 30                           | 6    | 10    | 0 | 3                       | 28   | 1     | 0 | 3                       | 25   | 19    | 0 | 134   | 1560          |
| Peak 15-Min Flowrates           | Northbound                   |      |       |   | Southbound                   |      |       |   | Eastbound               |      |       |   | Westbound               |      |       |   | Total |               |
|                                 | Left                         | Thru | Right | U | Left                         | Thru | Right | U | Left                    | Thru | Right | U | Left                    | Thru | Right | U |       |               |
| All Vehicles                    | 16                           | 124  | 56    | 0 | 440                          | 80   | 104   | 0 | 52                      | 592  | 16    | 0 | 20                      | 412  | 184   | 0 | 2096  |               |
| Heavy Trucks                    | 0                            | 4    | 0     |   | 0                            | 4    | 0     |   | 0                       | 0    | 0     |   | 0                       | 8    | 12    |   | 28    |               |
| Pedestrians                     |                              | 20   |       |   |                              | 24   |       |   |                         | 20   |       |   |                         | 4    |       |   | 68    |               |
| Bicycles                        | 0                            | 0    | 0     |   | 0                            | 0    | 1     |   | 0                       | 0    | 0     |   | 0                       | 3    | 0     |   | 4     |               |
| Railroad                        |                              |      |       |   |                              |      |       |   |                         |      |       |   |                         |      |       |   |       |               |
| Stopped Buses                   |                              |      |       |   |                              |      |       |   |                         |      |       |   |                         |      |       |   |       |               |

Comments:

**LOCATION:** 10. Pacific Ave -- Harding Way  
**CITY/STATE:** San Joaquin, CA

**QC JOB #:** 14437920  
**DATE:** Thu, Jun 01 2017

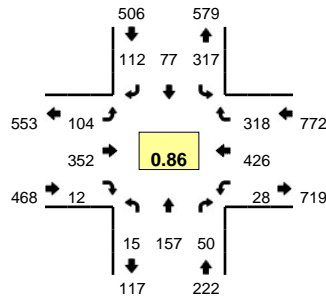

**Peak-Hour: 4:25 PM -- 5:25 PM**  
**Peak 15-Min: 5:05 PM -- 5:20 PM**

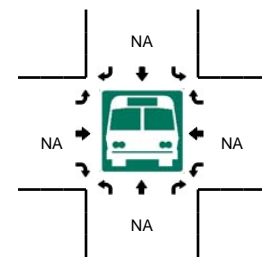
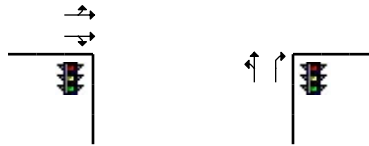
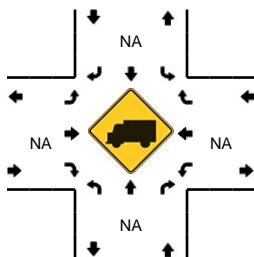
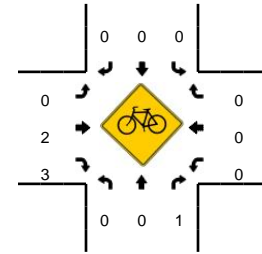
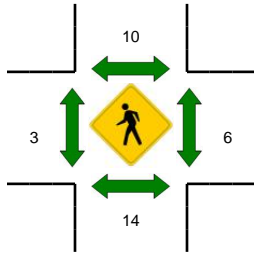
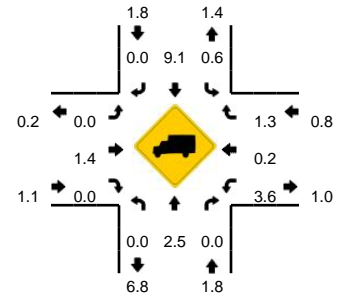

| 5-Min Count Period Beginning At | 10. Pacific Ave (Northbound) |      |       |   | 10. Pacific Ave (Southbound) |      |       |   | Harding Way (Eastbound) |      |       |   | Harding Way (Westbound) |      |       |   | Total | Hourly Totals |
|---------------------------------|------------------------------|------|-------|---|------------------------------|------|-------|---|-------------------------|------|-------|---|-------------------------|------|-------|---|-------|---------------|
|                                 | Left                         | Thru | Right | U | Left                         | Thru | Right | U | Left                    | Thru | Right | U | Left                    | Thru | Right | U |       |               |
| 4:00 PM                         | 2                            | 8    | 5     | 0 | 30                           | 6    | 12    | 0 | 3                       | 34   | 2     | 0 | 2                       | 28   | 22    | 0 | 154   |               |
| 4:05 PM                         | 2                            | 11   | 2     | 0 | 18                           | 5    | 12    | 0 | 3                       | 25   | 1     | 0 | 1                       | 30   | 33    | 0 | 143   |               |
| 4:10 PM                         | 3                            | 9    | 2     | 0 | 22                           | 12   | 6     | 0 | 10                      | 35   | 1     | 0 | 1                       | 32   | 27    | 0 | 160   |               |
| 4:15 PM                         | 1                            | 6    | 5     | 0 | 21                           | 7    | 6     | 0 | 9                       | 28   | 5     | 0 | 3                       | 34   | 34    | 0 | 159   |               |
| 4:20 PM                         | 0                            | 9    | 3     | 0 | 34                           | 4    | 14    | 0 | 6                       | 22   | 1     | 1 | 1                       | 32   | 27    | 0 | 154   |               |
| 4:25 PM                         | 1                            | 6    | 4     | 0 | 24                           | 5    | 5     | 0 | 10                      | 28   | 2     | 0 | 1                       | 40   | 29    | 0 | 155   |               |
| 4:30 PM                         | 1                            | 10   | 6     | 0 | 21                           | 11   | 10    | 0 | 5                       | 31   | 1     | 0 | 3                       | 18   | 26    | 0 | 143   |               |
| 4:35 PM                         | 1                            | 25   | 7     | 0 | 18                           | 6    | 11    | 0 | 5                       | 33   | 1     | 0 | 1                       | 37   | 20    | 0 | 165   |               |
| 4:40 PM                         | 4                            | 12   | 7     | 0 | 27                           | 5    | 4     | 0 | 4                       | 25   | 1     | 0 | 3                       | 36   | 28    | 0 | 156   |               |
| 4:45 PM                         | 0                            | 9    | 2     | 0 | 24                           | 6    | 10    | 0 | 12                      | 35   | 0     | 0 | 1                       | 27   | 27    | 0 | 153   |               |
| 4:50 PM                         | 1                            | 8    | 4     | 0 | 27                           | 3    | 8     | 0 | 10                      | 22   | 1     | 0 | 1                       | 39   | 29    | 0 | 153   |               |
| 4:55 PM                         | 0                            | 10   | 6     | 0 | 34                           | 8    | 11    | 0 | 11                      | 32   | 2     | 0 | 1                       | 37   | 18    | 0 | 170   | 1865          |
| 5:00 PM                         | 1                            | 19   | 3     | 0 | 14                           | 3    | 11    | 0 | 13                      | 31   | 1     | 0 | 2                       | 25   | 20    | 0 | 143   | 1854          |
| 5:05 PM                         | 2                            | 16   | 3     | 0 | 35                           | 5    | 14    | 0 | 11                      | 33   | 0     | 0 | 5                       | 45   | 28    | 0 | 197   | 1908          |
| 5:10 PM                         | 1                            | 18   | 3     | 0 | 47                           | 12   | 8     | 0 | 9                       | 29   | 1     | 0 | 1                       | 40   | 36    | 0 | 205   | 1953          |
| 5:15 PM                         | 2                            | 18   | 3     | 0 | 28                           | 3    | 11    | 0 | 5                       | 28   | 1     | 0 | 5                       | 37   | 30    | 0 | 171   | 1965          |
| 5:20 PM                         | 1                            | 6    | 2     | 0 | 18                           | 10   | 9     | 0 | 9                       | 25   | 1     | 0 | 4                       | 45   | 27    | 0 | 157   | 1968          |
| 5:25 PM                         | 2                            | 10   | 1     | 0 | 20                           | 8    | 14    | 0 | 8                       | 27   | 1     | 0 | 2                       | 33   | 29    | 0 | 155   | 1968          |
| 5:30 PM                         | 1                            | 12   | 2     | 0 | 18                           | 6    | 16    | 0 | 2                       | 31   | 1     | 0 | 0                       | 26   | 26    | 0 | 141   | 1966          |
| 5:35 PM                         | 1                            | 9    | 4     | 0 | 24                           | 9    | 8     | 0 | 10                      | 20   | 3     | 0 | 1                       | 36   | 23    | 0 | 148   | 1949          |
| 5:40 PM                         | 3                            | 13   | 0     | 0 | 33                           | 7    | 11    | 0 | 5                       | 28   | 2     | 0 | 3                       | 30   | 30    | 0 | 165   | 1958          |
| 5:45 PM                         | 0                            | 6    | 2     | 0 | 29                           | 8    | 18    | 0 | 9                       | 27   | 0     | 0 | 3                       | 36   | 19    | 0 | 157   | 1962          |
| 5:50 PM                         | 0                            | 12   | 4     | 0 | 21                           | 9    | 9     | 0 | 10                      | 27   | 0     | 0 | 0                       | 33   | 10    | 0 | 135   | 1944          |
| 5:55 PM                         | 2                            | 13   | 2     | 0 | 23                           | 7    | 14    | 0 | 3                       | 15   | 0     | 0 | 0                       | 23   | 20    | 0 | 122   | 1896          |
| Peak 15-Min Flowrates           | Northbound                   |      |       |   | Southbound                   |      |       |   | Eastbound               |      |       |   | Westbound               |      |       |   | Total |               |
|                                 | Left                         | Thru | Right | U | Left                         | Thru | Right | U | Left                    | Thru | Right | U | Left                    | Thru | Right | U |       |               |
| All Vehicles                    | 20                           | 208  | 36    | 0 | 440                          | 80   | 132   | 0 | 100                     | 360  | 8     | 0 | 44                      | 488  | 376   | 0 | 2292  |               |
| Heavy Trucks                    | 0                            | 4    | 0     |   | 4                            | 8    | 0     |   | 0                       | 0    | 0     |   | 0                       | 4    | 4     |   | 24    |               |
| Pedestrians                     |                              | 4    |       |   | 16                           |      |       |   |                         | 8    |       |   |                         | 4    |       |   | 32    |               |
| Bicycles                        | 0                            | 0    | 0     |   | 0                            | 0    | 0     |   | 0                       | 0    | 2     |   | 0                       | 0    | 0     |   | 2     |               |
| Railroad                        |                              |      |       |   |                              |      |       |   |                         |      |       |   |                         |      |       |   |       |               |
| Stopped Buses                   |                              |      |       |   |                              |      |       |   |                         |      |       |   |                         |      |       |   |       |               |

Comments:



Location: West Ln & Harding Way

Date: 6/1/2017

Site Code: 14437921

| Start Time   | West Ln Southbound    |            |             |            |          | Harding Way Westbound |                       |             |           |          | Airport Way Northbound |            |                      |            |          | Harding Way Eastbound |            |            |                      |          | Berkeley Ave Southeastbound |                      |                     |                 |          |
|--------------|-----------------------|------------|-------------|------------|----------|-----------------------|-----------------------|-------------|-----------|----------|------------------------|------------|----------------------|------------|----------|-----------------------|------------|------------|----------------------|----------|-----------------------------|----------------------|---------------------|-----------------|----------|
|              | Right to Berkeley Ave | Right      | Thru        | Left       | U-Turns  | Right                 | Right to Berkeley Ave | Thru        | Left      | U-Turns  | Right                  | Thru       | Left to Berkeley Ave | Left       | U-Turns  | Right                 | Thru       | Left       | Left to Berkeley Ave | U-Turns  | Right to Harding Way        | Right to Airport Way | Left to Harding Way | Left to West Ln | U-Turns  |
| 07:00 AM     | 0                     | 6          | 24          | 3          | 0        | 2                     | 0                     | 26          | 3         | 0        | 0                      | 12         | 0                    | 4          | 0        | 8                     | 23         | 2          | 0                    | 0        | 0                           | 0                    | 1                   | 0               | 0        |
| 07:05 AM     | 1                     | 11         | 44          | 2          | 0        | 7                     | 0                     | 17          | 3         | 0        | 1                      | 29         | 0                    | 8          | 0        | 3                     | 17         | 6          | 0                    | 0        | 1                           | 2                    | 0                   | 0               | 0        |
| 07:10 AM     | 0                     | 6          | 39          | 2          | 0        | 4                     | 0                     | 31          | 0         | 0        | 0                      | 15         | 0                    | 4          | 0        | 5                     | 26         | 8          | 0                    | 0        | 2                           | 0                    | 0                   | 0               | 1        |
| 07:15 AM     | 0                     | 7          | 56          | 5          | 0        | 6                     | 0                     | 30          | 3         | 0        | 2                      | 31         | 0                    | 12         | 0        | 1                     | 17         | 2          | 0                    | 0        | 0                           | 1                    | 0                   | 0               | 0        |
| 07:20 AM     | 0                     | 10         | 39          | 10         | 0        | 5                     | 0                     | 38          | 1         | 0        | 1                      | 34         | 0                    | 3          | 0        | 2                     | 21         | 10         | 0                    | 0        | 1                           | 0                    | 0                   | 0               | 0        |
| 07:25 AM     | 1                     | 8          | 48          | 6          | 0        | 5                     | 0                     | 40          | 3         | 0        | 2                      | 31         | 0                    | 13         | 0        | 8                     | 24         | 4          | 0                    | 0        | 2                           | 1                    | 0                   | 0               | 0        |
| 07:30 AM     | 0                     | 9          | 36          | 7          | 0        | 4                     | 0                     | 51          | 2         | 0        | 0                      | 25         | 0                    | 6          | 0        | 10                    | 34         | 16         | 1                    | 0        | 3                           | 0                    | 0                   | 0               | 0        |
| 07:35 AM     | 0                     | 19         | 35          | 10         | 0        | 3                     | 0                     | 49          | 0         | 0        | 1                      | 47         | 0                    | 14         | 0        | 13                    | 27         | 20         | 1                    | 0        | 4                           | 0                    | 0                   | 0               | 0        |
| 07:40 AM     | 0                     | 27         | 86          | 4          | 0        | 4                     | 0                     | 64          | 4         | 0        | 3                      | 56         | 0                    | 8          | 0        | 9                     | 33         | 11         | 0                    | 0        | 2                           | 1                    | 0                   | 0               | 0        |
| 07:45 AM     | 0                     | 19         | 49          | 5          | 0        | 5                     | 0                     | 57          | 7         | 0        | 1                      | 57         | 0                    | 12         | 0        | 12                    | 35         | 28         | 1                    | 0        | 3                           | 1                    | 0                   | 0               | 0        |
| 07:50 AM     | 0                     | 12         | 35          | 4          | 0        | 6                     | 0                     | 91          | 3         | 0        | 3                      | 41         | 0                    | 7          | 0        | 12                    | 48         | 19         | 0                    | 0        | 4                           | 0                    | 0                   | 0               | 0        |
| 07:55 AM     | 0                     | 23         | 64          | 19         | 0        | 5                     | 0                     | 60          | 2         | 0        | 2                      | 61         | 0                    | 22         | 0        | 13                    | 27         | 19         | 0                    | 0        | 9                           | 0                    | 0                   | 0               | 0        |
| 08:00 AM     | 0                     | 25         | 78          | 9          | 0        | 4                     | 0                     | 32          | 3         | 0        | 1                      | 70         | 0                    | 4          | 0        | 5                     | 29         | 20         | 2                    | 0        | 1                           | 0                    | 0                   | 0               | 0        |
| 08:05 AM     | 0                     | 10         | 39          | 10         | 0        | 10                    | 0                     | 56          | 1         | 0        | 4                      | 29         | 0                    | 10         | 0        | 5                     | 48         | 15         | 0                    | 0        | 3                           | 0                    | 0                   | 0               | 0        |
| 08:10 AM     | 1                     | 11         | 39          | 9          | 0        | 8                     | 0                     | 30          | 4         | 0        | 2                      | 47         | 0                    | 6          | 0        | 5                     | 28         | 11         | 1                    | 0        | 2                           | 0                    | 0                   | 0               | 0        |
| 08:15 AM     | 0                     | 9          | 19          | 3          | 0        | 6                     | 0                     | 32          | 0         | 0        | 3                      | 36         | 0                    | 7          | 0        | 7                     | 22         | 12         | 0                    | 0        | 2                           | 1                    | 0                   | 0               | 0        |
| 08:20 AM     | 0                     | 2          | 36          | 4          | 0        | 10                    | 0                     | 37          | 1         | 0        | 4                      | 47         | 0                    | 9          | 0        | 8                     | 13         | 8          | 0                    | 0        | 1                           | 1                    | 0                   | 0               | 0        |
| 08:25 AM     | 0                     | 10         | 63          | 6          | 0        | 5                     | 0                     | 38          | 3         | 0        | 3                      | 38         | 0                    | 9          | 0        | 5                     | 28         | 13         | 0                    | 0        | 0                           | 0                    | 0                   | 0               | 0        |
| 08:30 AM     | 0                     | 10         | 45          | 7          | 0        | 6                     | 0                     | 46          | 2         | 0        | 3                      | 28         | 0                    | 7          | 0        | 5                     | 24         | 5          | 0                    | 0        | 0                           | 0                    | 0                   | 0               | 0        |
| 08:35 AM     | 0                     | 9          | 50          | 6          | 0        | 3                     | 0                     | 27          | 1         | 0        | 2                      | 34         | 0                    | 9          | 0        | 4                     | 29         | 15         | 0                    | 0        | 2                           | 0                    | 0                   | 0               | 0        |
| 08:40 AM     | 1                     | 5          | 33          | 3          | 1        | 4                     | 0                     | 45          | 3         | 0        | 0                      | 36         | 0                    | 10         | 0        | 10                    | 31         | 6          | 0                    | 0        | 2                           | 0                    | 0                   | 0               | 0        |
| 08:45 AM     | 1                     | 10         | 59          | 5          | 0        | 6                     | 0                     | 35          | 2         | 0        | 2                      | 37         | 0                    | 9          | 0        | 7                     | 28         | 15         | 0                    | 0        | 1                           | 0                    | 0                   | 0               | 0        |
| 08:50 AM     | 1                     | 8          | 38          | 16         | 0        | 10                    | 0                     | 43          | 0         | 0        | 1                      | 18         | 0                    | 13         | 0        | 7                     | 30         | 7          | 1                    | 0        | 1                           | 1                    | 0                   | 0               | 0        |
| 08:55 AM     | 0                     | 15         | 31          | 7          | 0        | 4                     | 0                     | 26          | 3         | 0        | 5                      | 28         | 0                    | 6          | 0        | 6                     | 32         | 11         | 0                    | 0        | 0                           | 0                    | 0                   | 0               | 0        |
| <b>Total</b> | <b>6</b>              | <b>281</b> | <b>1085</b> | <b>162</b> | <b>1</b> | <b>132</b>            | <b>0</b>              | <b>1001</b> | <b>54</b> | <b>0</b> | <b>46</b>              | <b>887</b> | <b>0</b>             | <b>212</b> | <b>0</b> | <b>170</b>            | <b>674</b> | <b>283</b> | <b>7</b>             | <b>0</b> | <b>46</b>                   | <b>10</b>            | <b>0</b>            | <b>0</b>        | <b>1</b> |

Peak Hour: 7:30 AM - 8:30 AM

Peak 15: 7:45 AM - 8:00 AM

PHF: 0.816722



Location: West Ln & Harding Way

Date: 6/1/2017

Site Code: 14437922

| Start Time   | West Ln Southbound    |            |             |            |          | Harding Way Westbound |                       |            |           |          | Airport Way Northbound |             |                      |            |          | Harding Way Eastbound |             |            |                      |          | Berkeley Ave Southeastbound |                      |                     |                 |          |
|--------------|-----------------------|------------|-------------|------------|----------|-----------------------|-----------------------|------------|-----------|----------|------------------------|-------------|----------------------|------------|----------|-----------------------|-------------|------------|----------------------|----------|-----------------------------|----------------------|---------------------|-----------------|----------|
|              | Right to Berkeley Ave | Right      | Thru        | Left       | U-Turns  | Right                 | Right to Berkeley Ave | Thru       | Left      | U-Turns  | Right                  | Thru        | Left to Berkeley Ave | Left       | U-Turns  | Right                 | Thru        | Left       | Left to Berkeley Ave | U-Turns  | Right to Harding Way        | Right to Airport Way | Left to Harding Way | Left to West Ln | U-Turns  |
| 04:00 PM     | 0                     | 10         | 47          | 12         | 0        | 13                    | 0                     | 46         | 3         | 0        | 1                      | 42          | 0                    | 7          | 0        | 13                    | 47          | 19         | 0                    | 0        | 0                           | 0                    | 0                   | 0               | 0        |
| 04:05 PM     | 0                     | 11         | 59          | 11         | 0        | 10                    | 0                     | 33         | 5         | 0        | 5                      | 69          | 0                    | 15         | 0        | 10                    | 47          | 18         | 0                    | 0        | 1                           | 0                    | 0                   | 0               | 0        |
| 04:10 PM     | 0                     | 17         | 62          | 10         | 0        | 7                     | 0                     | 41         | 2         | 0        | 4                      | 75          | 0                    | 9          | 0        | 12                    | 42          | 9          | 0                    | 0        | 1                           | 4                    | 0                   | 0               | 1        |
| 04:15 PM     | 0                     | 12         | 47          | 15         | 0        | 14                    | 0                     | 52         | 2         | 0        | 3                      | 54          | 0                    | 4          | 0        | 9                     | 49          | 25         | 0                    | 0        | 2                           | 2                    | 0                   | 0               | 0        |
| 04:20 PM     | 0                     | 10         | 44          | 14         | 0        | 8                     | 0                     | 45         | 1         | 0        | 4                      | 63          | 0                    | 15         | 0        | 12                    | 38          | 12         | 0                    | 0        | 3                           | 2                    | 0                   | 0               | 0        |
| 04:25 PM     | 0                     | 7          | 42          | 23         | 0        | 9                     | 0                     | 34         | 2         | 0        | 9                      | 51          | 0                    | 17         | 0        | 17                    | 49          | 12         | 0                    | 0        | 2                           | 1                    | 0                   | 0               | 0        |
| 04:30 PM     | 0                     | 16         | 60          | 12         | 0        | 7                     | 0                     | 31         | 1         | 0        | 4                      | 74          | 0                    | 14         | 0        | 4                     | 36          | 16         | 0                    | 0        | 2                           | 0                    | 0                   | 0               | 0        |
| 04:35 PM     | 1                     | 7          | 31          | 8          | 0        | 11                    | 0                     | 46         | 4         | 0        | 8                      | 53          | 0                    | 12         | 0        | 7                     | 84          | 19         | 1                    | 0        | 0                           | 0                    | 0                   | 1               | 0        |
| 04:40 PM     | 1                     | 8          | 47          | 14         | 0        | 15                    | 0                     | 47         | 1         | 0        | 5                      | 59          | 0                    | 9          | 0        | 7                     | 54          | 11         | 1                    | 0        | 1                           | 1                    | 0                   | 0               | 0        |
| 04:45 PM     | 0                     | 6          | 51          | 12         | 0        | 6                     | 0                     | 37         | 2         | 0        | 3                      | 59          | 0                    | 11         | 0        | 8                     | 36          | 14         | 0                    | 0        | 3                           | 0                    | 0                   | 0               | 0        |
| 04:50 PM     | 0                     | 13         | 47          | 13         | 0        | 7                     | 0                     | 41         | 2         | 0        | 5                      | 79          | 0                    | 10         | 0        | 12                    | 51          | 10         | 0                    | 0        | 2                           | 1                    | 0                   | 0               | 0        |
| 04:55 PM     | 0                     | 13         | 31          | 1          | 0        | 8                     | 0                     | 36         | 3         | 0        | 5                      | 43          | 0                    | 10         | 0        | 8                     | 40          | 17         | 0                    | 0        | 2                           | 2                    | 0                   | 0               | 0        |
| 05:00 PM     | 0                     | 10         | 66          | 18         | 0        | 5                     | 0                     | 40         | 3         | 0        | 2                      | 43          | 0                    | 5          | 0        | 11                    | 72          | 22         | 1                    | 0        | 1                           | 1                    | 0                   | 0               | 0        |
| 05:05 PM     | 0                     | 8          | 19          | 8          | 0        | 12                    | 0                     | 47         | 2         | 0        | 9                      | 59          | 0                    | 10         | 0        | 5                     | 70          | 20         | 0                    | 0        | 2                           | 0                    | 0                   | 0               | 1        |
| 05:10 PM     | 0                     | 9          | 72          | 25         | 0        | 13                    | 0                     | 32         | 0         | 0        | 4                      | 65          | 0                    | 15         | 0        | 12                    | 59          | 13         | 0                    | 0        | 4                           | 0                    | 0                   | 0               | 0        |
| 05:15 PM     | 0                     | 7          | 45          | 15         | 0        | 9                     | 0                     | 39         | 4         | 0        | 4                      | 74          | 0                    | 13         | 0        | 12                    | 58          | 17         | 0                    | 0        | 3                           | 0                    | 0                   | 0               | 0        |
| 05:20 PM     | 0                     | 20         | 37          | 11         | 0        | 12                    | 0                     | 37         | 2         | 0        | 4                      | 77          | 0                    | 14         | 0        | 6                     | 50          | 14         | 1                    | 0        | 6                           | 0                    | 0                   | 0               | 0        |
| 05:25 PM     | 0                     | 8          | 52          | 13         | 0        | 9                     | 0                     | 33         | 1         | 0        | 4                      | 51          | 0                    | 10         | 0        | 7                     | 41          | 11         | 0                    | 0        | 3                           | 0                    | 0                   | 0               | 0        |
| 05:30 PM     | 0                     | 19         | 55          | 12         | 0        | 8                     | 0                     | 36         | 1         | 0        | 3                      | 70          | 0                    | 6          | 0        | 8                     | 34          | 8          | 0                    | 0        | 3                           | 3                    | 0                   | 0               | 0        |
| 05:35 PM     | 0                     | 8          | 31          | 11         | 0        | 12                    | 0                     | 37         | 1         | 0        | 4                      | 38          | 0                    | 8          | 0        | 9                     | 44          | 10         | 0                    | 0        | 1                           | 0                    | 0                   | 0               | 0        |
| 05:40 PM     | 1                     | 7          | 64          | 7          | 0        | 7                     | 0                     | 27         | 3         | 0        | 2                      | 62          | 2                    | 5          | 0        | 4                     | 33          | 19         | 0                    | 0        | 2                           | 0                    | 0                   | 0               | 0        |
| 05:45 PM     | 0                     | 5          | 19          | 7          | 0        | 8                     | 1                     | 45         | 5         | 0        | 1                      | 45          | 0                    | 7          | 0        | 12                    | 71          | 8          | 0                    | 0        | 2                           | 0                    | 0                   | 1               | 0        |
| 05:50 PM     | 1                     | 10         | 52          | 17         | 0        | 5                     | 0                     | 38         | 1         | 0        | 1                      | 44          | 0                    | 12         | 0        | 7                     | 37          | 8          | 1                    | 0        | 1                           | 0                    | 0                   | 0               | 0        |
| 05:55 PM     | 0                     | 11         | 45          | 15         | 0        | 9                     | 0                     | 30         | 1         | 0        | 5                      | 67          | 1                    | 8          | 0        | 2                     | 26          | 9          | 1                    | 0        | 3                           | 0                    | 0                   | 0               | 0        |
| <b>Total</b> | <b>4</b>              | <b>252</b> | <b>1125</b> | <b>304</b> | <b>0</b> | <b>224</b>            | <b>1</b>              | <b>930</b> | <b>52</b> | <b>0</b> | <b>99</b>              | <b>1416</b> | <b>3</b>             | <b>246</b> | <b>0</b> | <b>214</b>            | <b>1168</b> | <b>341</b> | <b>6</b>             | <b>0</b> | <b>50</b>                   | <b>17</b>            | <b>0</b>            | <b>0</b>        | <b>2</b> |

Peak Hour: 4:25 PM - 5:25 PM

Peak 15: 5:10 PM - 5:25 PM

PHF: 0.922319



**LOCATION:** 12. Fresno Ave -- Charter Way  
**CITY/STATE:** San Joaquin, CA

**QC JOB #:** 14437923  
**DATE:** Thu, Jun 01 2017

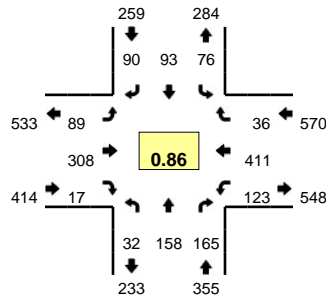

**Peak-Hour: 7:00 AM -- 8:00 AM**  
**Peak 15-Min: 7:30 AM -- 7:45 AM**

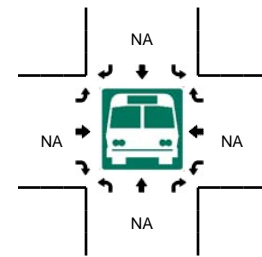
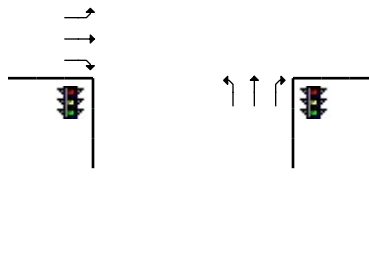
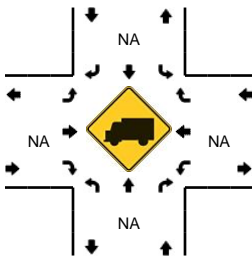
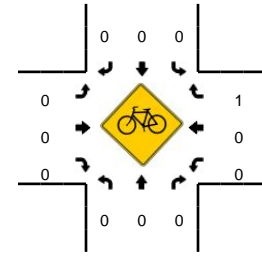
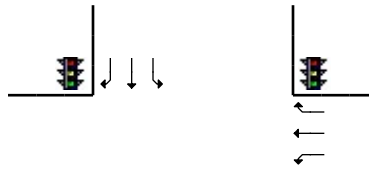
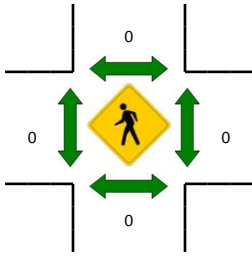
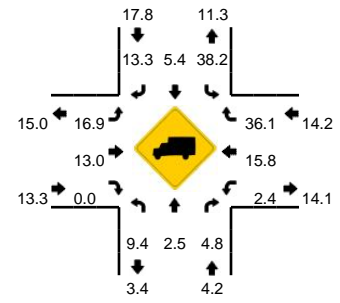

| 5-Min Count Period Beginning At | 12. Fresno Ave (Northbound) |      |       |   | 12. Fresno Ave (Southbound) |      |       |   | Charter Way (Eastbound) |      |       |   | Charter Way (Westbound) |      |       |   | Total | Hourly Totals |
|---------------------------------|-----------------------------|------|-------|---|-----------------------------|------|-------|---|-------------------------|------|-------|---|-------------------------|------|-------|---|-------|---------------|
|                                 | Left                        | Thru | Right | U | Left                        | Thru | Right | U | Left                    | Thru | Right | U | Left                    | Thru | Right | U |       |               |
| 7:00 AM                         | 1                           | 1    | 14    | 0 | 4                           | 4    | 6     | 0 | 7                       | 20   | 1     | 0 | 8                       | 35   | 3     | 0 | 104   |               |
| 7:05 AM                         | 2                           | 9    | 13    | 0 | 4                           | 6    | 17    | 0 | 2                       | 8    | 0     | 0 | 6                       | 40   | 2     | 0 | 109   |               |
| 7:10 AM                         | 2                           | 3    | 17    | 0 | 8                           | 2    | 7     | 0 | 12                      | 40   | 1     | 0 | 5                       | 38   | 4     | 0 | 139   |               |
| 7:15 AM                         | 4                           | 17   | 13    | 0 | 8                           | 3    | 7     | 0 | 3                       | 12   | 0     | 0 | 13                      | 29   | 2     | 0 | 111   |               |
| 7:20 AM                         | 3                           | 19   | 11    | 0 | 4                           | 5    | 7     | 0 | 10                      | 24   | 1     | 0 | 15                      | 33   | 4     | 0 | 136   |               |
| 7:25 AM                         | 5                           | 13   | 9     | 0 | 6                           | 11   | 5     | 0 | 9                       | 25   | 1     | 0 | 7                       | 36   | 6     | 0 | 133   |               |
| 7:30 AM                         | 1                           | 19   | 16    | 0 | 8                           | 23   | 8     | 1 | 6                       | 26   | 2     | 0 | 22                      | 24   | 1     | 0 | 157   |               |
| 7:35 AM                         | 3                           | 13   | 19    | 0 | 3                           | 9    | 3     | 0 | 14                      | 33   | 1     | 0 | 10                      | 32   | 3     | 0 | 143   |               |
| 7:40 AM                         | 5                           | 18   | 19    | 0 | 9                           | 11   | 9     | 0 | 10                      | 29   | 4     | 0 | 17                      | 33   | 3     | 0 | 167   |               |
| 7:45 AM                         | 1                           | 20   | 12    | 0 | 8                           | 12   | 7     | 0 | 4                       | 32   | 1     | 0 | 9                       | 39   | 2     | 0 | 147   |               |
| 7:50 AM                         | 3                           | 14   | 10    | 0 | 6                           | 5    | 5     | 0 | 10                      | 30   | 1     | 0 | 3                       | 43   | 2     | 0 | 132   |               |
| 7:55 AM                         | 2                           | 12   | 12    | 0 | 7                           | 2    | 9     | 0 | 2                       | 29   | 4     | 0 | 8                       | 29   | 4     | 0 | 120   | 1598          |
| 8:00 AM                         | 8                           | 5    | 6     | 0 | 6                           | 7    | 6     | 0 | 3                       | 19   | 1     | 0 | 4                       | 35   | 2     | 0 | 102   | 1596          |
| 8:05 AM                         | 3                           | 7    | 8     | 0 | 5                           | 7    | 3     | 0 | 6                       | 25   | 0     | 0 | 12                      | 30   | 4     | 0 | 110   | 1597          |
| 8:10 AM                         | 3                           | 8    | 8     | 0 | 6                           | 4    | 7     | 0 | 4                       | 21   | 1     | 0 | 9                       | 38   | 2     | 0 | 111   | 1569          |
| 8:15 AM                         | 1                           | 7    | 7     | 0 | 5                           | 6    | 9     | 0 | 10                      | 34   | 1     | 0 | 7                       | 24   | 5     | 0 | 116   | 1574          |
| 8:20 AM                         | 0                           | 4    | 7     | 0 | 6                           | 3    | 10    | 0 | 8                       | 24   | 3     | 0 | 15                      | 33   | 4     | 0 | 117   | 1555          |
| 8:25 AM                         | 1                           | 4    | 6     | 0 | 8                           | 5    | 6     | 0 | 7                       | 15   | 1     | 0 | 8                       | 36   | 3     | 0 | 100   | 1522          |
| 8:30 AM                         | 1                           | 11   | 7     | 0 | 4                           | 7    | 6     | 0 | 6                       | 27   | 2     | 0 | 4                       | 25   | 4     | 0 | 104   | 1469          |
| 8:35 AM                         | 2                           | 3    | 8     | 0 | 12                          | 2    | 4     | 0 | 13                      | 34   | 0     | 0 | 5                       | 35   | 2     | 0 | 120   | 1446          |
| 8:40 AM                         | 0                           | 7    | 11    | 0 | 12                          | 1    | 5     | 0 | 9                       | 23   | 1     | 0 | 2                       | 32   | 4     | 0 | 107   | 1386          |
| 8:45 AM                         | 0                           | 11   | 9     | 0 | 8                           | 2    | 4     | 0 | 7                       | 28   | 0     | 0 | 6                       | 30   | 4     | 0 | 109   | 1348          |
| 8:50 AM                         | 3                           | 2    | 5     | 0 | 9                           | 6    | 6     | 0 | 11                      | 31   | 0     | 0 | 4                       | 24   | 6     | 0 | 107   | 1323          |
| 8:55 AM                         | 1                           | 8    | 8     | 0 | 8                           | 2    | 8     | 0 | 8                       | 19   | 0     | 0 | 5                       | 28   | 5     | 0 | 100   | 1303          |
| Peak 15-Min Flowrates           | Northbound                  |      |       |   | Southbound                  |      |       |   | Eastbound               |      |       |   | Westbound               |      |       |   | Total |               |
|                                 | Left                        | Thru | Right | U | Left                        | Thru | Right | U | Left                    | Thru | Right | U | Left                    | Thru | Right | U |       |               |
| All Vehicles                    | 36                          | 200  | 216   | 0 | 80                          | 172  | 80    | 4 | 120                     | 352  | 28    | 0 | 196                     | 356  | 28    | 0 | 1868  |               |
| Heavy Trucks                    | 4                           | 4    | 12    |   | 32                          | 8    | 8     |   | 4                       | 20   | 0     |   | 4                       | 60   | 12    |   | 168   |               |
| Pedestrians                     |                             | 0    |       |   |                             | 0    |       |   |                         | 0    |       |   |                         | 0    |       |   | 0     |               |
| Bicycles                        | 0                           | 0    | 0     |   | 0                           | 0    | 0     |   | 0                       | 0    | 0     |   | 0                       | 0    | 0     |   | 0     |               |
| Railroad                        |                             |      |       |   |                             |      |       |   |                         |      |       |   |                         |      |       |   |       |               |
| Stopped Buses                   |                             |      |       |   |                             |      |       |   |                         |      |       |   |                         |      |       |   |       |               |

Comments:

**LOCATION:** 12. Fresno Ave -- Charter Way  
**CITY/STATE:** San Joaquin, CA

**QC JOB #:** 14437924  
**DATE:** Thu, Jun 01 2017

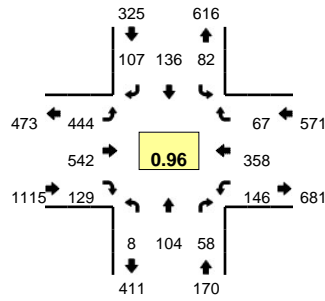

**Peak-Hour: 4:20 PM -- 5:20 PM**  
**Peak 15-Min: 4:25 PM -- 4:40 PM**

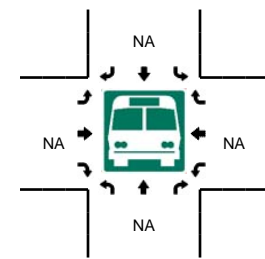
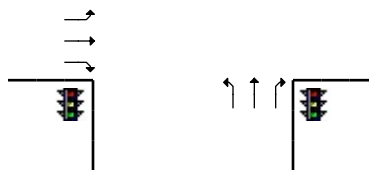
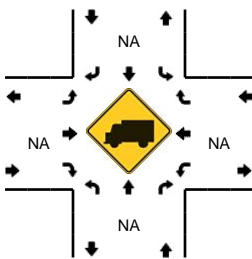
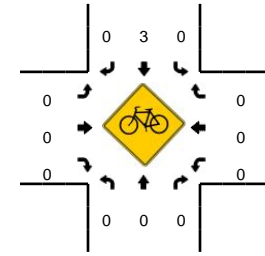
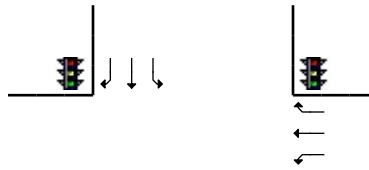
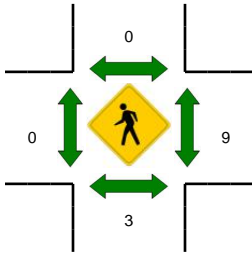
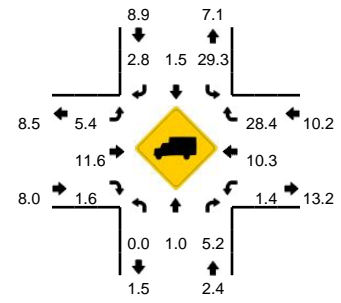

| 5-Min Count Period Beginning At | 12. Fresno Ave (Northbound) |      |       |   | 12. Fresno Ave (Southbound) |      |       |   | Charter Way (Eastbound) |      |       |   | Charter Way (Westbound) |      |       |   | Total | Hourly Totals |
|---------------------------------|-----------------------------|------|-------|---|-----------------------------|------|-------|---|-------------------------|------|-------|---|-------------------------|------|-------|---|-------|---------------|
|                                 | Left                        | Thru | Right | U | Left                        | Thru | Right | U | Left                    | Thru | Right | U | Left                    | Thru | Right | U |       |               |
| 4:00 PM                         | 0                           | 11   | 7     | 0 | 1                           | 6    | 3     | 0 | 39                      | 43   | 13    | 0 | 19                      | 25   | 12    | 0 | 179   |               |
| 4:05 PM                         | 1                           | 9    | 7     | 0 | 5                           | 10   | 7     | 0 | 50                      | 50   | 11    | 0 | 5                       | 14   | 8     | 0 | 177   |               |
| 4:10 PM                         | 1                           | 9    | 6     | 0 | 8                           | 10   | 7     | 0 | 45                      | 42   | 6     | 0 | 13                      | 28   | 5     | 0 | 180   |               |
| 4:15 PM                         | 4                           | 6    | 2     | 0 | 4                           | 5    | 8     | 0 | 44                      | 45   | 12    | 0 | 18                      | 32   | 3     | 0 | 183   |               |
| 4:20 PM                         | 0                           | 7    | 6     | 0 | 7                           | 13   | 12    | 1 | 30                      | 47   | 14    | 0 | 8                       | 33   | 3     | 0 | 181   |               |
| 4:25 PM                         | 0                           | 12   | 5     | 0 | 4                           | 8    | 8     | 0 | 35                      | 44   | 2     | 0 | 18                      | 35   | 5     | 0 | 176   |               |
| 4:30 PM                         | 2                           | 9    | 6     | 0 | 8                           | 8    | 11    | 0 | 52                      | 50   | 10    | 0 | 13                      | 25   | 4     | 0 | 198   |               |
| 4:35 PM                         | 0                           | 7    | 4     | 0 | 8                           | 12   | 8     | 0 | 44                      | 55   | 9     | 0 | 11                      | 29   | 5     | 0 | 192   |               |
| 4:40 PM                         | 0                           | 12   | 5     | 0 | 11                          | 11   | 8     | 0 | 24                      | 36   | 10    | 0 | 15                      | 36   | 2     | 0 | 170   |               |
| 4:45 PM                         | 0                           | 10   | 9     | 0 | 11                          | 12   | 13    | 0 | 35                      | 46   | 9     | 0 | 9                       | 30   | 8     | 0 | 192   |               |
| 4:50 PM                         | 0                           | 8    | 4     | 0 | 2                           | 14   | 12    | 0 | 28                      | 48   | 15    | 0 | 17                      | 30   | 6     | 0 | 184   |               |
| 4:55 PM                         | 0                           | 7    | 7     | 0 | 8                           | 13   | 5     | 0 | 28                      | 48   | 9     | 0 | 8                       | 30   | 5     | 0 | 168   | 2180          |
| 5:00 PM                         | 2                           | 9    | 3     | 0 | 6                           | 9    | 5     | 0 | 30                      | 48   | 14    | 0 | 7                       | 18   | 11    | 0 | 162   | 2163          |
| 5:05 PM                         | 1                           | 6    | 2     | 0 | 6                           | 10   | 4     | 0 | 48                      | 29   | 11    | 0 | 10                      | 26   | 7     | 0 | 160   | 2146          |
| 5:10 PM                         | 2                           | 11   | 3     | 0 | 4                           | 13   | 7     | 0 | 45                      | 47   | 11    | 0 | 15                      | 30   | 9     | 0 | 197   | 2163          |
| 5:15 PM                         | 1                           | 6    | 4     | 0 | 6                           | 13   | 14    | 0 | 45                      | 44   | 15    | 0 | 15                      | 36   | 2     | 0 | 201   | 2181          |
| 5:20 PM                         | 2                           | 7    | 7     | 0 | 8                           | 13   | 9     | 0 | 20                      | 52   | 8     | 0 | 16                      | 33   | 2     | 0 | 177   | 2177          |
| 5:25 PM                         | 1                           | 7    | 6     | 0 | 2                           | 13   | 8     | 0 | 24                      | 47   | 8     | 0 | 10                      | 20   | 3     | 0 | 149   | 2150          |
| 5:30 PM                         | 1                           | 7    | 9     | 0 | 11                          | 14   | 11    | 0 | 28                      | 41   | 3     | 0 | 13                      | 20   | 6     | 0 | 164   | 2116          |
| 5:35 PM                         | 3                           | 7    | 4     | 0 | 4                           | 14   | 9     | 0 | 28                      | 47   | 6     | 0 | 20                      | 20   | 3     | 0 | 165   | 2089          |
| 5:40 PM                         | 2                           | 5    | 6     | 0 | 6                           | 10   | 6     | 0 | 27                      | 51   | 7     | 0 | 11                      | 19   | 6     | 0 | 156   | 2075          |
| 5:45 PM                         | 2                           | 7    | 5     | 0 | 2                           | 10   | 7     | 0 | 20                      | 42   | 10    | 0 | 13                      | 24   | 0     | 0 | 142   | 2025          |
| 5:50 PM                         | 1                           | 12   | 12    | 0 | 4                           | 13   | 5     | 0 | 14                      | 39   | 8     | 0 | 13                      | 21   | 1     | 0 | 143   | 1984          |
| 5:55 PM                         | 4                           | 14   | 9     | 0 | 2                           | 9    | 2     | 0 | 12                      | 41   | 5     | 0 | 18                      | 22   | 0     | 0 | 138   | 1954          |
| Peak 15-Min Flowrates           | Northbound                  |      |       |   | Southbound                  |      |       |   | Eastbound               |      |       |   | Westbound               |      |       |   | Total |               |
|                                 | Left                        | Thru | Right | U | Left                        | Thru | Right | U | Left                    | Thru | Right | U | Left                    | Thru | Right | U |       |               |
| All Vehicles                    | 8                           | 112  | 60    | 0 | 80                          | 112  | 108   | 0 | 524                     | 596  | 84    | 0 | 168                     | 356  | 56    | 0 | 2264  |               |
| Heavy Trucks                    | 0                           | 0    | 4     |   | 24                          | 0    | 4     |   | 44                      | 56   | 0     |   | 0                       | 32   | 16    |   | 180   |               |
| Pedestrians                     |                             | 8    |       |   |                             | 0    |       |   |                         | 0    |       |   |                         | 0    |       |   | 8     |               |
| Bicycles                        | 0                           | 0    | 0     |   | 0                           | 0    | 0     |   | 0                       | 0    | 0     |   | 0                       | 0    | 0     |   | 0     |               |
| Railroad                        |                             |      |       |   |                             |      |       |   |                         |      |       |   |                         |      |       |   |       |               |
| Stopped Buses                   |                             |      |       |   |                             |      |       |   |                         |      |       |   |                         |      |       |   |       |               |

Comments:

**LOCATION:** 13. Airport Way -- Charter Way  
**CITY/STATE:** Stockton, CA

**QC JOB #:** 14437925  
**DATE:** Thu, Jun 01 2017

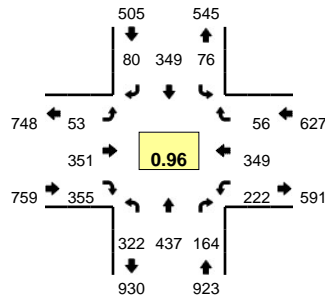

**Peak-Hour: 7:15 AM -- 8:15 AM**  
**Peak 15-Min: 7:40 AM -- 7:55 AM**

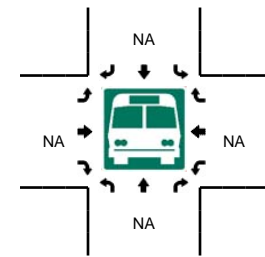
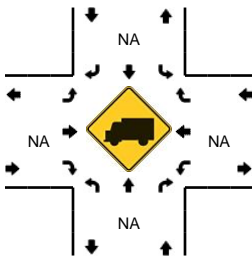
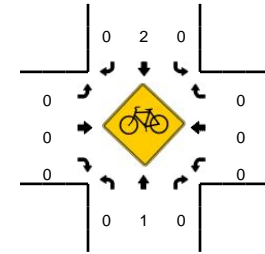
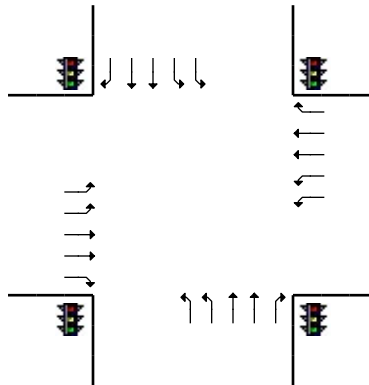
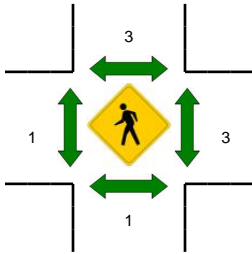
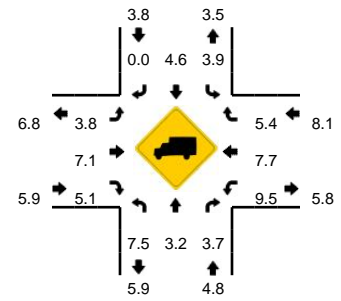

| 5-Min Count Period Beginning At | 13. Airport Way (Northbound) |      |       |   | 13. Airport Way (Southbound) |      |       |   | Charter Way (Eastbound) |      |       |   | Charter Way (Westbound) |      |       |   | Total | Hourly Totals |
|---------------------------------|------------------------------|------|-------|---|------------------------------|------|-------|---|-------------------------|------|-------|---|-------------------------|------|-------|---|-------|---------------|
|                                 | Left                         | Thru | Right | U | Left                         | Thru | Right | U | Left                    | Thru | Right | U | Left                    | Thru | Right | U |       |               |
| 7:00 AM                         | 10                           | 14   | 19    | 2 | 2                            | 26   | 7     | 1 | 3                       | 25   | 20    | 0 | 9                       | 31   | 2     | 0 | 171   |               |
| 7:05 AM                         | 25                           | 16   | 11    | 0 | 6                            | 20   | 8     | 0 | 4                       | 26   | 22    | 0 | 16                      | 31   | 2     | 0 | 187   |               |
| 7:10 AM                         | 30                           | 20   | 13    | 0 | 4                            | 24   | 6     | 0 | 0                       | 29   | 22    | 0 | 17                      | 30   | 2     | 0 | 197   |               |
| 7:15 AM                         | 24                           | 35   | 11    | 3 | 4                            | 31   | 8     | 0 | 3                       | 23   | 35    | 0 | 23                      | 30   | 6     | 0 | 236   |               |
| 7:20 AM                         | 34                           | 39   | 12    | 1 | 3                            | 35   | 11    | 0 | 4                       | 30   | 28    | 0 | 24                      | 23   | 3     | 0 | 247   |               |
| 7:25 AM                         | 21                           | 32   | 18    | 0 | 5                            | 19   | 4     | 0 | 6                       | 26   | 31    | 0 | 22                      | 26   | 3     | 0 | 213   |               |
| 7:30 AM                         | 24                           | 36   | 12    | 0 | 4                            | 23   | 7     | 0 | 3                       | 26   | 33    | 1 | 18                      | 26   | 5     | 0 | 218   |               |
| 7:35 AM                         | 29                           | 41   | 14    | 0 | 1                            | 20   | 7     | 0 | 5                       | 31   | 29    | 0 | 18                      | 28   | 3     | 0 | 226   |               |
| 7:40 AM                         | 26                           | 50   | 18    | 0 | 11                           | 26   | 7     | 0 | 4                       | 40   | 23    | 0 | 17                      | 19   | 3     | 0 | 244   |               |
| 7:45 AM                         | 28                           | 27   | 19    | 0 | 9                            | 34   | 9     | 0 | 6                       | 32   | 25    | 0 | 19                      | 25   | 11    | 0 | 244   |               |
| 7:50 AM                         | 33                           | 47   | 11    | 0 | 8                            | 30   | 2     | 0 | 3                       | 19   | 34    | 0 | 15                      | 34   | 6     | 0 | 242   |               |
| 7:55 AM                         | 32                           | 40   | 12    | 0 | 7                            | 31   | 4     | 0 | 5                       | 22   | 29    | 0 | 18                      | 22   | 2     | 0 | 224   | 2649          |
| 8:00 AM                         | 26                           | 33   | 11    | 0 | 11                           | 39   | 8     | 0 | 3                       | 34   | 29    | 0 | 9                       | 33   | 4     | 0 | 240   | 2718          |
| 8:05 AM                         | 20                           | 32   | 13    | 0 | 6                            | 34   | 6     | 0 | 7                       | 37   | 31    | 0 | 17                      | 41   | 7     | 0 | 251   | 2782          |
| 8:10 AM                         | 21                           | 25   | 13    | 0 | 7                            | 27   | 7     | 0 | 3                       | 31   | 28    | 0 | 22                      | 42   | 3     | 0 | 229   | 2814          |
| 8:15 AM                         | 30                           | 30   | 18    | 2 | 3                            | 28   | 6     | 0 | 3                       | 27   | 27    | 0 | 25                      | 21   | 8     | 0 | 228   | 2806          |
| 8:20 AM                         | 35                           | 31   | 7     | 0 | 7                            | 20   | 6     | 0 | 5                       | 22   | 29    | 0 | 14                      | 29   | 7     | 0 | 212   | 2771          |
| 8:25 AM                         | 27                           | 28   | 11    | 0 | 2                            | 25   | 13    | 0 | 7                       | 12   | 30    | 0 | 18                      | 28   | 3     | 0 | 204   | 2762          |
| 8:30 AM                         | 23                           | 27   | 10    | 0 | 8                            | 21   | 5     | 0 | 6                       | 21   | 27    | 0 | 14                      | 17   | 5     | 0 | 184   | 2728          |
| 8:35 AM                         | 32                           | 29   | 19    | 0 | 4                            | 22   | 5     | 0 | 5                       | 27   | 26    | 0 | 21                      | 30   | 5     | 0 | 225   | 2727          |
| 8:40 AM                         | 23                           | 32   | 16    | 1 | 7                            | 27   | 9     | 0 | 4                       | 35   | 20    | 0 | 13                      | 26   | 5     | 0 | 218   | 2701          |
| 8:45 AM                         | 19                           | 29   | 13    | 0 | 5                            | 16   | 7     | 0 | 2                       | 41   | 19    | 0 | 27                      | 24   | 4     | 0 | 206   | 2663          |
| 8:50 AM                         | 22                           | 24   | 15    | 2 | 0                            | 1    | 6     | 0 | 7                       | 29   | 29    | 0 | 27                      | 40   | 2     | 0 | 204   | 2625          |
| 8:55 AM                         | 18                           | 17   | 22    | 0 | 1                            | 3    | 6     | 0 | 5                       | 27   | 38    | 0 | 33                      | 42   | 4     | 0 | 216   | 2617          |
| Peak 15-Min Flowrates           | Northbound                   |      |       |   | Southbound                   |      |       |   | Eastbound               |      |       |   | Westbound               |      |       |   | Total |               |
|                                 | Left                         | Thru | Right | U | Left                         | Thru | Right | U | Left                    | Thru | Right | U | Left                    | Thru | Right | U |       |               |
| All Vehicles                    | 348                          | 496  | 192   | 0 | 112                          | 360  | 72    | 0 | 52                      | 364  | 328   | 0 | 204                     | 312  | 80    | 0 | 2920  |               |
| Heavy Trucks                    | 36                           | 8    | 8     |   | 4                            | 4    | 0     |   | 0                       | 32   | 20    |   | 20                      | 24   | 0     |   | 156   |               |
| Pedestrians                     | 4                            |      |       |   | 4                            |      |       |   | 4                       |      |       |   | 8                       |      |       |   | 20    |               |
| Bicycles                        | 0                            | 0    | 0     |   | 0                            | 2    | 0     |   | 0                       | 0    | 0     |   | 0                       | 0    | 0     |   | 2     |               |
| Railroad                        |                              |      |       |   |                              |      |       |   |                         |      |       |   |                         |      |       |   |       |               |
| Stopped Buses                   |                              |      |       |   |                              |      |       |   |                         |      |       |   |                         |      |       |   |       |               |

Comments:

**LOCATION:** 13. Airport Way -- Charter Way  
**CITY/STATE:** Stockton, CA

**QC JOB #:** 14437926  
**DATE:** Thu, Jun 01 2017

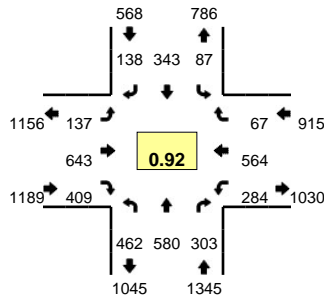

**Peak-Hour: 4:00 PM -- 5:00 PM**  
**Peak 15-Min: 4:05 PM -- 4:20 PM**

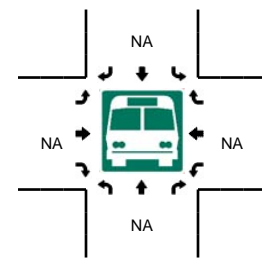
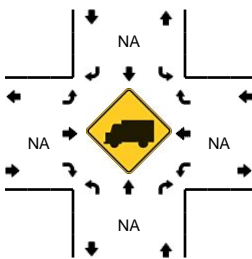
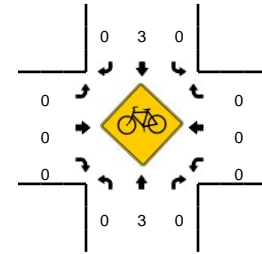
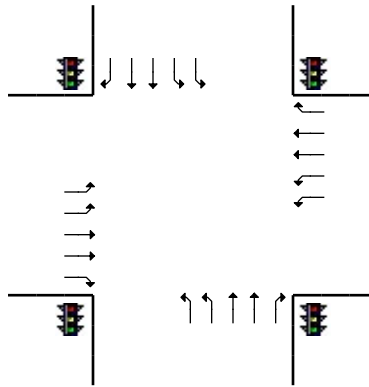
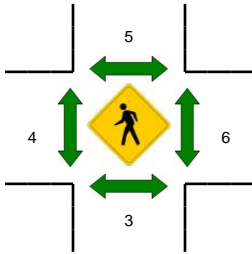
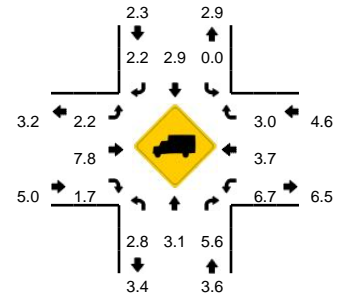

| 5-Min Count Period Beginning At | 13. Airport Way (Northbound) |      |       |   | 13. Airport Way (Southbound) |      |       |   | Charter Way (Eastbound) |      |       |   | Charter Way (Westbound) |      |       |   | Total | Hourly Totals |
|---------------------------------|------------------------------|------|-------|---|------------------------------|------|-------|---|-------------------------|------|-------|---|-------------------------|------|-------|---|-------|---------------|
|                                 | Left                         | Thru | Right | U | Left                         | Thru | Right | U | Left                    | Thru | Right | U | Left                    | Thru | Right | U |       |               |
| 4:00 PM                         | 48                           | 31   | 20    | 1 | 11                           | 25   | 6     | 1 | 20                      | 63   | 38    | 0 | 11                      | 37   | 7     | 0 | 319   |               |
| 4:05 PM                         | 28                           | 73   | 23    | 0 | 8                            | 39   | 18    | 0 | 15                      | 54   | 33    | 0 | 19                      | 55   | 9     | 0 | 374   |               |
| 4:10 PM                         | 46                           | 59   | 32    | 0 | 6                            | 23   | 14    | 1 | 11                      | 60   | 30    | 0 | 26                      | 55   | 7     | 0 | 370   |               |
| 4:15 PM                         | 60                           | 51   | 36    | 1 | 9                            | 30   | 10    | 1 | 11                      | 57   | 32    | 0 | 15                      | 34   | 6     | 0 | 353   |               |
| 4:20 PM                         | 26                           | 38   | 19    | 1 | 8                            | 43   | 11    | 0 | 6                       | 51   | 27    | 1 | 27                      | 48   | 6     | 0 | 312   |               |
| 4:25 PM                         | 30                           | 40   | 21    | 0 | 7                            | 26   | 10    | 0 | 17                      | 51   | 33    | 0 | 20                      | 56   | 4     | 0 | 315   |               |
| 4:30 PM                         | 16                           | 50   | 24    | 1 | 6                            | 32   | 14    | 0 | 9                       | 45   | 42    | 0 | 26                      | 45   | 3     | 0 | 313   |               |
| 4:35 PM                         | 38                           | 49   | 35    | 0 | 13                           | 34   | 7     | 0 | 7                       | 33   | 38    | 0 | 19                      | 38   | 10    | 0 | 321   |               |
| 4:40 PM                         | 40                           | 41   | 16    | 0 | 5                            | 27   | 12    | 0 | 16                      | 58   | 35    | 0 | 41                      | 70   | 3     | 0 | 364   |               |
| 4:45 PM                         | 58                           | 70   | 30    | 3 | 7                            | 28   | 15    | 0 | 9                       | 50   | 38    | 0 | 28                      | 38   | 9     | 0 | 383   |               |
| 4:50 PM                         | 33                           | 42   | 23    | 0 | 4                            | 28   | 10    | 0 | 11                      | 62   | 36    | 0 | 24                      | 44   | 0     | 0 | 317   |               |
| 4:55 PM                         | 30                           | 36   | 24    | 2 | 0                            | 8    | 11    | 0 | 4                       | 59   | 27    | 0 | 28                      | 44   | 3     | 0 | 276   | 4017          |
| 5:00 PM                         | 36                           | 39   | 22    | 0 | 7                            | 40   | 16    | 0 | 4                       | 31   | 39    | 0 | 19                      | 39   | 6     | 0 | 298   | 3996          |
| 5:05 PM                         | 31                           | 43   | 21    | 1 | 8                            | 38   | 14    | 0 | 14                      | 52   | 23    | 0 | 25                      | 71   | 6     | 0 | 347   | 3969          |
| 5:10 PM                         | 46                           | 44   | 30    | 0 | 5                            | 32   | 17    | 0 | 8                       | 59   | 39    | 0 | 13                      | 55   | 6     | 0 | 354   | 3953          |
| 5:15 PM                         | 42                           | 46   | 22    | 0 | 3                            | 39   | 20    | 0 | 12                      | 40   | 32    | 0 | 35                      | 50   | 2     | 0 | 343   | 3943          |
| 5:20 PM                         | 37                           | 40   | 23    | 0 | 6                            | 48   | 14    | 0 | 11                      | 56   | 48    | 0 | 18                      | 42   | 5     | 0 | 348   | 3979          |
| 5:25 PM                         | 22                           | 18   | 26    | 0 | 2                            | 42   | 14    | 0 | 10                      | 58   | 31    | 0 | 29                      | 42   | 8     | 0 | 302   | 3966          |
| 5:30 PM                         | 47                           | 27   | 16    | 0 | 9                            | 30   | 7     | 0 | 4                       | 54   | 35    | 0 | 11                      | 46   | 4     | 0 | 290   | 3943          |
| 5:35 PM                         | 19                           | 39   | 18    | 0 | 6                            | 45   | 16    | 0 | 9                       | 43   | 38    | 0 | 34                      | 35   | 9     | 0 | 311   | 3933          |
| 5:40 PM                         | 30                           | 31   | 21    | 1 | 5                            | 21   | 8     | 0 | 12                      | 48   | 35    | 0 | 18                      | 36   | 5     | 0 | 271   | 3840          |
| 5:45 PM                         | 45                           | 37   | 24    | 0 | 11                           | 24   | 14    | 0 | 9                       | 58   | 46    | 0 | 13                      | 39   | 6     | 0 | 326   | 3783          |
| 5:50 PM                         | 28                           | 35   | 16    | 0 | 2                            | 26   | 4     | 0 | 10                      | 56   | 38    | 0 | 12                      | 55   | 3     | 0 | 285   | 3751          |
| 5:55 PM                         | 21                           | 21   | 11    | 0 | 11                           | 32   | 15    | 0 | 5                       | 48   | 43    | 0 | 21                      | 44   | 4     | 0 | 276   | 3751          |
| Peak 15-Min Flowrates           | Northbound                   |      |       |   | Southbound                   |      |       |   | Eastbound               |      |       |   | Westbound               |      |       |   | Total |               |
|                                 | Left                         | Thru | Right | U | Left                         | Thru | Right | U | Left                    | Thru | Right | U | Left                    | Thru | Right | U |       |               |
| All Vehicles                    | 536                          | 732  | 364   | 4 | 92                           | 368  | 168   | 8 | 148                     | 684  | 380   | 0 | 240                     | 576  | 88    | 0 | 4388  |               |
| Heavy Trucks                    | 12                           | 16   | 28    |   | 0                            | 4    | 12    |   | 4                       | 76   | 8     |   | 16                      | 24   | 8     |   | 208   |               |
| Pedestrians                     |                              | 4    |       |   |                              | 4    |       |   |                         | 0    |       |   |                         | 4    |       |   | 12    |               |
| Bicycles                        |                              | 2    | 0     |   |                              | 2    | 0     |   |                         | 0    | 0     |   |                         | 0    | 0     |   | 4     |               |
| Railroad                        |                              |      |       |   |                              |      |       |   |                         |      |       |   |                         |      |       |   |       |               |
| Stopped Buses                   |                              |      |       |   |                              |      |       |   |                         |      |       |   |                         |      |       |   |       |               |

Comments:

**LOCATION:** 14. Mariposa Rd -- Charter Way  
**CITY/STATE:** San Joaquin, CA

**QC JOB #:** 14437927  
**DATE:** Thu, Jun 01 2017

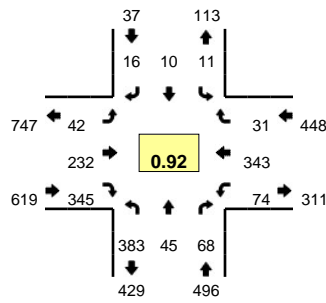

**Peak-Hour: 7:20 AM -- 8:20 AM**  
**Peak 15-Min: 7:40 AM -- 7:55 AM**

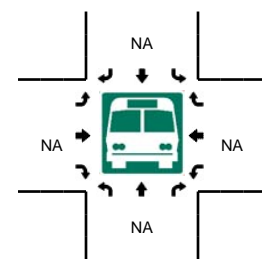
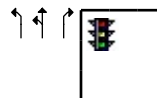
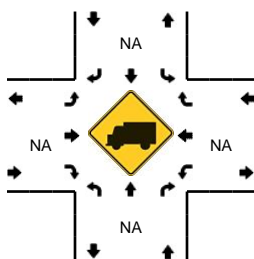
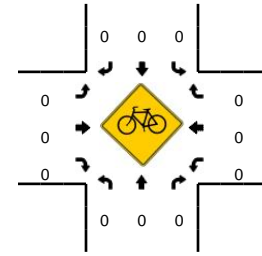
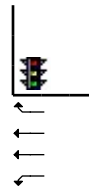
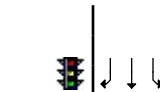
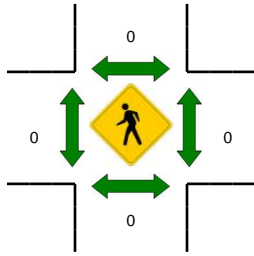
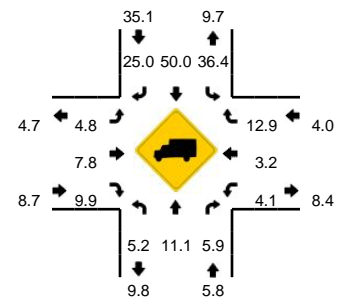

| 5-Min Count Period Beginning At | 14. Mariposa Rd (Northbound) |      |       |   | 14. Mariposa Rd (Southbound) |      |       |   | Charter Way (Eastbound) |      |       |   | Charter Way (Westbound) |      |       |   | Total | Hourly Totals |
|---------------------------------|------------------------------|------|-------|---|------------------------------|------|-------|---|-------------------------|------|-------|---|-------------------------|------|-------|---|-------|---------------|
|                                 | Left                         | Thru | Right | U | Left                         | Thru | Right | U | Left                    | Thru | Right | U | Left                    | Thru | Right | U |       |               |
| 7:00 AM                         | 25                           | 2    | 4     | 0 | 1                            | 1    | 1     | 0 | 2                       | 18   | 20    | 1 | 4                       | 23   | 3     | 0 | 105   |               |
| 7:05 AM                         | 18                           | 0    | 10    | 0 | 0                            | 0    | 4     | 0 | 0                       | 18   | 18    | 2 | 5                       | 27   | 0     | 0 | 102   |               |
| 7:10 AM                         | 26                           | 0    | 7     | 0 | 3                            | 0    | 4     | 0 | 2                       | 28   | 19    | 1 | 13                      | 24   | 1     | 0 | 128   |               |
| 7:15 AM                         | 39                           | 3    | 5     | 0 | 0                            | 2    | 1     | 0 | 1                       | 16   | 19    | 1 | 3                       | 26   | 1     | 0 | 117   |               |
| 7:20 AM                         | 29                           | 2    | 7     | 0 | 0                            | 1    | 1     | 0 | 2                       | 15   | 13    | 2 | 7                       | 20   | 2     | 0 | 101   |               |
| 7:25 AM                         | 19                           | 2    | 3     | 0 | 1                            | 0    | 0     | 0 | 2                       | 28   | 18    | 1 | 10                      | 35   | 2     | 0 | 121   |               |
| 7:30 AM                         | 41                           | 5    | 3     | 0 | 1                            | 2    | 0     | 0 | 2                       | 20   | 30    | 1 | 7                       | 30   | 3     | 0 | 145   |               |
| 7:35 AM                         | 31                           | 3    | 6     | 0 | 0                            | 1    | 1     | 0 | 4                       | 21   | 16    | 1 | 6                       | 26   | 4     | 0 | 120   |               |
| 7:40 AM                         | 28                           | 3    | 6     | 0 | 1                            | 3    | 0     | 0 | 2                       | 18   | 37    | 0 | 7                       | 26   | 1     | 0 | 132   |               |
| 7:45 AM                         | 42                           | 5    | 3     | 0 | 0                            | 0    | 1     | 0 | 5                       | 29   | 15    | 0 | 5                       | 31   | 5     | 0 | 141   |               |
| 7:50 AM                         | 45                           | 6    | 5     | 0 | 1                            | 0    | 1     | 0 | 3                       | 9    | 49    | 0 | 8                       | 30   | 5     | 0 | 162   |               |
| 7:55 AM                         | 29                           | 9    | 11    | 0 | 1                            | 1    | 1     | 0 | 3                       | 19   | 17    | 0 | 9                       | 27   | 2     | 0 | 129   | 1503          |
| 8:00 AM                         | 31                           | 4    | 5     | 0 | 0                            | 1    | 3     | 0 | 7                       | 25   | 29    | 0 | 6                       | 26   | 4     | 0 | 141   | 1539          |
| 8:05 AM                         | 36                           | 3    | 9     | 0 | 5                            | 1    | 2     | 0 | 1                       | 18   | 40    | 0 | 2                       | 39   | 0     | 0 | 156   | 1593          |
| 8:10 AM                         | 18                           | 2    | 9     | 0 | 0                            | 0    | 2     | 0 | 4                       | 22   | 39    | 0 | 2                       | 25   | 1     | 0 | 124   | 1589          |
| 8:15 AM                         | 34                           | 1    | 1     | 0 | 1                            | 0    | 4     | 0 | 2                       | 8    | 42    | 0 | 5                       | 28   | 2     | 0 | 128   | 1600          |
| 8:20 AM                         | 23                           | 1    | 3     | 0 | 1                            | 0    | 1     | 0 | 2                       | 12   | 27    | 0 | 2                       | 18   | 2     | 0 | 92    | 1591          |
| 8:25 AM                         | 34                           | 3    | 9     | 0 | 0                            | 1    | 0     | 0 | 2                       | 12   | 22    | 1 | 5                       | 18   | 1     | 0 | 108   | 1578          |
| 8:30 AM                         | 25                           | 0    | 3     | 0 | 1                            | 2    | 3     | 0 | 3                       | 12   | 18    | 2 | 6                       | 21   | 2     | 0 | 98    | 1531          |
| 8:35 AM                         | 24                           | 3    | 1     | 0 | 3                            | 0    | 0     | 0 | 4                       | 12   | 41    | 0 | 8                       | 18   | 1     | 0 | 115   | 1526          |
| 8:40 AM                         | 36                           | 0    | 4     | 0 | 0                            | 1    | 1     | 0 | 1                       | 13   | 34    | 0 | 5                       | 15   | 0     | 0 | 110   | 1504          |
| 8:45 AM                         | 41                           | 2    | 9     | 0 | 1                            | 0    | 3     | 0 | 3                       | 17   | 35    | 0 | 5                       | 31   | 1     | 0 | 148   | 1511          |
| 8:50 AM                         | 32                           | 1    | 10    | 0 | 0                            | 0    | 0     | 0 | 0                       | 10   | 30    | 1 | 11                      | 25   | 0     | 0 | 120   | 1469          |
| 8:55 AM                         | 33                           | 0    | 4     | 0 | 2                            | 2    | 1     | 0 | 0                       | 19   | 23    | 2 | 8                       | 27   | 1     | 0 | 122   | 1462          |
| Peak 15-Min Flowrates           | Northbound                   |      |       |   | Southbound                   |      |       |   | Eastbound               |      |       |   | Westbound               |      |       |   | Total |               |
|                                 | Left                         | Thru | Right | U | Left                         | Thru | Right | U | Left                    | Thru | Right | U | Left                    | Thru | Right | U |       |               |
| All Vehicles                    | 460                          | 56   | 56    | 0 | 8                            | 12   | 8     | 0 | 40                      | 224  | 404   | 0 | 80                      | 348  | 44    | 0 | 1740  |               |
| Heavy Trucks                    | 16                           | 0    | 12    |   | 0                            | 4    | 0     |   | 4                       | 24   | 36    |   | 4                       | 16   | 0     |   | 116   |               |
| Pedestrians                     |                              | 0    |       |   |                              | 0    |       |   |                         | 0    |       |   |                         | 0    |       |   | 0     |               |
| Bicycles                        |                              | 0    | 0     |   |                              | 0    | 0     |   |                         | 0    | 0     |   |                         | 0    | 0     |   | 0     |               |
| Railroad                        |                              |      |       |   |                              |      |       |   |                         |      |       |   |                         |      |       |   |       |               |
| Stopped Buses                   |                              |      |       |   |                              |      |       |   |                         |      |       |   |                         |      |       |   |       |               |

Comments:

**LOCATION:** 14. Mariposa Rd -- Charter Way  
**CITY/STATE:** San Joaquin, CA

**QC JOB #:** 14437928  
**DATE:** Thu, Jun 01 2017

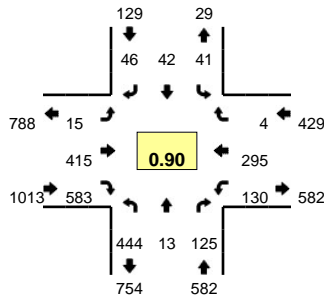

**Peak-Hour: 4:15 PM -- 5:15 PM**  
**Peak 15-Min: 5:00 PM -- 5:15 PM**

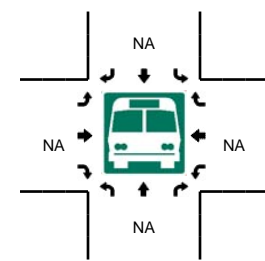
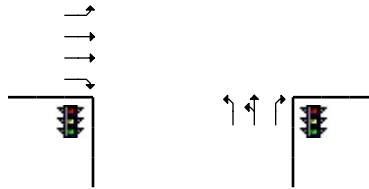
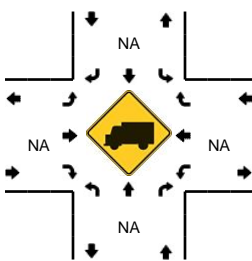
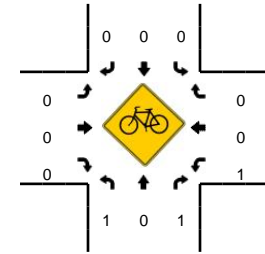
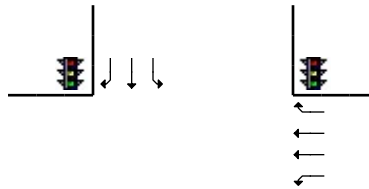
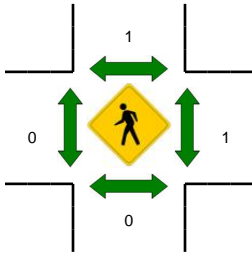
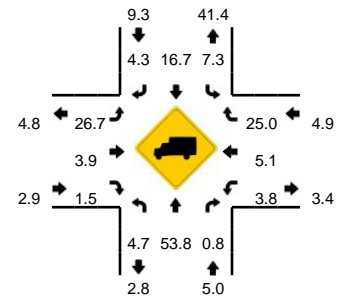

| 5-Min Count Period Beginning At | 14. Mariposa Rd (Northbound) |      |       |   | 14. Mariposa Rd (Southbound) |      |       |   | Charter Way (Eastbound) |      |       |   | Charter Way (Westbound) |      |       |   | Total | Hourly Totals |
|---------------------------------|------------------------------|------|-------|---|------------------------------|------|-------|---|-------------------------|------|-------|---|-------------------------|------|-------|---|-------|---------------|
|                                 | Left                         | Thru | Right | U | Left                         | Thru | Right | U | Left                    | Thru | Right | U | Left                    | Thru | Right | U |       |               |
| 4:00 PM                         | 38                           | 0    | 15    | 0 | 2                            | 2    | 3     | 0 | 1                       | 48   | 35    | 0 | 9                       | 24   | 2     | 0 | 179   |               |
| 4:05 PM                         | 35                           | 0    | 14    | 0 | 3                            | 4    | 0     | 0 | 6                       | 35   | 57    | 0 | 3                       | 24   | 0     | 0 | 181   |               |
| 4:10 PM                         | 44                           | 3    | 7     | 0 | 1                            | 2    | 1     | 0 | 2                       | 47   | 46    | 1 | 9                       | 19   | 0     | 0 | 182   |               |
| 4:15 PM                         | 32                           | 3    | 18    | 0 | 2                            | 0    | 3     | 0 | 2                       | 36   | 27    | 0 | 20                      | 28   | 0     | 0 | 171   |               |
| 4:20 PM                         | 35                           | 1    | 10    | 0 | 2                            | 4    | 6     | 0 | 2                       | 22   | 56    | 0 | 12                      | 22   | 0     | 0 | 172   |               |
| 4:25 PM                         | 38                           | 1    | 3     | 0 | 2                            | 0    | 2     | 0 | 0                       | 24   | 51    | 0 | 10                      | 24   | 0     | 0 | 155   |               |
| 4:30 PM                         | 29                           | 3    | 5     | 0 | 3                            | 2    | 4     | 0 | 0                       | 38   | 47    | 0 | 10                      | 24   | 0     | 0 | 165   |               |
| 4:35 PM                         | 42                           | 0    | 10    | 0 | 7                            | 9    | 10    | 0 | 0                       | 39   | 56    | 0 | 11                      | 25   | 0     | 0 | 209   |               |
| 4:40 PM                         | 42                           | 1    | 7     | 0 | 7                            | 2    | 1     | 0 | 0                       | 33   | 52    | 0 | 9                       | 19   | 0     | 0 | 173   |               |
| 4:45 PM                         | 36                           | 1    | 11    | 0 | 2                            | 1    | 2     | 0 | 0                       | 43   | 49    | 0 | 13                      | 21   | 2     | 0 | 181   |               |
| 4:50 PM                         | 32                           | 0    | 10    | 0 | 0                            | 3    | 3     | 0 | 3                       | 32   | 52    | 3 | 9                       | 19   | 2     | 1 | 169   |               |
| 4:55 PM                         | 28                           | 2    | 6     | 0 | 5                            | 3    | 2     | 0 | 1                       | 32   | 45    | 0 | 6                       | 28   | 0     | 0 | 158   | 2095          |
| 5:00 PM                         | 39                           | 0    | 20    | 0 | 5                            | 1    | 4     | 0 | 1                       | 29   | 48    | 0 | 11                      | 23   | 0     | 0 | 181   | 2097          |
| 5:05 PM                         | 50                           | 0    | 16    | 0 | 1                            | 7    | 4     | 0 | 2                       | 50   | 62    | 0 | 8                       | 23   | 0     | 0 | 223   | 2139          |
| 5:10 PM                         | 41                           | 1    | 9     | 0 | 5                            | 10   | 5     | 0 | 1                       | 37   | 38    | 0 | 10                      | 39   | 0     | 0 | 196   | 2153          |
| 5:15 PM                         | 24                           | 0    | 5     | 0 | 3                            | 3    | 2     | 0 | 3                       | 31   | 55    | 0 | 8                       | 23   | 0     | 0 | 157   | 2139          |
| 5:20 PM                         | 25                           | 1    | 12    | 0 | 2                            | 1    | 4     | 0 | 0                       | 34   | 52    | 1 | 7                       | 27   | 0     | 0 | 166   | 2133          |
| 5:25 PM                         | 34                           | 0    | 7     | 0 | 1                            | 0    | 2     | 0 | 1                       | 40   | 51    | 0 | 10                      | 23   | 0     | 0 | 169   | 2147          |
| 5:30 PM                         | 23                           | 0    | 7     | 0 | 2                            | 0    | 1     | 0 | 3                       | 29   | 36    | 0 | 7                       | 21   | 0     | 1 | 130   | 2112          |
| 5:35 PM                         | 29                           | 0    | 8     | 0 | 0                            | 2    | 2     | 0 | 0                       | 34   | 47    | 0 | 10                      | 16   | 0     | 0 | 148   | 2051          |
| 5:40 PM                         | 28                           | 1    | 11    | 0 | 1                            | 1    | 0     | 0 | 0                       | 40   | 34    | 0 | 10                      | 15   | 0     | 0 | 141   | 2019          |
| 5:45 PM                         | 36                           | 1    | 7     | 0 | 0                            | 0    | 1     | 0 | 2                       | 34   | 51    | 0 | 6                       | 20   | 3     | 0 | 161   | 1999          |
| 5:50 PM                         | 28                           | 1    | 6     | 0 | 0                            | 1    | 2     | 0 | 1                       | 20   | 32    | 1 | 7                       | 19   | 0     | 1 | 119   | 1949          |
| 5:55 PM                         | 25                           | 1    | 8     | 0 | 4                            | 3    | 1     | 0 | 0                       | 25   | 41    | 1 | 6                       | 27   | 0     | 1 | 143   | 1934          |
| Peak 15-Min Flowrates           | Northbound                   |      |       |   | Southbound                   |      |       |   | Eastbound               |      |       |   | Westbound               |      |       |   | Total |               |
|                                 | Left                         | Thru | Right | U | Left                         | Thru | Right | U | Left                    | Thru | Right | U | Left                    | Thru | Right | U |       |               |
| All Vehicles                    | 520                          | 4    | 180   | 0 | 44                           | 72   | 52    | 0 | 16                      | 464  | 592   | 0 | 116                     | 340  | 0     | 0 | 2400  |               |
| Heavy Trucks                    | 16                           | 4    | 4     |   | 4                            | 8    | 0     |   | 12                      | 12   | 4     |   | 4                       | 44   | 0     |   | 112   |               |
| Pedestrians                     |                              | 0    |       |   |                              | 4    |       |   |                         | 0    |       |   |                         | 4    |       |   | 8     |               |
| Bicycles                        | 1                            | 0    | 0     |   | 0                            | 0    | 0     |   | 0                       | 0    | 0     |   | 1                       | 0    | 0     |   | 2     |               |
| Railroad                        |                              |      |       |   |                              |      |       |   |                         |      |       |   |                         |      |       |   |       |               |
| Stopped Buses                   |                              |      |       |   |                              |      |       |   |                         |      |       |   |                         |      |       |   |       |               |

Comments:

**LOCATION:** 15. Mariposa Rd -- Stagecoach Rd  
**CITY/STATE:** San Joaquin, CA

**QC JOB #:** 14437929  
**DATE:** Thu, Jun 01 2017

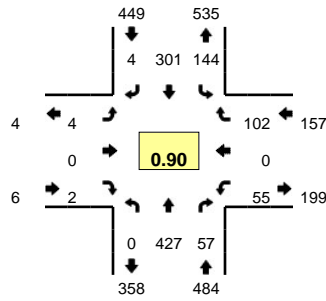

**Peak-Hour: 7:15 AM -- 8:15 AM**  
**Peak 15-Min: 7:35 AM -- 7:50 AM**

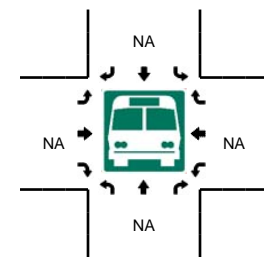
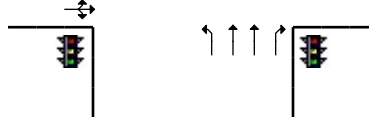
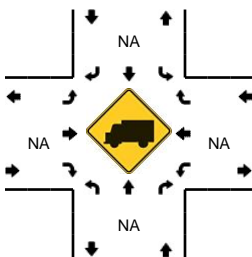
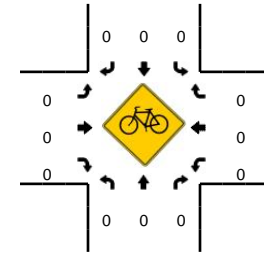
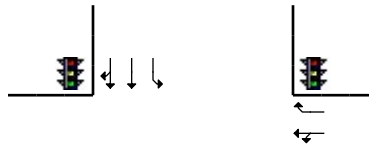
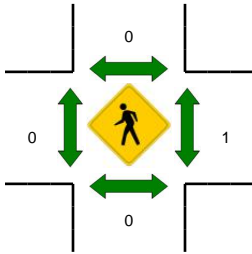
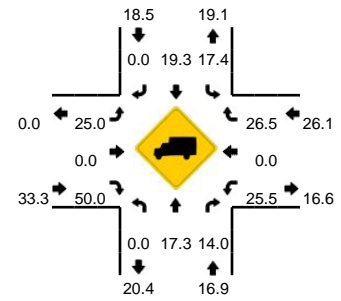

| 5-Min Count Period Beginning At | 15. Mariposa Rd (Northbound) |      |       |   | 15. Mariposa Rd (Southbound) |      |       |   | Stagecoach Rd (Eastbound) |      |       |   | Stagecoach Rd (Westbound) |      |       |   | Total | Hourly Totals |
|---------------------------------|------------------------------|------|-------|---|------------------------------|------|-------|---|---------------------------|------|-------|---|---------------------------|------|-------|---|-------|---------------|
|                                 | Left                         | Thru | Right | U | Left                         | Thru | Right | U | Left                      | Thru | Right | U | Left                      | Thru | Right | U |       |               |
| 7:00 AM                         | 0                            | 25   | 7     | 0 | 16                           | 15   | 1     | 0 | 0                         | 1    | 0     | 0 | 3                         | 0    | 4     | 1 | 73    |               |
| 7:05 AM                         | 0                            | 28   | 3     | 0 | 11                           | 12   | 1     | 0 | 0                         | 1    | 0     | 0 | 2                         | 0    | 6     | 0 | 64    |               |
| 7:10 AM                         | 0                            | 27   | 7     | 0 | 9                            | 17   | 2     | 0 | 0                         | 0    | 0     | 0 | 8                         | 0    | 9     | 0 | 79    |               |
| 7:15 AM                         | 0                            | 34   | 2     | 0 | 15                           | 18   | 0     | 0 | 0                         | 0    | 0     | 0 | 4                         | 0    | 5     | 0 | 78    |               |
| 7:20 AM                         | 0                            | 41   | 5     | 0 | 12                           | 20   | 0     | 1 | 0                         | 0    | 0     | 0 | 6                         | 0    | 11    | 0 | 96    |               |
| 7:25 AM                         | 0                            | 33   | 6     | 0 | 9                            | 41   | 0     | 0 | 1                         | 0    | 1     | 0 | 1                         | 0    | 5     | 0 | 97    |               |
| 7:30 AM                         | 0                            | 19   | 3     | 0 | 23                           | 24   | 1     | 0 | 0                         | 0    | 0     | 0 | 4                         | 0    | 9     | 0 | 83    |               |
| 7:35 AM                         | 0                            | 41   | 5     | 0 | 4                            | 33   | 0     | 0 | 0                         | 0    | 0     | 0 | 4                         | 0    | 9     | 0 | 96    |               |
| 7:40 AM                         | 0                            | 48   | 9     | 0 | 9                            | 24   | 0     | 0 | 0                         | 0    | 0     | 0 | 8                         | 0    | 13    | 0 | 111   |               |
| 7:45 AM                         | 0                            | 38   | 2     | 0 | 16                           | 29   | 0     | 0 | 0                         | 0    | 0     | 0 | 5                         | 0    | 8     | 0 | 98    |               |
| 7:50 AM                         | 0                            | 31   | 6     | 0 | 12                           | 21   | 0     | 0 | 0                         | 0    | 0     | 0 | 10                        | 0    | 10    | 0 | 90    |               |
| 7:55 AM                         | 0                            | 49   | 3     | 0 | 15                           | 26   | 2     | 0 | 1                         | 0    | 0     | 0 | 3                         | 0    | 12    | 0 | 111   | 1076          |
| 8:00 AM                         | 0                            | 37   | 6     | 0 | 9                            | 24   | 0     | 0 | 1                         | 0    | 0     | 0 | 4                         | 0    | 6     | 0 | 87    | 1090          |
| 8:05 AM                         | 0                            | 21   | 2     | 0 | 9                            | 13   | 0     | 1 | 1                         | 0    | 0     | 0 | 1                         | 0    | 7     | 0 | 55    | 1081          |
| 8:10 AM                         | 0                            | 35   | 8     | 0 | 9                            | 28   | 1     | 0 | 0                         | 0    | 1     | 0 | 5                         | 0    | 7     | 0 | 94    | 1096          |
| 8:15 AM                         | 0                            | 39   | 0     | 0 | 7                            | 22   | 0     | 0 | 0                         | 0    | 0     | 0 | 3                         | 0    | 6     | 0 | 77    | 1095          |
| 8:20 AM                         | 0                            | 24   | 5     | 0 | 6                            | 22   | 1     | 0 | 0                         | 0    | 0     | 0 | 4                         | 0    | 6     | 0 | 68    | 1067          |
| 8:25 AM                         | 0                            | 38   | 2     | 0 | 10                           | 17   | 1     | 0 | 1                         | 1    | 0     | 0 | 7                         | 0    | 6     | 0 | 83    | 1053          |
| 8:30 AM                         | 0                            | 29   | 2     | 0 | 13                           | 15   | 0     | 0 | 1                         | 0    | 0     | 0 | 2                         | 0    | 8     | 0 | 70    | 1040          |
| 8:35 AM                         | 0                            | 30   | 4     | 0 | 7                            | 22   | 0     | 0 | 0                         | 0    | 0     | 0 | 0                         | 0    | 4     | 0 | 67    | 1011          |
| 8:40 AM                         | 0                            | 23   | 2     | 0 | 0                            | 15   | 0     | 0 | 0                         | 0    | 1     | 0 | 2                         | 0    | 7     | 0 | 50    | 950           |
| 8:45 AM                         | 0                            | 33   | 2     | 0 | 4                            | 34   | 0     | 0 | 0                         | 0    | 1     | 0 | 2                         | 0    | 5     | 0 | 81    | 933           |
| 8:50 AM                         | 0                            | 26   | 6     | 0 | 7                            | 19   | 1     | 1 | 0                         | 0    | 0     | 0 | 9                         | 0    | 6     | 0 | 75    | 918           |
| 8:55 AM                         | 0                            | 34   | 3     | 0 | 11                           | 22   | 0     | 0 | 1                         | 0    | 0     | 0 | 2                         | 0    | 7     | 0 | 80    | 887           |
| Peak 15-Min Flowrates           | Northbound                   |      |       |   | Southbound                   |      |       |   | Eastbound                 |      |       |   | Westbound                 |      |       |   | Total |               |
|                                 | Left                         | Thru | Right | U | Left                         | Thru | Right | U | Left                      | Thru | Right | U | Left                      | Thru | Right | U |       |               |
| All Vehicles                    | 0                            | 508  | 64    | 0 | 116                          | 344  | 0     | 0 | 0                         | 0    | 0     | 0 | 68                        | 0    | 120   | 0 | 1220  |               |
| Heavy Trucks                    | 0                            | 72   | 16    |   | 20                           | 40   | 0     |   | 0                         | 0    | 0     |   | 20                        | 0    | 40    |   | 208   |               |
| Pedestrians                     |                              | 0    |       |   |                              | 0    |       |   |                           | 0    |       |   |                           | 0    |       |   | 0     |               |
| Bicycles                        | 0                            | 0    | 0     |   | 0                            | 0    | 0     |   | 0                         | 0    | 0     |   | 0                         | 0    | 0     |   | 0     |               |
| Railroad                        |                              |      |       |   |                              |      |       |   |                           |      |       |   |                           |      |       |   |       |               |
| Stopped Buses                   |                              |      |       |   |                              |      |       |   |                           |      |       |   |                           |      |       |   |       |               |

Comments:

**LOCATION:** 15. Mariposa Rd -- Stagecoach Rd  
**CITY/STATE:** San Joaquin, CA

**QC JOB #:** 14437930  
**DATE:** Thu, Jun 01 2017

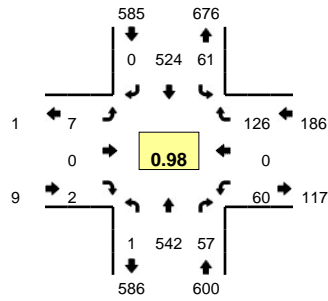

**Peak-Hour: 4:10 PM -- 5:10 PM**  
**Peak 15-Min: 4:25 PM -- 4:40 PM**

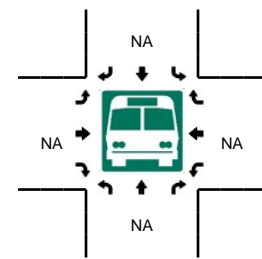
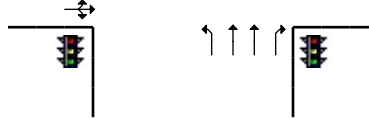
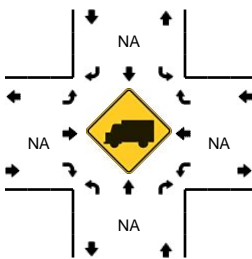
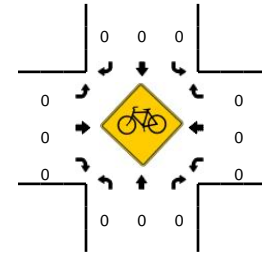
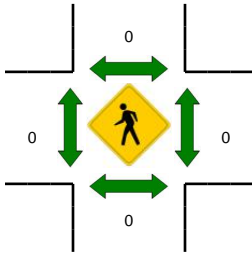
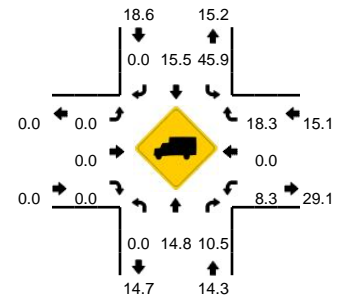

| 5-Min Count Period Beginning At | 15. Mariposa Rd (Northbound) |      |       |   | 15. Mariposa Rd (Southbound) |      |       |   | Stagecoach Rd (Eastbound) |      |       |   | Stagecoach Rd (Westbound) |      |       |   | Total | Hourly Totals |
|---------------------------------|------------------------------|------|-------|---|------------------------------|------|-------|---|---------------------------|------|-------|---|---------------------------|------|-------|---|-------|---------------|
|                                 | Left                         | Thru | Right | U | Left                         | Thru | Right | U | Left                      | Thru | Right | U | Left                      | Thru | Right | U |       |               |
| 4:00 PM                         | 0                            | 32   | 4     | 0 | 3                            | 44   | 0     | 1 | 0                         | 0    | 0     | 0 | 4                         | 0    | 10    | 0 | 98    |               |
| 4:05 PM                         | 0                            | 49   | 6     | 0 | 6                            | 37   | 0     | 1 | 0                         | 0    | 0     | 0 | 5                         | 0    | 8     | 0 | 112   |               |
| 4:10 PM                         | 0                            | 59   | 3     | 0 | 4                            | 40   | 0     | 0 | 1                         | 0    | 0     | 0 | 2                         | 0    | 8     | 0 | 117   |               |
| 4:15 PM                         | 0                            | 41   | 3     | 0 | 6                            | 55   | 0     | 0 | 0                         | 0    | 1     | 0 | 3                         | 0    | 5     | 0 | 114   |               |
| 4:20 PM                         | 0                            | 41   | 11    | 0 | 5                            | 42   | 0     | 0 | 2                         | 0    | 0     | 0 | 5                         | 0    | 6     | 0 | 112   |               |
| 4:25 PM                         | 0                            | 42   | 5     | 0 | 2                            | 54   | 0     | 0 | 0                         | 0    | 0     | 0 | 6                         | 0    | 6     | 0 | 115   |               |
| 4:30 PM                         | 0                            | 44   | 6     | 0 | 5                            | 36   | 0     | 0 | 0                         | 0    | 1     | 0 | 12                        | 0    | 9     | 0 | 113   |               |
| 4:35 PM                         | 0                            | 56   | 0     | 0 | 4                            | 47   | 0     | 0 | 1                         | 0    | 0     | 0 | 4                         | 0    | 13    | 0 | 125   |               |
| 4:40 PM                         | 0                            | 34   | 5     | 0 | 5                            | 48   | 0     | 0 | 1                         | 0    | 0     | 0 | 4                         | 0    | 7     | 0 | 104   |               |
| 4:45 PM                         | 0                            | 47   | 5     | 0 | 9                            | 42   | 0     | 0 | 0                         | 0    | 0     | 0 | 2                         | 0    | 12    | 0 | 117   |               |
| 4:50 PM                         | 0                            | 48   | 6     | 0 | 3                            | 43   | 0     | 0 | 1                         | 0    | 0     | 0 | 5                         | 0    | 6     | 0 | 112   |               |
| 4:55 PM                         | 1                            | 46   | 3     | 0 | 11                           | 23   | 0     | 0 | 1                         | 0    | 0     | 0 | 3                         | 0    | 6     | 0 | 94    | 1333          |
| 5:00 PM                         | 0                            | 46   | 2     | 0 | 3                            | 39   | 0     | 0 | 0                         | 0    | 0     | 0 | 11                        | 0    | 26    | 0 | 127   | 1362          |
| 5:05 PM                         | 0                            | 38   | 8     | 0 | 3                            | 55   | 0     | 1 | 0                         | 0    | 0     | 0 | 3                         | 0    | 22    | 0 | 130   | 1380          |
| 5:10 PM                         | 0                            | 30   | 6     | 0 | 3                            | 38   | 0     | 0 | 0                         | 0    | 0     | 0 | 8                         | 0    | 12    | 0 | 97    | 1360          |
| 5:15 PM                         | 0                            | 44   | 4     | 0 | 4                            | 52   | 0     | 0 | 0                         | 1    | 0     | 0 | 6                         | 0    | 8     | 0 | 119   | 1365          |
| 5:20 PM                         | 1                            | 38   | 8     | 0 | 4                            | 36   | 0     | 1 | 0                         | 0    | 0     | 0 | 3                         | 0    | 9     | 0 | 100   | 1353          |
| 5:25 PM                         | 0                            | 32   | 4     | 0 | 7                            | 34   | 0     | 0 | 1                         | 0    | 0     | 0 | 7                         | 0    | 9     | 0 | 94    | 1332          |
| 5:30 PM                         | 0                            | 50   | 3     | 0 | 4                            | 43   | 0     | 0 | 0                         | 0    | 0     | 0 | 3                         | 0    | 8     | 0 | 111   | 1330          |
| 5:35 PM                         | 0                            | 35   | 3     | 0 | 2                            | 40   | 0     | 0 | 0                         | 0    | 1     | 0 | 8                         | 0    | 8     | 0 | 97    | 1302          |
| 5:40 PM                         | 0                            | 31   | 4     | 0 | 3                            | 29   | 0     | 0 | 0                         | 0    | 0     | 0 | 4                         | 0    | 1     | 0 | 72    | 1270          |
| 5:45 PM                         | 0                            | 34   | 6     | 0 | 2                            | 34   | 0     | 0 | 0                         | 0    | 0     | 0 | 4                         | 0    | 6     | 0 | 86    | 1239          |
| 5:50 PM                         | 0                            | 23   | 1     | 0 | 2                            | 28   | 0     | 0 | 0                         | 0    | 0     | 0 | 1                         | 1    | 3     | 0 | 59    | 1186          |
| 5:55 PM                         | 0                            | 32   | 4     | 0 | 3                            | 26   | 0     | 1 | 0                         | 0    | 0     | 0 | 2                         | 0    | 3     | 0 | 71    | 1163          |
| Peak 15-Min Flowrates           | Northbound                   |      |       |   | Southbound                   |      |       |   | Eastbound                 |      |       |   | Westbound                 |      |       |   | Total |               |
|                                 | Left                         | Thru | Right | U | Left                         | Thru | Right | U | Left                      | Thru | Right | U | Left                      | Thru | Right | U |       |               |
| All Vehicles                    | 0                            | 568  | 44    | 0 | 44                           | 548  | 0     | 0 | 4                         | 0    | 4     | 0 | 88                        | 0    | 112   | 0 | 1412  |               |
| Heavy Trucks                    | 0                            | 92   | 4     |   | 20                           | 104  | 0     |   | 0                         | 0    | 0     |   | 4                         | 0    | 16    |   | 240   |               |
| Pedestrians                     |                              | 0    |       |   |                              | 0    |       |   |                           | 0    |       |   |                           | 0    |       |   |       | 0             |
| Bicycles                        | 0                            | 0    | 0     |   | 0                            | 0    | 0     |   | 0                         | 0    | 0     |   | 0                         | 0    | 0     |   | 0     |               |
| Railroad                        |                              |      |       |   |                              |      |       |   |                           |      |       |   |                           |      |       |   |       | 0             |
| Stopped Buses                   |                              |      |       |   |                              |      |       |   |                           |      |       |   |                           |      |       |   |       | 0             |

Comments:



**LOCATION:** 16. McDougald Blvd -- Carolyn Weston Blvd  
**CITY/STATE:** San Joaquin, CA

**QC JOB #:** 14437931  
**DATE:** Thu, Jun 01 2017

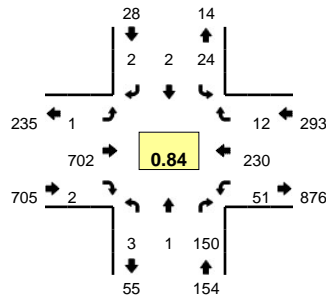

**Peak-Hour: 7:10 AM -- 8:10 AM**  
**Peak 15-Min: 7:40 AM -- 7:55 AM**

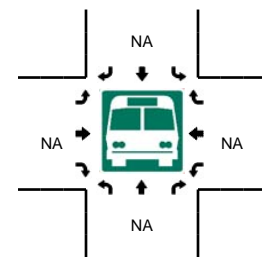
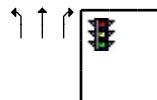
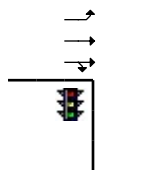
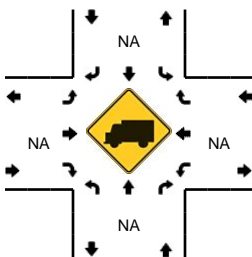
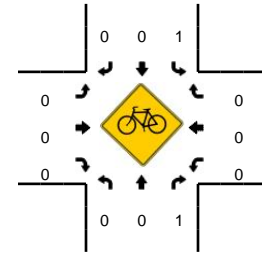
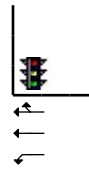
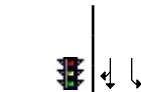
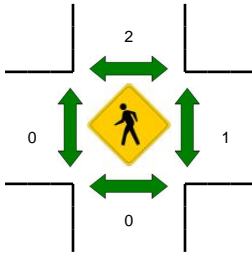
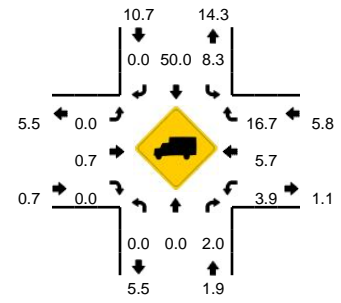

| 5-Min Count Period Beginning At | 16. McDougald Blvd (Northbound) |      |       |   | 16. McDougald Blvd (Southbound) |      |       |   | Carolyn Weston Blvd (Eastbound) |      |       |   | Carolyn Weston Blvd (Westbound) |      |       |   | Total | Hourly Totals |
|---------------------------------|---------------------------------|------|-------|---|---------------------------------|------|-------|---|---------------------------------|------|-------|---|---------------------------------|------|-------|---|-------|---------------|
|                                 | Left                            | Thru | Right | U | Left                            | Thru | Right | U | Left                            | Thru | Right | U | Left                            | Thru | Right | U |       |               |
| 7:00 AM                         | 0                               | 0    | 9     | 0 | 1                               | 0    | 0     | 0 | 0                               | 53   | 0     | 0 | 2                               | 11   | 0     | 0 | 76    |               |
| 7:05 AM                         | 0                               | 0    | 12    | 0 | 2                               | 0    | 0     | 0 | 0                               | 43   | 0     | 0 | 3                               | 12   | 0     | 0 | 72    |               |
| 7:10 AM                         | 0                               | 0    | 7     | 0 | 1                               | 0    | 0     | 0 | 0                               | 56   | 0     | 0 | 2                               | 24   | 2     | 0 | 92    |               |
| 7:15 AM                         | 0                               | 0    | 11    | 0 | 2                               | 0    | 0     | 0 | 0                               | 54   | 0     | 0 | 3                               | 10   | 2     | 0 | 82    |               |
| 7:20 AM                         | 1                               | 0    | 13    | 0 | 3                               | 0    | 0     | 0 | 0                               | 60   | 0     | 0 | 3                               | 17   | 0     | 0 | 97    |               |
| 7:25 AM                         | 0                               | 0    | 11    | 0 | 1                               | 0    | 0     | 0 | 0                               | 44   | 1     | 0 | 2                               | 20   | 0     | 0 | 80    |               |
| 7:30 AM                         | 0                               | 0    | 10    | 0 | 1                               | 1    | 0     | 0 | 0                               | 55   | 0     | 0 | 4                               | 18   | 2     | 0 | 91    |               |
| 7:35 AM                         | 0                               | 0    | 20    | 0 | 3                               | 0    | 0     | 0 | 0                               | 64   | 0     | 0 | 8                               | 20   | 0     | 0 | 115   |               |
| 7:40 AM                         | 0                               | 0    | 12    | 0 | 3                               | 0    | 1     | 0 | 0                               | 76   | 0     | 0 | 4                               | 15   | 1     | 0 | 112   |               |
| 7:45 AM                         | 0                               | 0    | 18    | 0 | 3                               | 0    | 0     | 0 | 0                               | 79   | 0     | 0 | 4                               | 16   | 0     | 0 | 120   |               |
| 7:50 AM                         | 0                               | 0    | 20    | 0 | 1                               | 1    | 0     | 0 | 0                               | 67   | 1     | 0 | 6                               | 25   | 0     | 0 | 121   |               |
| 7:55 AM                         | 2                               | 0    | 9     | 0 | 0                               | 0    | 0     | 0 | 0                               | 47   | 0     | 0 | 2                               | 21   | 1     | 0 | 82    | 1140          |
| 8:00 AM                         | 0                               | 0    | 9     | 0 | 2                               | 0    | 0     | 0 | 1                               | 54   | 0     | 0 | 7                               | 22   | 3     | 0 | 98    | 1162          |
| 8:05 AM                         | 0                               | 0    | 10    | 0 | 4                               | 0    | 1     | 0 | 0                               | 46   | 0     | 0 | 6                               | 22   | 1     | 0 | 90    | 1180          |
| 8:10 AM                         | 0                               | 0    | 10    | 0 | 3                               | 0    | 0     | 0 | 0                               | 39   | 0     | 0 | 6                               | 30   | 0     | 0 | 88    | 1176          |
| 8:15 AM                         | 0                               | 0    | 10    | 0 | 1                               | 0    | 1     | 0 | 0                               | 41   | 0     | 0 | 7                               | 23   | 1     | 0 | 84    | 1178          |
| 8:20 AM                         | 0                               | 0    | 8     | 0 | 0                               | 1    | 0     | 0 | 0                               | 38   | 0     | 0 | 5                               | 26   | 1     | 0 | 79    | 1160          |
| 8:25 AM                         | 0                               | 0    | 13    | 0 | 0                               | 0    | 0     | 0 | 0                               | 47   | 0     | 0 | 3                               | 20   | 0     | 0 | 83    | 1163          |
| 8:30 AM                         | 0                               | 0    | 7     | 0 | 2                               | 0    | 0     | 0 | 0                               | 54   | 0     | 0 | 6                               | 24   | 1     | 0 | 94    | 1166          |
| 8:35 AM                         | 1                               | 0    | 7     | 0 | 0                               | 0    | 0     | 0 | 0                               | 47   | 0     | 0 | 5                               | 25   | 1     | 0 | 86    | 1137          |
| 8:40 AM                         | 1                               | 0    | 17    | 0 | 1                               | 0    | 0     | 0 | 0                               | 37   | 0     | 0 | 6                               | 23   | 0     | 0 | 85    | 1110          |
| 8:45 AM                         | 0                               | 0    | 9     | 0 | 2                               | 0    | 0     | 0 | 0                               | 70   | 0     | 0 | 6                               | 19   | 2     | 0 | 108   | 1098          |
| 8:50 AM                         | 0                               | 0    | 9     | 0 | 2                               | 1    | 0     | 0 | 0                               | 55   | 0     | 0 | 2                               | 21   | 2     | 0 | 92    | 1069          |
| 8:55 AM                         | 0                               | 0    | 9     | 0 | 1                               | 0    | 0     | 0 | 0                               | 45   | 2     | 0 | 9                               | 17   | 0     | 0 | 83    | 1070          |
| Peak 15-Min Flowrates           | Northbound                      |      |       |   | Southbound                      |      |       |   | Eastbound                       |      |       |   | Westbound                       |      |       |   | Total |               |
|                                 | Left                            | Thru | Right | U | Left                            | Thru | Right | U | Left                            | Thru | Right | U | Left                            | Thru | Right | U |       |               |
| All Vehicles                    | 0                               | 0    | 200   | 0 | 28                              | 4    | 4     | 0 | 0                               | 888  | 4     | 0 | 56                              | 224  | 4     | 0 | 1412  |               |
| Heavy Trucks                    | 0                               | 0    | 4     | 0 | 0                               | 4    | 0     | 0 | 0                               | 4    | 0     | 0 | 4                               | 12   | 4     | 0 | 32    |               |
| Pedestrians                     | 0                               | 0    | 0     | 0 | 0                               | 4    | 0     | 0 | 0                               | 0    | 0     | 0 | 0                               | 4    | 0     | 0 | 8     |               |
| Bicycles                        | 0                               | 0    | 1     | 0 | 0                               | 0    | 0     | 0 | 0                               | 0    | 0     | 0 | 0                               | 0    | 0     | 0 | 1     |               |
| Railroad                        |                                 |      |       |   |                                 |      |       |   |                                 |      |       |   |                                 |      |       |   |       |               |
| Stopped Buses                   |                                 |      |       |   |                                 |      |       |   |                                 |      |       |   |                                 |      |       |   |       |               |

Comments:

**LOCATION:** 16. McDougald Blvd -- Carolyn Weston Blvd  
**CITY/STATE:** San Joaquin, CA

**QC JOB #:** 14437932  
**DATE:** Thu, Jun 01 2017

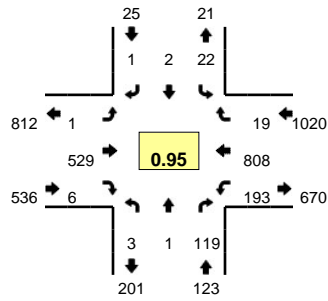

**Peak-Hour: 5:00 PM -- 6:00 PM**  
**Peak 15-Min: 5:35 PM -- 5:50 PM**

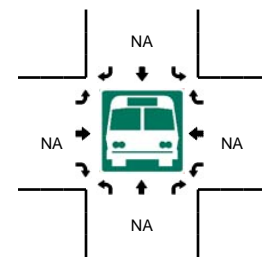
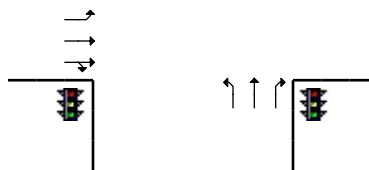
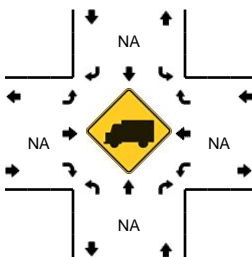
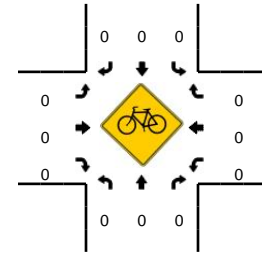
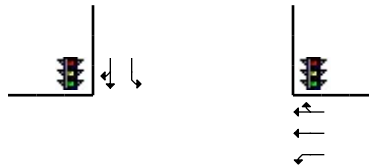
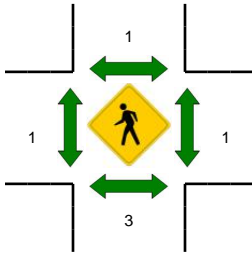
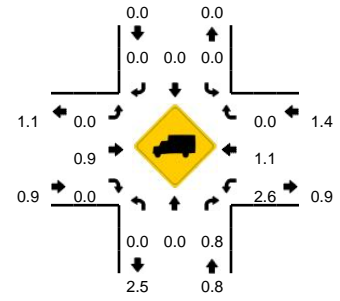

| 5-Min Count Period Beginning At | 16. McDougald Blvd (Northbound) |      |       |   | 16. McDougald Blvd (Southbound) |      |       |   | Carolyn Weston Blvd (Eastbound) |      |       |   | Carolyn Weston Blvd (Westbound) |      |       |   | Total | Hourly Totals |
|---------------------------------|---------------------------------|------|-------|---|---------------------------------|------|-------|---|---------------------------------|------|-------|---|---------------------------------|------|-------|---|-------|---------------|
|                                 | Left                            | Thru | Right | U | Left                            | Thru | Right | U | Left                            | Thru | Right | U | Left                            | Thru | Right | U |       |               |
| 4:00 PM                         | 1                               | 2    | 6     | 0 | 1                               | 1    | 0     | 0 | 0                               | 42   | 1     | 0 | 12                              | 63   | 6     | 0 | 135   |               |
| 4:05 PM                         | 1                               | 0    | 10    | 0 | 3                               | 0    | 1     | 0 | 0                               | 49   | 0     | 0 | 17                              | 40   | 3     | 0 | 124   |               |
| 4:10 PM                         | 1                               | 0    | 8     | 0 | 1                               | 0    | 0     | 0 | 0                               | 35   | 1     | 0 | 13                              | 66   | 1     | 0 | 126   |               |
| 4:15 PM                         | 0                               | 0    | 8     | 0 | 1                               | 0    | 0     | 0 | 0                               | 32   | 0     | 0 | 13                              | 66   | 3     | 0 | 123   |               |
| 4:20 PM                         | 1                               | 0    | 5     | 0 | 2                               | 0    | 0     | 0 | 0                               | 28   | 0     | 0 | 18                              | 67   | 1     | 0 | 122   |               |
| 4:25 PM                         | 0                               | 0    | 4     | 0 | 1                               | 0    | 1     | 0 | 0                               | 33   | 0     | 0 | 15                              | 51   | 3     | 0 | 108   |               |
| 4:30 PM                         | 0                               | 0    | 13    | 0 | 3                               | 0    | 0     | 0 | 0                               | 40   | 0     | 0 | 15                              | 54   | 3     | 0 | 128   |               |
| 4:35 PM                         | 0                               | 1    | 11    | 0 | 0                               | 0    | 0     | 0 | 0                               | 55   | 1     | 0 | 10                              | 48   | 2     | 0 | 128   |               |
| 4:40 PM                         | 1                               | 0    | 12    | 0 | 3                               | 0    | 0     | 0 | 0                               | 54   | 1     | 0 | 21                              | 67   | 3     | 0 | 162   |               |
| 4:45 PM                         | 0                               | 0    | 9     | 0 | 0                               | 0    | 0     | 0 | 0                               | 39   | 0     | 0 | 11                              | 59   | 2     | 0 | 120   |               |
| 4:50 PM                         | 1                               | 0    | 4     | 0 | 2                               | 0    | 0     | 0 | 1                               | 56   | 1     | 0 | 9                               | 73   | 1     | 0 | 148   |               |
| 4:55 PM                         | 1                               | 0    | 5     | 0 | 2                               | 0    | 0     | 0 | 0                               | 32   | 0     | 0 | 14                              | 71   | 2     | 0 | 127   | 1551          |
| 5:00 PM                         | 0                               | 1    | 6     | 0 | 3                               | 0    | 0     | 0 | 0                               | 45   | 1     | 0 | 10                              | 59   | 0     | 0 | 125   | 1541          |
| 5:05 PM                         | 0                               | 0    | 10    | 0 | 4                               | 0    | 0     | 0 | 0                               | 43   | 0     | 0 | 18                              | 71   | 1     | 0 | 147   | 1564          |
| 5:10 PM                         | 0                               | 0    | 6     | 0 | 0                               | 0    | 0     | 0 | 1                               | 44   | 3     | 0 | 11                              | 77   | 3     | 0 | 145   | 1583          |
| 5:15 PM                         | 0                               | 0    | 14    | 0 | 1                               | 0    | 0     | 0 | 0                               | 38   | 0     | 0 | 18                              | 69   | 1     | 0 | 141   | 1601          |
| 5:20 PM                         | 0                               | 0    | 10    | 0 | 4                               | 1    | 0     | 0 | 0                               | 37   | 1     | 0 | 23                              | 70   | 0     | 0 | 146   | 1625          |
| 5:25 PM                         | 1                               | 0    | 9     | 0 | 1                               | 1    | 0     | 0 | 0                               | 45   | 0     | 0 | 15                              | 63   | 1     | 0 | 136   | 1653          |
| 5:30 PM                         | 1                               | 0    | 7     | 0 | 2                               | 0    | 0     | 0 | 0                               | 50   | 0     | 0 | 12                              | 66   | 0     | 0 | 138   | 1663          |
| 5:35 PM                         | 1                               | 0    | 6     | 0 | 3                               | 0    | 1     | 0 | 0                               | 52   | 0     | 0 | 16                              | 80   | 4     | 0 | 163   | 1698          |
| 5:40 PM                         | 0                               | 0    | 10    | 0 | 2                               | 0    | 0     | 0 | 0                               | 45   | 0     | 0 | 15                              | 56   | 1     | 0 | 129   | 1665          |
| 5:45 PM                         | 0                               | 0    | 11    | 0 | 0                               | 0    | 0     | 0 | 0                               | 42   | 1     | 0 | 25                              | 75   | 2     | 0 | 156   | 1701          |
| 5:50 PM                         | 0                               | 0    | 13    | 0 | 1                               | 0    | 0     | 0 | 0                               | 46   | 0     | 0 | 15                              | 62   | 1     | 0 | 138   | 1691          |
| 5:55 PM                         | 0                               | 0    | 17    | 0 | 1                               | 0    | 0     | 0 | 0                               | 42   | 0     | 0 | 15                              | 60   | 5     | 0 | 140   | 1704          |
| Peak 15-Min Flowrates           | Northbound                      |      |       |   | Southbound                      |      |       |   | Eastbound                       |      |       |   | Westbound                       |      |       |   | Total |               |
|                                 | Left                            | Thru | Right | U | Left                            | Thru | Right | U | Left                            | Thru | Right | U | Left                            | Thru | Right | U |       |               |
| All Vehicles                    | 4                               | 0    | 108   | 0 | 20                              | 0    | 4     | 0 | 0                               | 556  | 4     | 0 | 224                             | 844  | 28    | 0 | 1792  |               |
| Heavy Trucks                    | 0                               | 0    | 0     | 0 | 0                               | 0    | 0     | 0 | 0                               | 8    | 0     | 0 | 0                               | 12   | 0     | 0 | 20    |               |
| Pedestrians                     |                                 | 8    |       |   |                                 | 0    |       |   |                                 | 0    |       |   |                                 | 0    |       |   | 8     |               |
| Bicycles                        | 0                               | 0    | 0     |   | 0                               | 0    | 0     |   | 0                               | 0    | 0     |   | 0                               | 0    | 0     |   | 0     |               |
| Railroad                        |                                 |      |       |   |                                 |      |       |   |                                 |      |       |   |                                 |      |       |   |       |               |
| Stopped Buses                   |                                 |      |       |   |                                 |      |       |   |                                 |      |       |   |                                 |      |       |   |       |               |

Comments:

**LOCATION:** 17. Airport Way -- Ralph Rd  
**CITY/STATE:** San Joaquin, CA

**QC JOB #:** 14437933  
**DATE:** Thu, Jun 01 2017

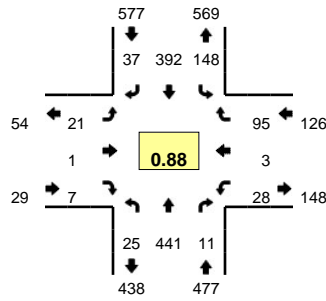

**Peak-Hour: 7:20 AM -- 8:20 AM**  
**Peak 15-Min: 7:45 AM -- 8:00 AM**

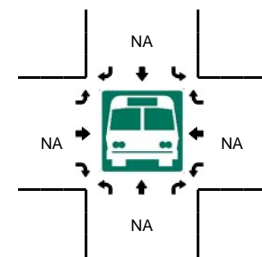
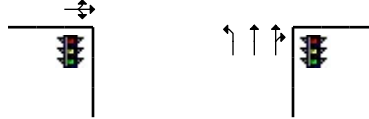
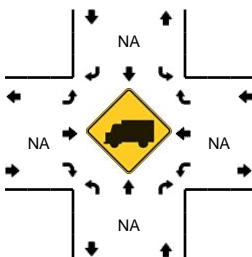
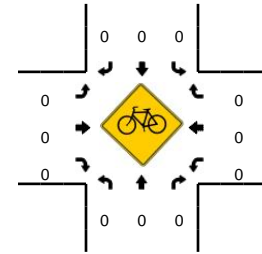
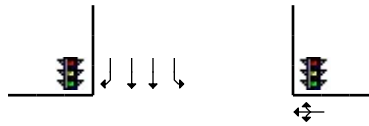
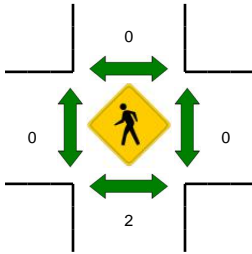
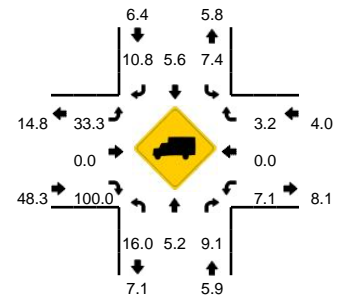

| 5-Min Count Period Beginning At | 17. Airport Way (Northbound) |      |       |   | 17. Airport Way (Southbound) |      |       |    | Ralph Rd (Eastbound) |      |       |   | Ralph Rd (Westbound) |      |       |   | Total | Hourly Totals |
|---------------------------------|------------------------------|------|-------|---|------------------------------|------|-------|----|----------------------|------|-------|---|----------------------|------|-------|---|-------|---------------|
|                                 | Left                         | Thru | Right | U | Left                         | Thru | Right | U  | Left                 | Thru | Right | U | Left                 | Thru | Right | U |       |               |
| 7:00 AM                         | 0                            | 20   | 0     | 6 | 4                            | 49   | 1     | 1  | 2                    | 0    | 0     | 0 | 2                    | 0    | 6     | 0 | 91    |               |
| 7:05 AM                         | 1                            | 34   | 1     | 5 | 3                            | 36   | 5     | 2  | 3                    | 0    | 0     | 0 | 0                    | 0    | 9     | 0 | 99    |               |
| 7:10 AM                         | 1                            | 27   | 1     | 6 | 5                            | 33   | 0     | 1  | 1                    | 0    | 0     | 0 | 1                    | 0    | 8     | 0 | 84    |               |
| 7:15 AM                         | 0                            | 36   | 1     | 9 | 6                            | 30   | 1     | 1  | 0                    | 0    | 1     | 0 | 4                    | 0    | 5     | 0 | 94    |               |
| 7:20 AM                         | 0                            | 32   | 2     | 4 | 4                            | 39   | 4     | 2  | 1                    | 0    | 0     | 0 | 2                    | 1    | 6     | 0 | 97    |               |
| 7:25 AM                         | 0                            | 28   | 2     | 1 | 11                           | 43   | 3     | 0  | 3                    | 0    | 1     | 0 | 7                    | 0    | 10    | 0 | 109   |               |
| 7:30 AM                         | 1                            | 35   | 0     | 1 | 11                           | 25   | 2     | 1  | 1                    | 0    | 3     | 0 | 1                    | 0    | 9     | 0 | 90    |               |
| 7:35 AM                         | 2                            | 45   | 0     | 0 | 9                            | 35   | 3     | 1  | 2                    | 0    | 0     | 0 | 0                    | 0    | 5     | 0 | 102   |               |
| 7:40 AM                         | 3                            | 27   | 1     | 0 | 6                            | 25   | 6     | 0  | 0                    | 0    | 0     | 0 | 4                    | 0    | 5     | 0 | 77    |               |
| 7:45 AM                         | 1                            | 42   | 1     | 0 | 12                           | 43   | 3     | 1  | 1                    | 0    | 0     | 0 | 1                    | 1    | 13    | 0 | 119   |               |
| 7:50 AM                         | 0                            | 44   | 1     | 2 | 17                           | 36   | 3     | 1  | 1                    | 0    | 1     | 0 | 6                    | 0    | 11    | 0 | 123   |               |
| 7:55 AM                         | 2                            | 36   | 0     | 0 | 15                           | 34   | 1     | 1  | 1                    | 1    | 0     | 0 | 2                    | 0    | 8     | 0 | 101   | 1186          |
| 8:00 AM                         | 0                            | 42   | 2     | 2 | 6                            | 25   | 3     | 0  | 2                    | 0    | 0     | 0 | 1                    | 0    | 3     | 0 | 86    | 1181          |
| 8:05 AM                         | 5                            | 44   | 1     | 0 | 14                           | 30   | 3     | 1  | 4                    | 0    | 0     | 0 | 1                    | 0    | 8     | 0 | 111   | 1193          |
| 8:10 AM                         | 0                            | 30   | 0     | 0 | 17                           | 27   | 3     | 1  | 2                    | 0    | 1     | 0 | 1                    | 1    | 7     | 0 | 90    | 1199          |
| 8:15 AM                         | 0                            | 36   | 1     | 1 | 14                           | 30   | 3     | 3  | 3                    | 0    | 1     | 0 | 2                    | 0    | 10    | 0 | 104   | 1209          |
| 8:20 AM                         | 1                            | 21   | 0     | 0 | 13                           | 32   | 7     | 2  | 2                    | 0    | 3     | 0 | 4                    | 0    | 3     | 0 | 88    | 1200          |
| 8:25 AM                         | 0                            | 24   | 2     | 0 | 7                            | 12   | 7     | 2  | 5                    | 1    | 0     | 0 | 1                    | 1    | 8     | 0 | 70    | 1161          |
| 8:30 AM                         | 1                            | 30   | 1     | 0 | 8                            | 27   | 3     | 2  | 3                    | 0    | 0     | 0 | 3                    | 0    | 7     | 0 | 85    | 1156          |
| 8:35 AM                         | 1                            | 23   | 1     | 2 | 9                            | 22   | 4     | 1  | 3                    | 0    | 5     | 0 | 4                    | 1    | 6     | 0 | 82    | 1136          |
| 8:40 AM                         | 1                            | 24   | 2     | 1 | 5                            | 12   | 3     | 1  | 0                    | 0    | 0     | 0 | 1                    | 0    | 2     | 0 | 52    | 1111          |
| 8:45 AM                         | 1                            | 23   | 0     | 1 | 7                            | 15   | 5     | 0  | 5                    | 0    | 0     | 0 | 2                    | 0    | 3     | 0 | 62    | 1054          |
| 8:50 AM                         | 4                            | 27   | 1     | 0 | 6                            | 20   | 5     | 0  | 1                    | 0    | 1     | 0 | 1                    | 1    | 7     | 0 | 74    | 1005          |
| 8:55 AM                         | 2                            | 17   | 0     | 1 | 2                            | 20   | 8     | 0  | 0                    | 0    | 0     | 0 | 2                    | 1    | 3     | 0 | 56    | 960           |
| Peak 15-Min Flowrates           | Northbound                   |      |       |   | Southbound                   |      |       |    | Eastbound            |      |       |   | Westbound            |      |       |   | Total |               |
|                                 | Left                         | Thru | Right | U | Left                         | Thru | Right | U  | Left                 | Thru | Right | U | Left                 | Thru | Right | U |       |               |
| All Vehicles                    | 12                           | 488  | 8     | 8 | 176                          | 452  | 28    | 12 | 12                   | 4    | 4     | 0 | 36                   | 4    | 128   | 0 | 1372  |               |
| Heavy Trucks                    | 4                            | 20   | 0     |   | 16                           | 20   | 0     |    | 8                    | 0    | 4     |   | 4                    | 0    | 0     |   | 76    |               |
| Pedestrians                     |                              | 8    |       |   |                              | 0    |       |    |                      | 0    |       |   |                      | 0    |       |   | 8     |               |
| Bicycles                        | 0                            | 0    | 0     |   | 0                            | 0    | 0     |    | 0                    | 0    | 0     |   | 0                    | 0    | 0     |   | 0     |               |
| Railroad                        |                              |      |       |   |                              |      |       |    |                      |      |       |   |                      |      |       |   |       |               |
| Stopped Buses                   |                              |      |       |   |                              |      |       |    |                      |      |       |   |                      |      |       |   |       |               |

Comments:

**LOCATION:** 17. Airport Way -- Ralph Rd  
**CITY/STATE:** San Joaquin, CA

**QC JOB #:** 14437934  
**DATE:** Thu, Jun 01 2017

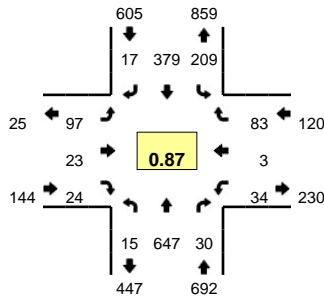

**Peak-Hour: 4:00 PM -- 5:00 PM**  
**Peak 15-Min: 4:05 PM -- 4:20 PM**

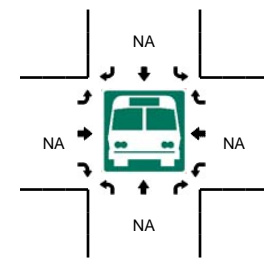
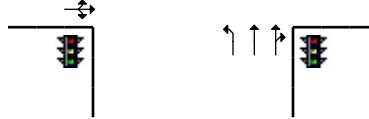
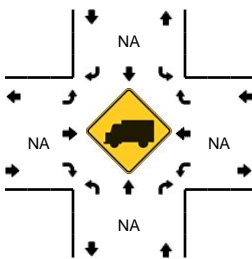
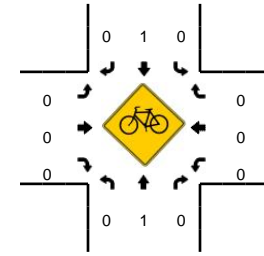
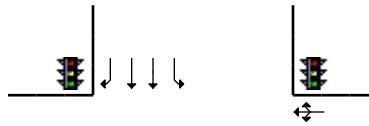
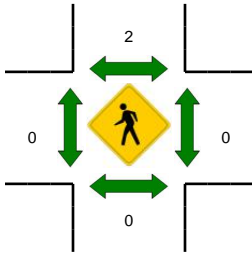
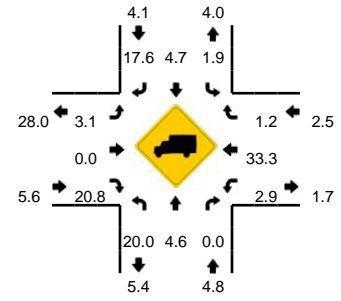

| 5-Min Count Period Beginning At | 17. Airport Way (Northbound) |      |       |    | 17. Airport Way (Southbound) |      |       |    | Ralph Rd (Eastbound) |      |       |   | Ralph Rd (Westbound) |      |       |   | Total | Hourly Totals |
|---------------------------------|------------------------------|------|-------|----|------------------------------|------|-------|----|----------------------|------|-------|---|----------------------|------|-------|---|-------|---------------|
|                                 | Left                         | Thru | Right | U  | Left                         | Thru | Right | U  | Left                 | Thru | Right | U | Left                 | Thru | Right | U |       |               |
| 4:00 PM                         | 0                            | 53   | 0     | 1  | 10                           | 27   | 1     | 2  | 17                   | 3    | 3     | 0 | 2                    | 0    | 2     | 0 | 121   |               |
| 4:05 PM                         | 1                            | 76   | 1     | 2  | 13                           | 29   | 1     | 2  | 28                   | 8    | 3     | 0 | 3                    | 1    | 6     | 0 | 174   |               |
| 4:10 PM                         | 2                            | 63   | 1     | 0  | 16                           | 27   | 2     | 1  | 10                   | 3    | 2     | 0 | 3                    | 0    | 9     | 0 | 139   |               |
| 4:15 PM                         | 0                            | 55   | 1     | 3  | 18                           | 38   | 1     | 3  | 6                    | 1    | 2     | 0 | 3                    | 1    | 5     | 0 | 137   |               |
| 4:20 PM                         | 1                            | 52   | 2     | 0  | 16                           | 24   | 1     | 1  | 3                    | 1    | 2     | 0 | 1                    | 0    | 6     | 0 | 110   |               |
| 4:25 PM                         | 1                            | 38   | 2     | 0  | 22                           | 31   | 4     | 5  | 1                    | 1    | 2     | 0 | 8                    | 0    | 8     | 0 | 123   |               |
| 4:30 PM                         | 0                            | 51   | 4     | 0  | 12                           | 34   | 1     | 3  | 8                    | 1    | 2     | 0 | 2                    | 0    | 6     | 0 | 124   |               |
| 4:35 PM                         | 0                            | 71   | 3     | 2  | 17                           | 24   | 0     | 1  | 15                   | 2    | 3     | 0 | 3                    | 0    | 9     | 0 | 150   |               |
| 4:40 PM                         | 0                            | 66   | 5     | 1  | 9                            | 48   | 2     | 4  | 5                    | 0    | 1     | 0 | 2                    | 0    | 10    | 0 | 153   |               |
| 4:45 PM                         | 0                            | 37   | 0     | 0  | 19                           | 41   | 0     | 5  | 0                    | 0    | 0     | 0 | 3                    | 1    | 10    | 0 | 116   |               |
| 4:50 PM                         | 0                            | 46   | 8     | 1  | 15                           | 28   | 2     | 2  | 2                    | 2    | 3     | 0 | 1                    | 0    | 5     | 0 | 115   |               |
| 4:55 PM                         | 0                            | 39   | 3     | 0  | 10                           | 28   | 2     | 3  | 2                    | 1    | 1     | 0 | 3                    | 0    | 7     | 0 | 99    | 1561          |
| 5:00 PM                         | 0                            | 46   | 4     | 1  | 11                           | 36   | 0     | 1  | 4                    | 0    | 0     | 0 | 3                    | 1    | 6     | 0 | 113   | 1553          |
| 5:05 PM                         | 0                            | 59   | 7     | 0  | 10                           | 24   | 1     | 1  | 5                    | 0    | 0     | 0 | 0                    | 0    | 9     | 0 | 116   | 1495          |
| 5:10 PM                         | 0                            | 64   | 2     | 2  | 16                           | 44   | 0     | 4  | 4                    | 0    | 0     | 0 | 5                    | 0    | 6     | 0 | 147   | 1503          |
| 5:15 PM                         | 0                            | 50   | 8     | 0  | 15                           | 30   | 1     | 0  | 3                    | 0    | 2     | 0 | 2                    | 0    | 3     | 0 | 114   | 1480          |
| 5:20 PM                         | 1                            | 25   | 1     | 1  | 19                           | 36   | 3     | 2  | 2                    | 0    | 0     | 0 | 1                    | 0    | 2     | 0 | 93    | 1463          |
| 5:25 PM                         | 0                            | 41   | 0     | 1  | 13                           | 35   | 1     | 0  | 1                    | 0    | 0     | 0 | 3                    | 0    | 6     | 0 | 101   | 1441          |
| 5:30 PM                         | 0                            | 27   | 2     | 0  | 24                           | 31   | 1     | 4  | 4                    | 1    | 3     | 0 | 2                    | 1    | 5     | 0 | 105   | 1422          |
| 5:35 PM                         | 1                            | 34   | 2     | 0  | 17                           | 29   | 0     | 3  | 3                    | 1    | 2     | 0 | 4                    | 0    | 9     | 0 | 105   | 1377          |
| 5:40 PM                         | 0                            | 22   | 1     | 1  | 17                           | 30   | 2     | 0  | 3                    | 0    | 1     | 0 | 1                    | 1    | 9     | 0 | 88    | 1312          |
| 5:45 PM                         | 0                            | 33   | 1     | 0  | 13                           | 27   | 1     | 3  | 4                    | 0    | 0     | 0 | 1                    | 0    | 1     | 0 | 84    | 1280          |
| 5:50 PM                         | 1                            | 32   | 1     | 0  | 13                           | 29   | 1     | 1  | 2                    | 0    | 1     | 0 | 2                    | 1    | 2     | 0 | 86    | 1251          |
| 5:55 PM                         | 2                            | 37   | 1     | 1  | 13                           | 20   | 0     | 4  | 1                    | 0    | 0     | 0 | 0                    | 0    | 4     | 0 | 83    | 1235          |
| Peak 15-Min Flowrates           | Northbound                   |      |       |    | Southbound                   |      |       |    | Eastbound            |      |       |   | Westbound            |      |       |   | Total |               |
|                                 | Left                         | Thru | Right | U  | Left                         | Thru | Right | U  | Left                 | Thru | Right | U | Left                 | Thru | Right | U |       |               |
| All Vehicles                    | 12                           | 776  | 12    | 20 | 188                          | 376  | 16    | 24 | 176                  | 48   | 28    | 0 | 36                   | 8    | 80    | 0 | 1800  |               |
| Heavy Trucks                    | 8                            | 20   | 0     |    | 4                            | 28   | 0     |    | 4                    | 0    | 8     |   | 0                    | 4    | 0     |   | 76    |               |
| Pedestrians                     |                              | 0    |       |    |                              | 4    |       |    |                      | 0    |       |   |                      | 0    |       |   | 4     |               |
| Bicycles                        | 0                            | 0    | 0     |    | 0                            | 0    | 0     |    | 0                    | 0    | 0     |   | 0                    | 0    | 0     |   | 0     |               |
| Railroad                        |                              |      |       |    |                              |      |       |    |                      |      |       |   |                      |      |       |   |       |               |
| Stopped Buses                   |                              |      |       |    |                              |      |       |    |                      |      |       |   |                      |      |       |   |       |               |

Comments:

**LOCATION:** 18. Airport way -- Arch Airport Road/Sperry Road  
**CITY/STATE:** San Joaquin, CA

**QC JOB #:** 14437935  
**DATE:** Thu, Jun 01 2017

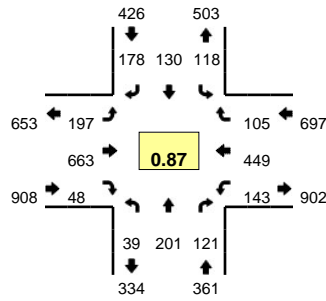

**Peak-Hour: 7:25 AM -- 8:25 AM**  
**Peak 15-Min: 7:45 AM -- 8:00 AM**

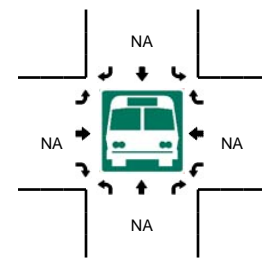
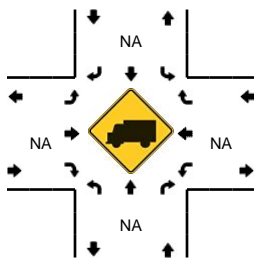
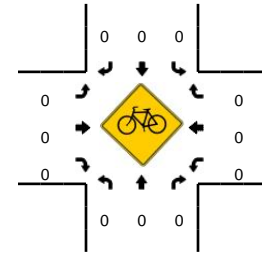
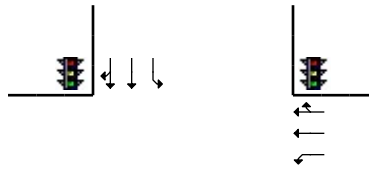
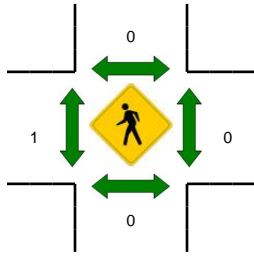
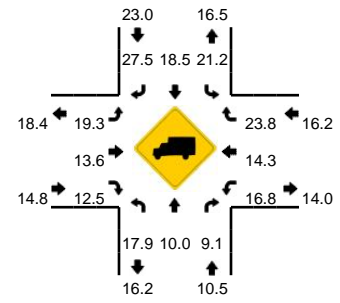

| 5-Min Count Period Beginning At | 18. Airport way (Northbound) |      |       |    | 18. Airport way (Southbound) |      |       |   | Arch Airport Road/Sperry Road (Eastbound) |      |       |   | Arch Airport Road/Sperry Road (Westbound) |      |       |   | Total | Hourly Totals |
|---------------------------------|------------------------------|------|-------|----|------------------------------|------|-------|---|---|------|-------|---|---|------|-------|---|-------|---------------|
|                                 | Left                         | Thru | Right | U  | Left                         | Thru | Right | U | Left                                      | Thru | Right | U | Left                                      | Thru | Right | U |       |               |
| 7:00 AM                         | 0                            | 8    | 7     | 0  | 3                            | 9    | 12    | 0 | 10  | 42   | 0     | 0 | 5   | 43   | 11    | 0 | 150   |               |
| 7:05 AM                         | 0                            | 19   | 5     | 1  | 9                            | 8    | 7     | 0 | 12  | 36   | 3     | 0 | 6   | 28   | 5     | 0 | 139   |               |
| 7:10 AM                         | 4                            | 15   | 8     | 0  | 5                            | 6    | 8     | 0 | 19  | 50   | 5     | 0 | 6   | 32   | 10    | 0 | 168   |               |
| 7:15 AM                         | 0                            | 24   | 11    | 1  | 5                            | 11   | 13    | 0 | 22  | 29   | 2     | 0 | 7   | 24   | 13    | 0 | 162   |               |
| 7:20 AM                         | 1                            | 17   | 9     | 1  | 4                            | 6    | 11    | 1 | 13  | 39   | 0     | 0 | 4   | 36   | 12    | 0 | 154   |               |
| 7:25 AM                         | 2                            | 22   | 3     | 0  | 4                            | 14   | 16    | 0 | 17  | 54   | 8     | 0 | 11  | 25   | 9     | 0 | 185   |               |
| 7:30 AM                         | 3                            | 7    | 7     | 0  | 7                            | 17   | 21    | 0 | 17  | 63   | 2     | 0 | 13  | 37   | 9     | 0 | 203   |               |
| 7:35 AM                         | 2                            | 19   | 11    | 0  | 5                            | 12   | 15    | 0 | 18  | 57   | 2     | 0 | 8   | 44   | 6     | 0 | 199   |               |
| 7:40 AM                         | 3                            | 15   | 9     | 0  | 16                           | 13   | 12    | 0 | 18  | 72   | 6     | 0 | 6   | 47   | 14    | 0 | 231   |               |
| 7:45 AM                         | 1                            | 26   | 20    | 3  | 7                            | 4    | 16    | 0 | 13  | 73   | 3     | 0 | 16  | 40   | 9     | 0 | 231   |               |
| 7:50 AM                         | 4                            | 22   | 19    | 0  | 10                           | 11   | 21    | 0 | 16  | 51   | 5     | 0 | 7   | 38   | 11    | 0 | 215   |               |
| 7:55 AM                         | 1                            | 7    | 10    | 3  | 11                           | 10   | 13    | 0 | 16  | 86   | 6     | 0 | 13  | 53   | 10    | 0 | 239   | 2276          |
| 8:00 AM                         | 2                            | 27   | 4     | 3  | 18                           | 11   | 15    | 0 | 19  | 37   | 5     | 0 | 18  | 25   | 6     | 0 | 190   | 2316          |
| 8:05 AM                         | 1                            | 13   | 13    | 0  | 9                            | 13   | 14    | 0 | 24  | 40   | 1     | 0 | 13  | 31   | 9     | 0 | 181   | 2358          |
| 8:10 AM                         | 4                            | 16   | 10    | 4  | 6                            | 8    | 8     | 0 | 11  | 44   | 1     | 0 | 15  | 31   | 7     | 0 | 165   | 2355          |
| 8:15 AM                         | 1                            | 10   | 5     | 0  | 13                           | 8    | 13    | 0 | 18  | 44   | 4     | 0 | 10  | 41   | 9     | 0 | 176   | 2369          |
| 8:20 AM                         | 2                            | 17   | 10    | 0  | 12                           | 9    | 14    | 0 | 10  | 42   | 5     | 0 | 13  | 37   | 6     | 0 | 177   | 2392          |
| 8:25 AM                         | 1                            | 18   | 8     | 0  | 11                           | 14   | 14    | 0 | 12  | 32   | 4     | 0 | 17  | 27   | 10    | 0 | 168   | 2375          |
| 8:30 AM                         | 1                            | 15   | 9     | 0  | 9                            | 11   | 10    | 1 | 15  | 26   | 4     | 0 | 7   | 26   | 11    | 0 | 145   | 2317          |
| 8:35 AM                         | 2                            | 19   | 6     | 0  | 5                            | 11   | 18    | 2 | 13  | 36   | 1     | 0 | 8   | 13   | 6     | 0 | 140   | 2258          |
| 8:40 AM                         | 6                            | 16   | 5     | 0  | 9                            | 11   | 10    | 0 | 9   | 29   | 2     | 0 | 4   | 27   | 4     | 0 | 132   | 2159          |
| 8:45 AM                         | 0                            | 14   | 7     | 2  | 7                            | 6    | 9     | 0 | 16  | 35   | 5     | 0 | 11  | 20   | 3     | 0 | 135   | 2063          |
| 8:50 AM                         | 4                            | 14   | 11    | 0  | 7                            | 13   | 15    | 0 | 6   | 20   | 2     | 0 | 8   | 30   | 5     | 0 | 135   | 1983          |
| 8:55 AM                         | 4                            | 9    | 8     | 0  | 13                           | 8    | 7     | 0 | 13  | 26   | 2     | 0 | 6   | 28   | 9     | 1 | 134   | 1878          |
| Peak 15-Min Flowrates           | Northbound                   |      |       |    | Southbound                   |      |       |   | Eastbound                                 |      |       |   | Westbound                                 |      |       |   | Total |               |
|                                 | Left                         | Thru | Right | U  | Left                         | Thru | Right | U | Left                                      | Thru | Right | U | Left                                      | Thru | Right | U |       |               |
| All Vehicles                    | 24                           | 220  | 196   | 24 | 112                          | 100  | 200   | 0 | 180                                       | 840  | 56    | 0 | 144                                       | 524  | 120   | 0 | 2740  |               |
| Heavy Trucks                    | 0                            | 32   | 20    |    | 24                           | 20   | 44    |   | 36  | 76   | 8     |   | 16  | 72   | 24    |   | 372   |               |
| Pedestrians                     |                              | 0    |       |    |                              | 0    |       |   |   | 4    |       |   |   | 0    |       |   | 4     |               |
| Bicycles                        | 0                            | 0    | 0     |    | 0                            | 0    | 0     |   | 0   | 0    | 0     |   | 0   | 0    | 0     |   | 0     |               |
| Railroad                        |                              |      |       |    |                              |      |       |   |   |      |       |   |   |      |       |   |       |               |
| Stopped Buses                   |                              |      |       |    |                              |      |       |   |   |      |       |   |   |      |       |   |       |               |

Comments:

**LOCATION:** 18. Airport way -- Arch Airport Road/Sperry Road  
**CITY/STATE:** San Joaquin, CA

**QC JOB #:** 14437936  
**DATE:** Thu, Jun 01 2017

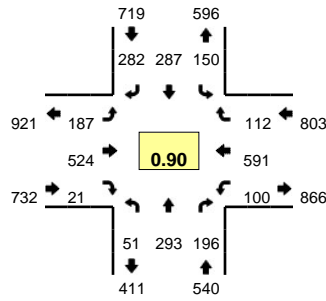

**Peak-Hour: 4:00 PM -- 5:00 PM**  
**Peak 15-Min: 4:35 PM -- 4:50 PM**

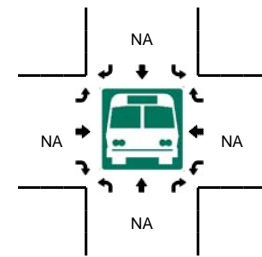
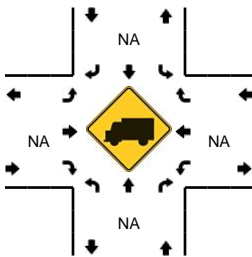
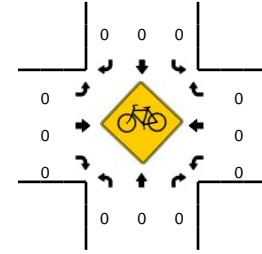
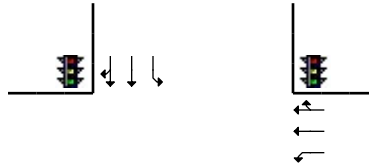
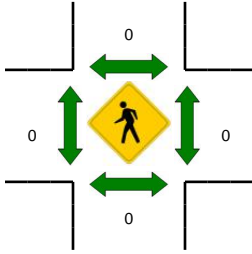
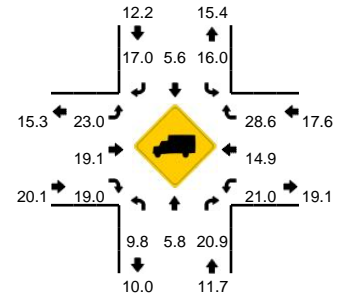

| 5-Min Count Period Beginning At | 18. Airport way (Northbound) |      |       |   | 18. Airport way (Southbound) |      |       |   | Arch Airport Road/Sperry Road (Eastbound) |      |       |   | Arch Airport Road/Sperry Road (Westbound) |      |       |   | Total | Hourly Totals |
|---------------------------------|------------------------------|------|-------|---|------------------------------|------|-------|---|---|------|-------|---|---|------|-------|---|-------|---------------|
|                                 | Left                         | Thru | Right | U | Left                         | Thru | Right | U | Left                                      | Thru | Right | U | Left                                      | Thru | Right | U |       |               |
| 4:00 PM                         | 5                            | 26   | 17    | 0 | 9                            | 18   | 29    | 0 | 13  | 31   | 3     | 0 | 8   | 39   | 16    | 0 | 214   |               |
| 4:05 PM                         | 5                            | 19   | 16    | 0 | 13                           | 29   | 25    | 1 | 18  | 67   | 2     | 0 | 8   | 54   | 10    | 0 | 267   |               |
| 4:10 PM                         | 8                            | 25   | 25    | 0 | 19                           | 18   | 32    | 0 | 14  | 41   | 2     | 0 | 6   | 45   | 10    | 0 | 245   |               |
| 4:15 PM                         | 1                            | 31   | 26    | 0 | 12                           | 22   | 18    | 0 | 20  | 42   | 1     | 0 | 6   | 35   | 6     | 0 | 220   |               |
| 4:20 PM                         | 7                            | 31   | 14    | 1 | 9                            | 23   | 23    | 0 | 4   | 41   | 3     | 0 | 4   | 55   | 7     | 0 | 222   |               |
| 4:25 PM                         | 5                            | 19   | 13    | 0 | 9                            | 26   | 26    | 0 | 14  | 41   | 2     | 0 | 8   | 41   | 5     | 0 | 209   |               |
| 4:30 PM                         | 3                            | 21   | 7     | 0 | 15                           | 22   | 24    | 0 | 19  | 45   | 1     | 0 | 16  | 44   | 12    | 0 | 229   |               |
| 4:35 PM                         | 5                            | 37   | 19    | 0 | 20                           | 19   | 24    | 1 | 16  | 42   | 1     | 0 | 9   | 68   | 9     | 0 | 270   |               |
| 4:40 PM                         | 3                            | 14   | 13    | 0 | 12                           | 31   | 26    | 0 | 15  | 44   | 2     | 0 | 8   | 77   | 11    | 0 | 256   |               |
| 4:45 PM                         | 5                            | 24   | 23    | 2 | 18                           | 42   | 26    | 0 | 9   | 30   | 1     | 0 | 12  | 50   | 11    | 0 | 253   |               |
| 4:50 PM                         | 1                            | 21   | 12    | 0 | 3                            | 16   | 17    | 0 | 21  | 61   | 2     | 0 | 7   | 47   | 7     | 0 | 215   |               |
| 4:55 PM                         | 0                            | 25   | 11    | 0 | 7                            | 21   | 12    | 2 | 24  | 39   | 1     | 0 | 8   | 36   | 8     | 0 | 194   | 2794          |
| 5:00 PM                         | 2                            | 22   | 14    | 0 | 12                           | 18   | 18    | 1 | 12  | 48   | 0     | 0 | 1   | 41   | 5     | 0 | 194   | 2774          |
| 5:05 PM                         | 2                            | 29   | 13    | 0 | 7                            | 32   | 19    | 1 | 21  | 37   | 3     | 0 | 19  | 68   | 6     | 0 | 257   | 2764          |
| 5:10 PM                         | 4                            | 22   | 9     | 0 | 6                            | 16   | 18    | 0 | 14  | 60   | 2     | 0 | 5   | 64   | 5     | 0 | 225   | 2744          |
| 5:15 PM                         | 8                            | 26   | 17    | 0 | 19                           | 29   | 24    | 0 | 18  | 42   | 3     | 0 | 4   | 27   | 4     | 0 | 221   | 2745          |
| 5:20 PM                         | 6                            | 16   | 11    | 1 | 8                            | 14   | 24    | 0 | 11  | 39   | 2     | 0 | 11  | 35   | 7     | 0 | 185   | 2708          |
| 5:25 PM                         | 5                            | 12   | 13    | 0 | 6                            | 19   | 10    | 0 | 16  | 45   | 2     | 0 | 9   | 47   | 9     | 0 | 193   | 2692          |
| 5:30 PM                         | 2                            | 18   | 6     | 0 | 13                           | 20   | 25    | 0 | 8   | 37   | 0     | 0 | 10  | 39   | 6     | 0 | 184   | 2647          |
| 5:35 PM                         | 2                            | 15   | 9     | 0 | 17                           | 17   | 18    | 0 | 11  | 28   | 2     | 0 | 7   | 51   | 6     | 0 | 183   | 2560          |
| 5:40 PM                         | 1                            | 13   | 11    | 0 | 6                            | 21   | 13    | 0 | 9   | 46   | 2     | 0 | 7   | 36   | 3     | 0 | 168   | 2472          |
| 5:45 PM                         | 4                            | 16   | 14    | 0 | 9                            | 16   | 14    | 0 | 9   | 35   | 0     | 0 | 9   | 34   | 4     | 0 | 164   | 2383          |
| 5:50 PM                         | 0                            | 17   | 10    | 0 | 9                            | 12   | 11    | 0 | 22  | 35   | 1     | 0 | 9   | 17   | 8     | 0 | 151   | 2319          |
| 5:55 PM                         | 2                            | 22   | 11    | 1 | 7                            | 10   | 9     | 0 | 9   | 34   | 1     | 0 | 3   | 31   | 5     | 0 | 145   | 2270          |
| Peak 15-Min Flowrates           | Northbound                   |      |       |   | Southbound                   |      |       |   | Eastbound                                 |      |       |   | Westbound                                 |      |       |   | Total |               |
|                                 | Left                         | Thru | Right | U | Left                         | Thru | Right | U | Left                                      | Thru | Right | U | Left                                      | Thru | Right | U |       |               |
| All Vehicles                    | 52                           | 300  | 220   | 8 | 200                          | 368  | 304   | 4 | 160                                       | 464  | 16    | 0 | 116                                       | 780  | 124   | 0 | 3116  |               |
| Heavy Trucks                    | 4                            | 24   | 36    |   | 28                           | 8    | 48    |   | 32  | 80   | 8     |   | 28  | 108  | 24    |   | 428   |               |
| Pedestrians                     |                              | 0    |       |   |                              | 0    |       |   |   | 0    |       |   |   | 0    |       |   | 0     |               |
| Bicycles                        | 0                            | 0    | 0     |   | 0                            | 0    | 0     |   | 0   | 0    | 0     |   | 0   | 0    | 0     |   | 0     |               |
| Railroad                        |                              |      |       |   |                              |      |       |   |   |      |       |   |   |      |       |   |       |               |
| Stopped Buses                   |                              |      |       |   |                              |      |       |   |   |      |       |   |   |      |       |   |       |               |

Comments:

**LOCATION:** 19. Newcastle Rd -- Arch Rd  
**CITY/STATE:** San Joaquin, CA

**QC JOB #:** 14437937  
**DATE:** Thu, Jun 01 2017

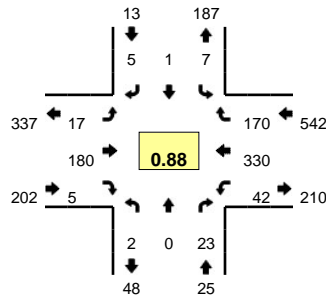

**Peak-Hour: 7:05 AM -- 8:05 AM**  
**Peak 15-Min: 7:35 AM -- 7:50 AM**

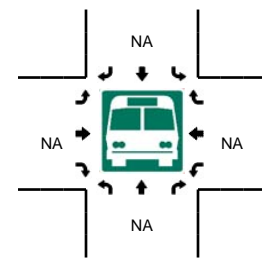
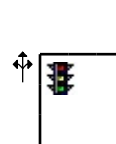
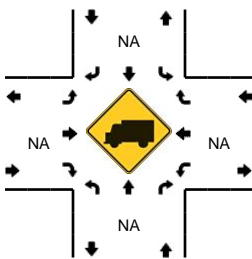
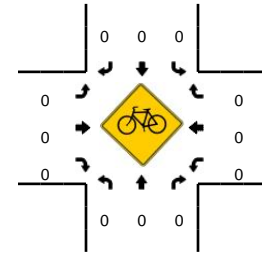
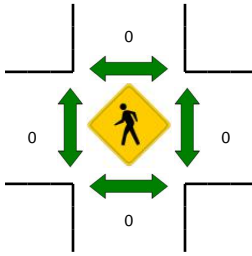
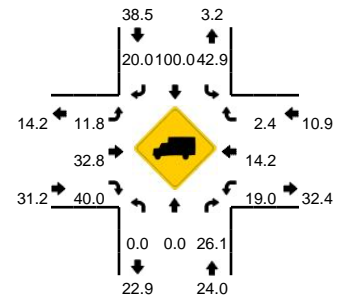

| 5-Min Count Period Beginning At | 19. Newcastle Rd (Northbound) |      |       |   | 19. Newcastle Rd (Southbound) |      |       |   | Arch Rd (Eastbound) |      |       |   | Arch Rd (Westbound) |      |       |   | Total | Hourly Totals |
|---------------------------------|-------------------------------|------|-------|---|-------------------------------|------|-------|---|---------------------|------|-------|---|---------------------|------|-------|---|-------|---------------|
|                                 | Left                          | Thru | Right | U | Left                          | Thru | Right | U | Left                | Thru | Right | U | Left                | Thru | Right | U |       |               |
| 7:00 AM                         | 1                             | 0    | 0     | 0 | 0                             | 0    | 0     | 0 | 0                   | 3    | 0     | 0 | 1                   | 7    | 3     | 0 | 15    |               |
| 7:05 AM                         | 1                             | 0    | 2     | 0 | 0                             | 0    | 0     | 0 | 1                   | 17   | 1     | 0 | 3                   | 33   | 9     | 0 | 67    |               |
| 7:10 AM                         | 0                             | 0    | 2     | 0 | 1                             | 0    | 0     | 0 | 0                   | 16   | 0     | 0 | 4                   | 28   | 8     | 0 | 59    |               |
| 7:15 AM                         | 0                             | 0    | 3     | 0 | 0                             | 0    | 0     | 0 | 0                   | 17   | 1     | 0 | 4                   | 24   | 14    | 0 | 63    |               |
| 7:20 AM                         | 0                             | 0    | 1     | 0 | 1                             | 0    | 0     | 0 | 4                   | 20   | 1     | 0 | 2                   | 17   | 14    | 0 | 60    |               |
| 7:25 AM                         | 0                             | 0    | 3     | 0 | 1                             | 0    | 1     | 0 | 3                   | 8    | 0     | 0 | 5                   | 36   | 16    | 0 | 73    |               |
| 7:30 AM                         | 0                             | 0    | 4     | 0 | 1                             | 0    | 0     | 0 | 2                   | 15   | 0     | 0 | 1                   | 12   | 13    | 0 | 48    |               |
| 7:35 AM                         | 0                             | 0    | 2     | 0 | 1                             | 0    | 0     | 0 | 1                   | 14   | 0     | 0 | 4                   | 32   | 17    | 0 | 71    |               |
| 7:40 AM                         | 0                             | 0    | 2     | 0 | 0                             | 0    | 2     | 0 | 0                   | 14   | 1     | 0 | 3                   | 32   | 20    | 0 | 74    |               |
| 7:45 AM                         | 0                             | 0    | 2     | 0 | 0                             | 0    | 1     | 0 | 1                   | 15   | 0     | 0 | 5                   | 32   | 22    | 0 | 78    |               |
| 7:50 AM                         | 0                             | 0    | 0     | 0 | 1                             | 1    | 0     | 0 | 2                   | 18   | 0     | 0 | 5                   | 25   | 10    | 0 | 62    |               |
| 7:55 AM                         | 0                             | 0    | 2     | 0 | 1                             | 0    | 0     | 0 | 3                   | 12   | 1     | 0 | 2                   | 31   | 17    | 0 | 69    | 739           |
| 8:00 AM                         | 1                             | 0    | 0     | 0 | 0                             | 0    | 1     | 0 | 0                   | 14   | 0     | 0 | 4                   | 28   | 10    | 0 | 58    | 782           |
| 8:05 AM                         | 0                             | 1    | 3     | 0 | 2                             | 0    | 0     | 0 | 0                   | 9    | 0     | 0 | 0                   | 13   | 5     | 0 | 33    | 748           |
| 8:10 AM                         | 0                             | 0    | 3     | 0 | 1                             | 1    | 0     | 0 | 2                   | 12   | 0     | 0 | 3                   | 22   | 8     | 0 | 52    | 741           |
| 8:15 AM                         | 0                             | 0    | 4     | 0 | 5                             | 0    | 1     | 0 | 1                   | 13   | 0     | 0 | 5                   | 19   | 6     | 0 | 54    | 732           |
| 8:20 AM                         | 0                             | 0    | 2     | 0 | 2                             | 0    | 0     | 0 | 0                   | 7    | 0     | 0 | 0                   | 9    | 7     | 0 | 27    | 699           |
| 8:25 AM                         | 0                             | 0    | 1     | 0 | 3                             | 0    | 1     | 1 | 0                   | 7    | 2     | 0 | 2                   | 13   | 5     | 0 | 35    | 661           |
| 8:30 AM                         | 0                             | 0    | 4     | 0 | 1                             | 0    | 0     | 0 | 1                   | 7    | 0     | 0 | 2                   | 10   | 7     | 0 | 32    | 645           |
| 8:35 AM                         | 0                             | 0    | 1     | 0 | 1                             | 1    | 0     | 0 | 1                   | 13   | 1     | 0 | 7                   | 7    | 3     | 0 | 35    | 609           |
| 8:40 AM                         | 0                             | 0    | 1     | 0 | 2                             | 0    | 1     | 0 | 0                   | 6    | 0     | 0 | 5                   | 9    | 6     | 0 | 30    | 565           |
| 8:45 AM                         | 0                             | 0    | 2     | 0 | 2                             | 0    | 3     | 0 | 0                   | 13   | 0     | 0 | 6                   | 13   | 1     | 0 | 40    | 527           |
| 8:50 AM                         | 0                             | 0    | 8     | 0 | 0                             | 0    | 1     | 0 | 0                   | 9    | 0     | 0 | 12                  | 11   | 8     | 0 | 49    | 514           |
| 8:55 AM                         | 0                             | 0    | 4     | 0 | 2                             | 0    | 0     | 0 | 0                   | 5    | 0     | 0 | 11                  | 8    | 5     | 0 | 35    | 480           |
| Peak 15-Min Flowrates           | Northbound                    |      |       |   | Southbound                    |      |       |   | Eastbound           |      |       |   | Westbound           |      |       |   | Total |               |
|                                 | Left                          | Thru | Right | U | Left                          | Thru | Right | U | Left                | Thru | Right | U | Left                | Thru | Right | U |       |               |
| All Vehicles                    | 0                             | 0    | 24    | 0 | 4                             | 0    | 12    | 0 | 8                   | 172  | 4     | 0 | 48                  | 384  | 236   | 0 | 892   |               |
| Heavy Trucks                    | 0                             | 0    | 8     |   | 4                             | 0    | 0     |   | 0                   | 52   | 0     |   | 12                  | 56   | 4     |   | 136   |               |
| Pedestrians                     |                               |      |       |   |                               |      |       |   |                     | 0    |       |   |                     | 0    |       |   | 0     |               |
| Bicycles                        |                               |      |       |   |                               |      |       |   |                     | 0    | 0     | 0 |                     | 0    | 0     | 0 | 0     |               |
| Railroad                        |                               |      |       |   |                               |      |       |   |                     |      |       |   |                     |      |       |   |       |               |
| Stopped Buses                   |                               |      |       |   |                               |      |       |   |                     |      |       |   |                     |      |       |   |       |               |

Comments:

**LOCATION:** 19. Newcastle Rd -- Arch Rd  
**CITY/STATE:** San Joaquin, CA

**QC JOB #:** 14437938  
**DATE:** Thu, Jun 01 2017

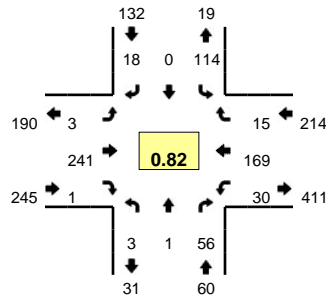

**Peak-Hour: 4:00 PM -- 5:00 PM**  
**Peak 15-Min: 4:00 PM -- 4:15 PM**

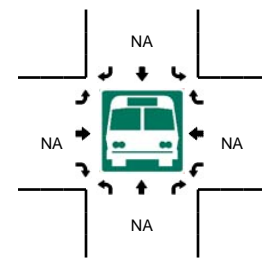
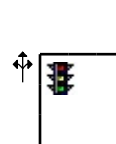
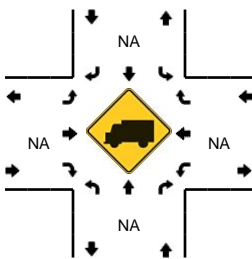
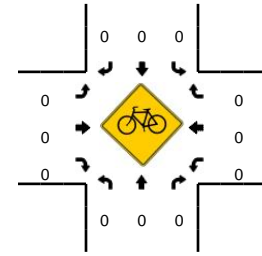
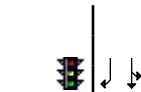
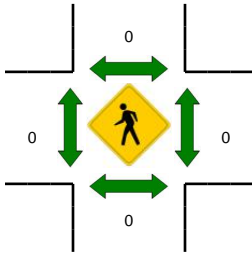
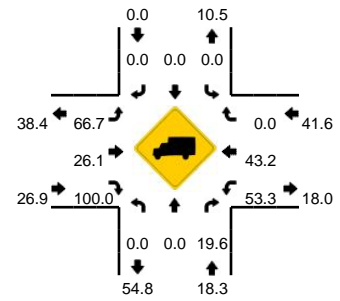

| 5-Min Count Period<br>Beginning At | 19. Newcastle Rd (Northbound) |      |       |   | 19. Newcastle Rd (Southbound) |      |       |   | Arch Rd (Eastbound) |      |       |   | Arch Rd (Westbound) |      |       |   | Total | Hourly Totals |
|------------------------------------|-------------------------------|------|-------|---|-------------------------------|------|-------|---|---------------------|------|-------|---|---------------------|------|-------|---|-------|---------------|
|                                    | Left                          | Thru | Right | U | Left                          | Thru | Right | U | Left                | Thru | Right | U | Left                | Thru | Right | U |       |               |
| 4:00 PM                            | 1                             | 0    | 5     | 0 | 15                            | 0    | 4     | 0 | 0                   | 25   | 0     | 0 | 1                   | 13   | 1     | 0 | 65    |               |
| 4:05 PM                            | 1                             | 1    | 3     | 0 | 29                            | 0    | 4     | 0 | 0                   | 18   | 0     | 0 | 1                   | 16   | 0     | 0 | 73    |               |
| 4:10 PM                            | 0                             | 0    | 6     | 0 | 8                             | 0    | 1     | 0 | 0                   | 31   | 0     | 0 | 1                   | 12   | 2     | 0 | 61    |               |
| 4:15 PM                            | 0                             | 0    | 2     | 0 | 8                             | 0    | 1     | 0 | 0                   | 20   | 1     | 0 | 5                   | 14   | 2     | 0 | 53    |               |
| 4:20 PM                            | 0                             | 0    | 0     | 0 | 7                             | 0    | 1     | 0 | 0                   | 17   | 0     | 0 | 4                   | 17   | 2     | 0 | 48    |               |
| 4:25 PM                            | 0                             | 0    | 5     | 0 | 10                            | 0    | 0     | 0 | 1                   | 26   | 0     | 0 | 4                   | 13   | 2     | 0 | 61    |               |
| 4:30 PM                            | 0                             | 0    | 5     | 0 | 5                             | 0    | 1     | 0 | 0                   | 26   | 0     | 0 | 3                   | 17   | 1     | 0 | 58    |               |
| 4:35 PM                            | 0                             | 0    | 7     | 0 | 10                            | 0    | 1     | 0 | 0                   | 22   | 0     | 0 | 2                   | 9    | 0     | 0 | 51    |               |
| 4:40 PM                            | 0                             | 0    | 8     | 0 | 6                             | 0    | 4     | 0 | 0                   | 20   | 0     | 0 | 1                   | 15   | 3     | 0 | 57    |               |
| 4:45 PM                            | 1                             | 0    | 4     | 0 | 2                             | 0    | 1     | 0 | 2                   | 14   | 0     | 0 | 3                   | 17   | 1     | 0 | 45    |               |
| 4:50 PM                            | 0                             | 0    | 2     | 0 | 8                             | 0    | 0     | 0 | 0                   | 9    | 0     | 0 | 2                   | 13   | 0     | 0 | 34    |               |
| 4:55 PM                            | 0                             | 0    | 9     | 0 | 6                             | 0    | 0     | 0 | 0                   | 13   | 0     | 0 | 3                   | 13   | 1     | 0 | 45    | 651           |
| 5:00 PM                            | 0                             | 1    | 6     | 0 | 10                            | 0    | 1     | 0 | 1                   | 13   | 0     | 0 | 1                   | 7    | 1     | 0 | 41    | 627           |
| 5:05 PM                            | 1                             | 0    | 7     | 0 | 10                            | 0    | 1     | 0 | 0                   | 31   | 0     | 0 | 3                   | 19   | 1     | 0 | 73    | 627           |
| 5:10 PM                            | 0                             | 0    | 3     | 0 | 4                             | 0    | 0     | 0 | 0                   | 26   | 0     | 0 | 1                   | 16   | 0     | 0 | 50    | 616           |
| 5:15 PM                            | 0                             | 0    | 2     | 0 | 0                             | 0    | 1     | 0 | 0                   | 17   | 0     | 0 | 1                   | 10   | 0     | 0 | 31    | 594           |
| 5:20 PM                            | 3                             | 0    | 8     | 0 | 6                             | 0    | 1     | 0 | 1                   | 12   | 1     | 0 | 2                   | 17   | 1     | 0 | 52    | 598           |
| 5:25 PM                            | 0                             | 0    | 3     | 0 | 6                             | 0    | 0     | 0 | 2                   | 10   | 1     | 0 | 2                   | 14   | 0     | 0 | 38    | 575           |
| 5:30 PM                            | 1                             | 0    | 4     | 0 | 2                             | 0    | 0     | 0 | 0                   | 16   | 0     | 0 | 0                   | 12   | 2     | 0 | 37    | 554           |
| 5:35 PM                            | 1                             | 0    | 0     | 0 | 4                             | 0    | 1     | 0 | 0                   | 16   | 0     | 0 | 1                   | 11   | 2     | 0 | 36    | 539           |
| 5:40 PM                            | 0                             | 0    | 3     | 0 | 1                             | 0    | 0     | 0 | 0                   | 13   | 0     | 0 | 1                   | 11   | 1     | 0 | 30    | 512           |
| 5:45 PM                            | 0                             | 0    | 0     | 0 | 3                             | 0    | 0     | 0 | 0                   | 8    | 1     | 0 | 0                   | 8    | 1     | 0 | 21    | 488           |
| 5:50 PM                            | 0                             | 0    | 2     | 0 | 2                             | 0    | 0     | 0 | 0                   | 15   | 0     | 0 | 3                   | 8    | 0     | 0 | 30    | 484           |
| 5:55 PM                            | 0                             | 0    | 2     | 0 | 1                             | 0    | 0     | 0 | 0                   | 9    | 0     | 0 | 3                   | 14   | 0     | 0 | 29    | 468           |
| Peak 15-Min Flowrates              | Northbound                    |      |       |   | Southbound                    |      |       |   | Eastbound           |      |       |   | Westbound           |      |       |   | Total |               |
|                                    | Left                          | Thru | Right | U | Left                          | Thru | Right | U | Left                | Thru | Right | U | Left                | Thru | Right | U |       |               |
| All Vehicles                       | 8                             | 4    | 56    | 0 | 208                           | 0    | 36    | 0 | 0                   | 296  | 0     | 0 | 12                  | 164  | 12    | 0 | 796   |               |
| Heavy Trucks                       | 0                             | 0    | 8     |   | 0                             | 0    | 0     |   | 0                   | 64   | 0     |   | 8                   | 76   | 0     |   | 156   |               |
| Pedestrians                        | 0                             |      |       |   | 0                             |      |       |   | 0                   | 0    |       |   | 0                   | 0    |       |   | 0     |               |
| Bicycles                           | 0                             | 0    | 0     |   | 0                             | 0    | 0     |   | 0                   | 0    | 0     |   | 0                   | 0    | 0     |   | 0     |               |
| Railroad                           |                               |      |       |   |                               |      |       |   |                     |      |       |   |                     |      |       |   |       |               |
| Stopped Buses                      |                               |      |       |   |                               |      |       |   |                     |      |       |   |                     |      |       |   |       |               |

Comments:



**LOCATION:** 20. French Camp Rd -- French Camp Rd  
**CITY/STATE:** Manteca, CA

**QC JOB #:** 14437939  
**DATE:** Thu, Jun 01 2017

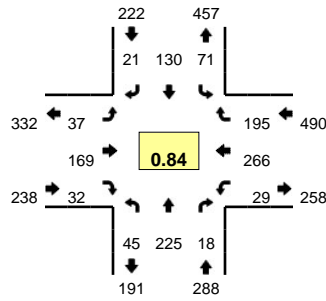

**Peak-Hour: 7:20 AM -- 8:20 AM**  
**Peak 15-Min: 7:40 AM -- 7:55 AM**

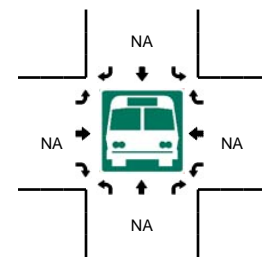
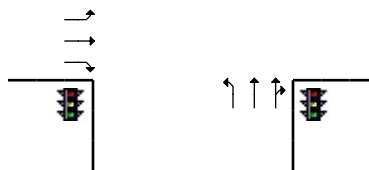
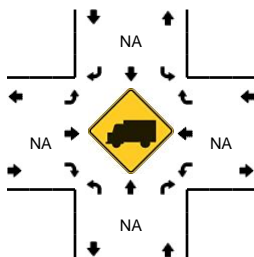
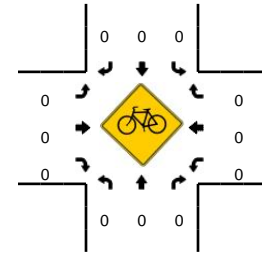
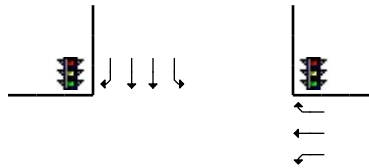
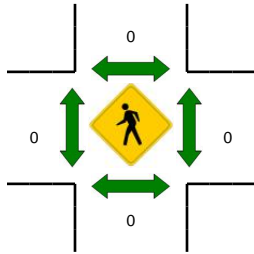
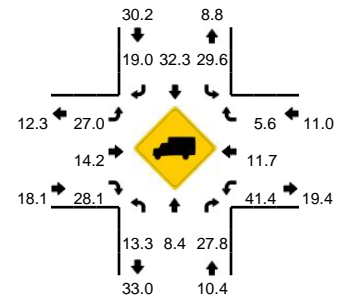

| 5-Min Count Period Beginning At | 20. French Camp Rd (Northbound) |      |       |   | 20. French Camp Rd (Southbound) |      |       |   | French Camp Rd (Eastbound) |      |       |   | French Camp Rd (Westbound) |      |       |   | Total | Hourly Totals |
|---------------------------------|---------------------------------|------|-------|---|---------------------------------|------|-------|---|----------------------------|------|-------|---|----------------------------|------|-------|---|-------|---------------|
|                                 | Left                            | Thru | Right | U | Left                            | Thru | Right | U | Left                       | Thru | Right | U | Left                       | Thru | Right | U |       |               |
| 7:00 AM                         | 0                               | 0    | 0     | 0 | 0                               | 0    | 0     | 0 | 0                          | 0    | 0     | 0 | 0                          | 0    | 0     | 0 | 0     |               |
| 7:05 AM                         | 0                               | 0    | 0     | 0 | 0                               | 0    | 0     | 0 | 0                          | 0    | 0     | 0 | 0                          | 0    | 0     | 0 | 0     |               |
| 7:10 AM                         | 0                               | 0    | 0     | 0 | 0                               | 0    | 0     | 0 | 0                          | 0    | 0     | 0 | 0                          | 0    | 0     | 0 | 0     |               |
| 7:15 AM                         | 1                               | 10   | 1     | 0 | 2                               | 3    | 1     | 0 | 0                          | 2    | 3     | 0 | 1                          | 14   | 6     | 0 | 44    |               |
| 7:20 AM                         | 4                               | 15   | 1     | 0 | 4                               | 10   | 3     | 0 | 1                          | 12   | 3     | 0 | 2                          | 26   | 16    | 0 | 97    |               |
| 7:25 AM                         | 3                               | 19   | 1     | 0 | 7                               | 8    | 0     | 0 | 4                          | 15   | 6     | 0 | 3                          | 18   | 12    | 0 | 96    |               |
| 7:30 AM                         | 4                               | 16   | 2     | 0 | 6                               | 19   | 1     | 0 | 4                          | 16   | 0     | 0 | 2                          | 15   | 15    | 0 | 100   |               |
| 7:35 AM                         | 5                               | 12   | 2     | 0 | 8                               | 6    | 0     | 0 | 3                          | 17   | 2     | 0 | 5                          | 25   | 7     | 0 | 92    |               |
| 7:40 AM                         | 7                               | 32   | 2     | 0 | 6                               | 13   | 1     | 0 | 4                          | 14   | 6     | 0 | 0                          | 24   | 28    | 0 | 137   |               |
| 7:45 AM                         | 2                               | 27   | 1     | 0 | 5                               | 8    | 1     | 0 | 3                          | 17   | 0     | 0 | 3                          | 27   | 27    | 0 | 121   |               |
| 7:50 AM                         | 2                               | 19   | 0     | 0 | 6                               | 9    | 3     | 0 | 3                          | 14   | 5     | 0 | 2                          | 30   | 19    | 0 | 112   |               |
| 7:55 AM                         | 3                               | 17   | 4     | 0 | 6                               | 7    | 2     | 0 | 3                          | 11   | 2     | 0 | 1                          | 21   | 19    | 0 | 96    |               |
| 8:00 AM                         | 4                               | 17   | 1     | 0 | 5                               | 9    | 4     | 0 | 2                          | 12   | 0     | 0 | 4                          | 22   | 17    | 0 | 97    |               |
| 8:05 AM                         | 4                               | 13   | 0     | 0 | 13                              | 17   | 3     | 0 | 5                          | 18   | 2     | 0 | 3                          | 16   | 10    | 0 | 104   |               |
| 8:10 AM                         | 4                               | 23   | 4     | 0 | 1                               | 9    | 1     | 0 | 1                          | 14   | 3     | 0 | 2                          | 22   | 18    | 0 | 102   |               |
| 8:15 AM                         | 3                               | 15   | 0     | 0 | 4                               | 15   | 2     | 0 | 4                          | 9    | 3     | 0 | 2                          | 20   | 7     | 0 | 84    |               |
| 8:20 AM                         | 0                               | 18   | 3     | 0 | 7                               | 8    | 5     | 0 | 4                          | 20   | 4     | 0 | 2                          | 13   | 13    | 0 | 97    |               |
| 8:25 AM                         | 1                               | 15   | 2     | 0 | 4                               | 8    | 3     | 0 | 3                          | 14   | 1     | 0 | 2                          | 9    | 12    | 0 | 74    |               |
| 8:30 AM                         | 2                               | 9    | 1     | 0 | 6                               | 13   | 2     | 0 | 3                          | 14   | 1     | 0 | 2                          | 10   | 14    | 0 | 77    |               |
| 8:35 AM                         | 3                               | 13   | 0     | 0 | 5                               | 9    | 1     | 0 | 2                          | 9    | 4     | 0 | 2                          | 19   | 10    | 0 | 77    |               |
| 8:40 AM                         | 8                               | 10   | 0     | 0 | 2                               | 4    | 3     | 0 | 2                          | 15   | 4     | 0 | 2                          | 17   | 10    | 0 | 77    |               |
| 8:45 AM                         | 3                               | 17   | 0     | 0 | 5                               | 10   | 4     | 0 | 4                          | 20   | 1     | 0 | 1                          | 21   | 8     | 0 | 94    |               |
| 8:50 AM                         | 2                               | 3    | 0     | 0 | 4                               | 12   | 2     | 0 | 5                          | 19   | 2     | 0 | 0                          | 17   | 12    | 0 | 78    |               |
| 8:55 AM                         | 4                               | 12   | 2     | 0 | 2                               | 10   | 0     | 0 | 4                          | 15   | 4     | 0 | 2                          | 11   | 14    | 0 | 80    |               |
| Peak 15-Min Flowrates           | Northbound                      |      |       |   | Southbound                      |      |       |   | Eastbound                  |      |       |   | Westbound                  |      |       |   | Total |               |
|                                 | Left                            | Thru | Right | U | Left                            | Thru | Right | U | Left                       | Thru | Right | U | Left                       | Thru | Right | U |       |               |
| All Vehicles                    | 44                              | 312  | 12    | 0 | 68                              | 120  | 20    | 0 | 40                         | 180  | 44    | 0 | 20                         | 324  | 296   | 0 | 1480  |               |
| Heavy Trucks                    | 4                               | 28   | 4     |   | 32                              | 44   | 0     |   | 20                         | 36   | 12    |   | 16                         | 16   | 16    |   | 228   |               |
| Pedestrians                     |                                 | 0    |       |   |                                 | 0    |       |   |                            | 0    |       |   |                            | 0    |       |   | 0     |               |
| Bicycles                        | 0                               | 0    | 0     |   | 0                               | 0    | 0     |   | 0                          | 0    | 0     |   | 0                          | 0    | 0     |   | 0     |               |
| Railroad                        |                                 |      |       |   |                                 |      |       |   |                            |      |       |   |                            |      |       |   |       |               |
| Stopped Buses                   |                                 |      |       |   |                                 |      |       |   |                            |      |       |   |                            |      |       |   |       |               |

Comments:

**LOCATION:** 20. French Camp Rd -- French Camp Rd  
**CITY/STATE:** Manteca, CA

**QC JOB #:** 14437940  
**DATE:** Thu, Jun 01 2017

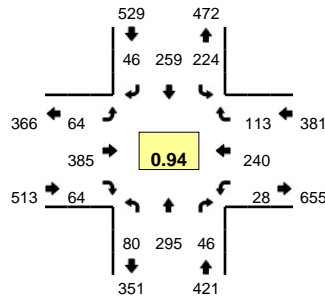



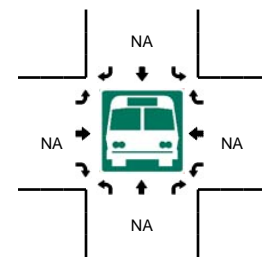
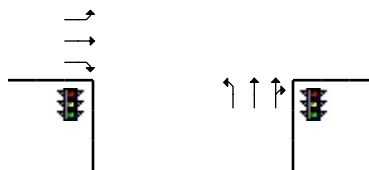
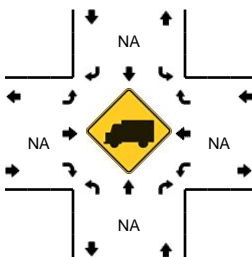
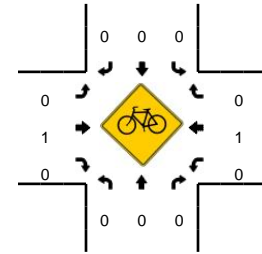
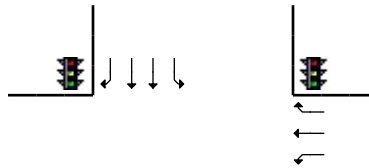
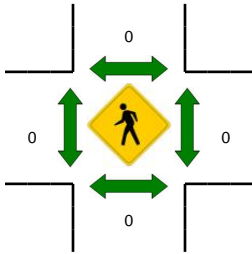
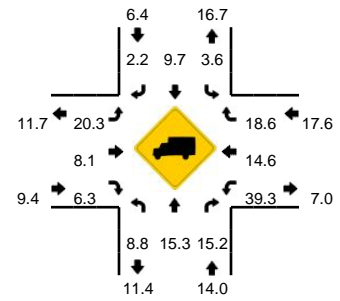







**Peak-Hour: 4:00 PM -- 5:00 PM**  
**Peak 15-Min: 4:05 PM -- 4:20 PM**



| 5-Min Count Period Beginning At | 20. French Camp Rd (Northbound) |      |       |   | 20. French Camp Rd (Southbound) |      |       |   | French Camp Rd (Eastbound) |      |       |   | French Camp Rd (Westbound) |      |       |   | Total | Hourly Totals |
|---------------------------------|---------------------------------|------|-------|---|---------------------------------|------|-------|---|----------------------------|------|-------|---|----------------------------|------|-------|---|-------|---------------|
|                                 | Left                            | Thru | Right | U | Left                            | Thru | Right | U | Left                       | Thru | Right | U | Left                       | Thru | Right | U |       |               |
| 4:00 PM                         | 4                               | 18   | 2     | 0 | 23                              | 26   | 7     | 0 | 8                          | 30   | 6     | 0 | 3                          | 12   | 11    | 0 | 150   |               |
| 4:05 PM                         | 9                               | 30   | 2     | 0 | 17                              | 20   | 8     | 0 | 7                          | 37   | 11    | 0 | 2                          | 14   | 8     | 0 | 165   |               |
| 4:10 PM                         | 4                               | 36   | 7     | 0 | 21                              | 26   | 1     | 0 | 7                          | 28   | 4     | 0 | 3                          | 20   | 8     | 0 | 165   |               |
| 4:15 PM                         | 10                              | 33   | 6     | 0 | 22                              | 12   | 1     | 0 | 6                          | 26   | 9     | 0 | 6                          | 20   | 12    | 0 | 163   |               |
| 4:20 PM                         | 3                               | 18   | 3     | 0 | 7                               | 20   | 6     | 0 | 5                          | 44   | 13    | 0 | 0                          | 25   | 10    | 0 | 154   |               |
| 4:25 PM                         | 8                               | 20   | 5     | 0 | 19                              | 13   | 2     | 0 | 3                          | 22   | 1     | 0 | 2                          | 28   | 8     | 0 | 131   |               |
| 4:30 PM                         | 6                               | 33   | 7     | 0 | 17                              | 29   | 4     | 0 | 2                          | 29   | 3     | 0 | 1                          | 14   | 14    | 0 | 159   |               |
| 4:35 PM                         | 6                               | 21   | 2     | 0 | 21                              | 16   | 2     | 0 | 7                          | 35   | 6     | 0 | 2                          | 19   | 4     | 0 | 141   |               |
| 4:40 PM                         | 8                               | 21   | 4     | 0 | 25                              | 26   | 4     | 0 | 9                          | 29   | 4     | 0 | 2                          | 30   | 12    | 0 | 174   |               |
| 4:45 PM                         | 8                               | 23   | 5     | 0 | 23                              | 26   | 6     | 0 | 2                          | 34   | 3     | 0 | 5                          | 21   | 12    | 0 | 168   |               |
| 4:50 PM                         | 7                               | 25   | 0     | 0 | 21                              | 28   | 3     | 0 | 3                          | 35   | 3     | 0 | 2                          | 18   | 6     | 0 | 151   |               |
| 4:55 PM                         | 7                               | 17   | 3     | 0 | 8                               | 17   | 2     | 0 | 5                          | 36   | 1     | 0 | 0                          | 19   | 8     | 0 | 123   | 1844          |
| 5:00 PM                         | 4                               | 20   | 3     | 0 | 16                              | 17   | 4     | 0 | 4                          | 33   | 3     | 0 | 1                          | 22   | 9     | 0 | 136   | 1830          |
| 5:05 PM                         | 3                               | 23   | 1     | 0 | 8                               | 17   | 2     | 0 | 2                          | 24   | 6     | 0 | 1                          | 19   | 7     | 0 | 113   | 1778          |
| 5:10 PM                         | 10                              | 22   | 2     | 0 | 30                              | 32   | 7     | 0 | 5                          | 34   | 10    | 0 | 1                          | 13   | 9     | 0 | 175   | 1788          |
| 5:15 PM                         | 8                               | 18   | 3     | 0 | 19                              | 23   | 2     | 0 | 6                          | 52   | 4     | 0 | 0                          | 21   | 9     | 0 | 165   | 1790          |
| 5:20 PM                         | 13                              | 12   | 2     | 0 | 15                              | 19   | 0     | 0 | 10                         | 36   | 9     | 0 | 1                          | 14   | 7     | 0 | 138   | 1774          |
| 5:25 PM                         | 5                               | 14   | 0     | 0 | 13                              | 22   | 1     | 0 | 2                          | 29   | 3     | 0 | 1                          | 15   | 11    | 0 | 116   | 1759          |
| 5:30 PM                         | 14                              | 14   | 3     | 0 | 4                               | 22   | 2     | 0 | 1                          | 34   | 1     | 0 | 2                          | 23   | 9     | 0 | 129   | 1729          |
| 5:35 PM                         | 7                               | 9    | 6     | 0 | 22                              | 16   | 1     | 0 | 3                          | 31   | 4     | 0 | 2                          | 13   | 6     | 0 | 120   | 1708          |
| 5:40 PM                         | 6                               | 26   | 11    | 0 | 9                               | 24   | 2     | 0 | 4                          | 11   | 1     | 0 | 2                          | 22   | 6     | 0 | 124   | 1658          |
| 5:45 PM                         | 5                               | 14   | 0     | 0 | 13                              | 18   | 4     | 0 | 4                          | 38   | 8     | 0 | 2                          | 15   | 6     | 0 | 127   | 1617          |
| 5:50 PM                         | 3                               | 16   | 1     | 0 | 8                               | 14   | 2     | 0 | 8                          | 29   | 4     | 0 | 0                          | 28   | 9     | 0 | 122   | 1588          |
| 5:55 PM                         | 3                               | 10   | 4     | 0 | 11                              | 12   | 3     | 0 | 1                          | 31   | 4     | 0 | 2                          | 22   | 7     | 0 | 110   | 1575          |
| Peak 15-Min Flowrates           | Northbound                      |      |       |   | Southbound                      |      |       |   | Eastbound                  |      |       |   | Westbound                  |      |       |   | Total |               |
|                                 | Left                            | Thru | Right | U | Left                            | Thru | Right | U | Left                       | Thru | Right | U | Left                       | Thru | Right | U |       |               |
| All Vehicles                    | 92                              | 396  | 60    | 0 | 240                             | 232  | 40    | 0 | 80                         | 364  | 96    | 0 | 44                         | 216  | 112   | 0 | 1972  |               |
| Heavy Trucks                    | 12                              | 56   | 12    |   | 8                               | 8    | 4     |   | 16                         | 32   | 4     |   | 32                         | 40   | 24    |   | 248   |               |
| Pedestrians                     | 0                               | 0    | 0     |   | 0                               | 0    | 0     |   | 0                          | 0    | 0     |   | 0                          | 0    | 0     |   | 0     |               |
| Bicycles                        | 0                               | 0    | 0     |   | 0                               | 0    | 0     |   | 0                          | 0    | 0     |   | 0                          | 0    | 0     |   | 0     |               |
| Railroad                        |                                 |      |       |   |                                 |      |       |   |                            |      |       |   |                            |      |       |   |       |               |
| Stopped Buses                   |                                 |      |       |   |                                 |      |       |   |                            |      |       |   |                            |      |       |   |       |               |





















Comments:

HCM 2010 Signalized Intersection Summary  
 1: Trinity Parkway & Eight Mile Road

|                              |  |  |  |  |  |  |   |   |
|------------------------------|---|---|---|---|---|---|---|---|
| Movement                     | EBT   | EBR   | WBL   | WBT   | NBL   | NBR   |   |   |
| Lane Configurations          |  |   |  |  |  |  |   |   |
| Traffic Volume (veh/h)       | 602   | 14  | 739   | 396   | 19  | 672   |   |   |
| Future Volume (veh/h)        | 602   | 14  | 739   | 396   | 19  | 672   |   |   |
| Number                       | 2   | 12  | 1   | 6   | 7   | 14  |   |   |
| Initial Q (Qb), veh          | 0   | 0   | 0   | 0   | 0   | 0   |   |   |
| Ped-Bike Adj(A_pbT)          |   | 0.98  | 1.00  |   | 1.00  | 1.00  |   |   |
| Parking Bus, Adj             | 1.00  | 1.00  | 1.00  | 1.00  | 1.00  | 1.00  |   |   |
| Adj Sat Flow, veh/h/ln       | 1792  | 1900  | 1845  | 1696  | 1810  | 1845  |   |   |
| Adj Flow Rate, veh/h         | 634   | 11  | 778   | 417   | 20  | 641   |   |   |
| Adj No. of Lanes             | 4   | 0   | 2   | 2   | 2   | 2   |   |   |
| Peak Hour Factor             | 0.95  | 0.95  | 0.95  | 0.95  | 0.95  | 0.95  |   |   |
| Percent Heavy Veh, %         | 6   | 6   | 3   | 12  | 5   | 3   |   |   |
| Cap, veh/h                   | 1576  | 27  | 1058  | 2069  | 656   | 1234  |   |   |
| Arrive On Green              | 0.25  | 0.25  | 0.31  | 0.64  | 0.20  | 0.20  |   |   |
| Sat Flow, veh/h              | 6536  | 109   | 3408  | 3308  | 3343  | 2760  |   |   |
| Grp Volume(v), veh/h         | 466   | 179   | 778   | 417   | 20  | 641   |   |   |
| Grp Sat Flow(s),veh/h/ln     | 1541  | 1770  | 1704  | 1612  | 1672  | 1380  |   |   |
| Q Serve(g_s), s              | 6.2   | 6.3   | 15.1  | 3.9   | 0.4   | 12.4  |   |   |
| Cycle Q Clear(g_c), s        | 6.2   | 6.3   | 15.1  | 3.9   | 0.4   | 12.4  |   |   |
| Prop In Lane                 |   | 0.06  | 1.00  |   | 1.00  | 1.00  |   |   |
| Lane Grp Cap(c), veh/h       | 1159  | 444   | 1058  | 2069  | 656   | 1234  |   |   |
| V/C Ratio(X)                 | 0.40  | 0.40  | 0.74  | 0.20  | 0.03  | 0.52  |   |   |
| Avail Cap(c_a), veh/h        | 2182  | 835   | 1608  | 2069  | 676   | 1250  |   |   |
| HCM Platoon Ratio            | 1.00  | 1.00  | 1.00  | 1.00  | 1.00  | 1.00  |   |   |
| Upstream Filter(I)           | 1.00  | 1.00  | 1.00  | 1.00  | 1.00  | 1.00  |   |   |
| Uniform Delay (d), s/veh     | 23.1  | 23.2  | 22.9  | 5.5   | 24.1  | 14.8  |   |   |
| Incr Delay (d2), s/veh       | 0.8   | 2.1   | 2.2   | 0.2   | 0.0   | 0.2   |   |   |
| Initial Q Delay(d3),s/veh    | 0.0   | 0.0   | 0.0   | 0.0   | 0.0   | 0.0   |   |   |
| %ile BackOfQ(50%),veh/ln     | 2.7   | 3.3   | 7.4   | 1.8   | 0.2   | 6.5   |   |   |
| LnGrp Delay(d),s/veh         | 24.0  | 25.3  | 25.0  | 5.6   | 24.1  | 14.9  |   |   |
| LnGrp LOS                    | C   | C   | C   | A   | C   | B   |   |   |
| Approach Vol, veh/h          | 645   |   |   | 1195  | 661   |   |   |   |
| Approach Delay, s/veh        | 24.3  |   |   | 18.2  | 15.2  |   |   |   |
| Approach LOS                 | C   |   |   | B   | B   |   |   |   |
| Timer                        | 1   | 2   | 3   | 4   | 5   | 6   | 7 | 8 |
| Assigned Phs                 | 1   | 2   |   | 4   |   | 6   |   |   |
| Phs Duration (G+Y+Rc), s     | 29.0  | 25.6  |   | 19.6  |   | 54.6  |   |   |
| Change Period (Y+Rc), s      | 6.0   | 7.0   |   | 5.0   |   | 7.0   |   |   |
| Max Green Setting (Gmax), s  | 35.0  | 35.0  |   | 15.0  |   | 40.0  |   |   |
| Max Q Clear Time (g_c+I1), s | 17.1  | 8.3   |   | 14.4  |   | 5.9   |   |   |
| Green Ext Time (p_c), s      | 5.9   | 10.3  |   | 0.1   |   | 17.7  |   |   |
| <b>Intersection Summary</b>  |   |   |   |   |   |   |   |   |
| HCM 2010 Ctrl Delay          |   |   | 19.0  |   |   |   |   |   |
| HCM 2010 LOS                 |   |   | B   |   |   |   |   |   |

























HCM 2010 Signalized Intersection Summary  
 2: West Lane & Eight Mile Road

Stockton General Plan  
 Existing AM

|                              |  |  |  |  |  |  |   |  |  |  |  |  |
|------------------------------|---|---|---|---|---|---|---|---|---|---|---|---|
| Movement                     | EBL   | EBT   | EBR   | WBL   | WBT   | WBR   | NBL   | NBT   | NBR   | SBL   | SBT   | SBR   |
| Lane Configurations          |  |  |  |  |  |   |  |  |   |  |  |   |
| Traffic Volume (veh/h)       | 91  | 481   | 311   | 89  | 357   | 1   | 264   | 256   | 50  | 7   | 373   | 103   |
| Future Volume (veh/h)        | 91  | 481   | 311   | 89  | 357   | 1   | 264   | 256   | 50  | 7   | 373   | 103   |
| Number                       | 5   | 2   | 12  | 1   | 6   | 16  | 3   | 8   | 18  | 7   | 4   | 14  |
| Initial Q (Qb), veh          | 0   | 0   | 0   | 0   | 0   | 0   | 0   | 0   | 0   | 0   | 0   | 0   |
| Ped-Bike Adj(A_pbT)          | 1.00  |   | 1.00  | 1.00  |   | 1.00  | 1.00  |   | 1.00  | 1.00  |   | 1.00  |
| Parking Bus, Adj             | 1.00  | 1.00  | 1.00  | 1.00  | 1.00  | 1.00  | 1.00  | 1.00  | 1.00  | 1.00  | 1.00  | 1.00  |
| Adj Sat Flow, veh/h/ln       | 1776  | 1845  | 1845  | 1845  | 1793  | 1900  | 1845  | 1845  | 1900  | 1667  | 1845  | 1900  |
| Adj Flow Rate, veh/h         | 103   | 547   | 228   | 101   | 406   | 1   | 300   | 291   | 50  | 8   | 424   | 102   |
| Adj No. of Lanes             | 1   | 1   | 1   | 1   | 1   | 0   | 1   | 2   | 0   | 1   | 2   | 0   |
| Peak Hour Factor             | 0.88  | 0.88  | 0.88  | 0.88  | 0.88  | 0.88  | 0.88  | 0.88  | 0.88  | 0.88  | 0.88  | 0.88  |
| Percent Heavy Veh, %         | 7   | 3   | 3   | 3   | 6   | 6   | 3   | 3   | 3   | 14  | 3   | 3   |
| Cap, veh/h                   | 130   | 599   | 509   | 129   | 574   | 1   | 328   | 1292  | 219   | 15  | 713   | 170   |
| Arrive On Green              | 0.08  | 0.32  | 0.32  | 0.07  | 0.32  | 0.32  | 0.19  | 0.43  | 0.43  | 0.01  | 0.25  | 0.25  |
| Sat Flow, veh/h              | 1691  | 1845  | 1568  | 1757  | 1787  | 4   | 1757  | 2998  | 509   | 1587  | 2809  | 670   |
| Grp Volume(v), veh/h         | 103   | 547   | 228   | 101   | 0   | 407   | 300   | 169   | 172   | 8   | 263   | 263   |
| Grp Sat Flow(s),veh/h/ln     | 1691  | 1845  | 1568  | 1757  | 0   | 1792  | 1757  | 1752  | 1755  | 1587  | 1752  | 1726  |
| Q Serve(g_s), s              | 8.2   | 38.8  | 15.7  | 7.7   | 0.0   | 27.2  | 22.8  | 8.3   | 8.5   | 0.7   | 18.0  | 18.3  |
| Cycle Q Clear(g_c), s        | 8.2   | 38.8  | 15.7  | 7.7   | 0.0   | 27.2  | 22.8  | 8.3   | 8.5   | 0.7   | 18.0  | 18.3  |
| Prop In Lane                 | 1.00  |   | 1.00  | 1.00  |   | 0.00  | 1.00  |   | 0.29  | 1.00  |   | 0.39  |
| Lane Grp Cap(c), veh/h       | 130   | 599   | 509   | 129   | 0   | 576   | 328   | 755   | 756   | 15  | 445   | 438   |
| V/C Ratio(X)                 | 0.79  | 0.91  | 0.45  | 0.78  | 0.00  | 0.71  | 0.91  | 0.22  | 0.23  | 0.53  | 0.59  | 0.60  |
| Avail Cap(c_a), veh/h        | 372   | 609   | 517   | 386   | 0   | 591   | 386   | 771   | 772   | 349   | 771   | 759   |
| HCM Platoon Ratio            | 1.00  | 1.00  | 1.00  | 1.00  | 1.00  | 1.00  | 1.00  | 1.00  | 1.00  | 1.00  | 1.00  | 1.00  |
| Upstream Filter(I)           | 1.00  | 1.00  | 1.00  | 1.00  | 0.00  | 1.00  | 1.00  | 1.00  | 1.00  | 1.00  | 1.00  | 1.00  |
| Uniform Delay (d), s/veh     | 61.9  | 44.2  | 36.4  | 62.1  | 0.0   | 40.6  | 54.4  | 24.4  | 24.5  | 67.2  | 44.7  | 44.8  |
| Incr Delay (d2), s/veh       | 20.3  | 20.0  | 2.2   | 19.5  | 0.0   | 6.2   | 24.7  | 0.5   | 0.6   | 34.7  | 4.5   | 4.7   |
| Initial Q Delay(d3),s/veh    | 0.0   | 0.0   | 0.0   | 0.0   | 0.0   | 0.0   | 0.0   | 0.0   | 0.0   | 0.0   | 0.0   | 0.0   |
| %ile BackOfQ(50%),veh/ln     | 4.6   | 23.1  | 7.1   | 4.5   | 0.0   | 14.5  | 13.3  | 4.1   | 4.2   | 0.4   | 9.3   | 9.3   |
| LnGrp Delay(d),s/veh         | 82.2  | 64.2  | 38.6  | 81.7  | 0.0   | 46.9  | 79.1  | 25.0  | 25.0  | 102.0   | 49.2  | 49.5  |
| LnGrp LOS                    | F   | E   | D   | F   |   | D   | E   | C   | C   | F   | D   | D   |
| Approach Vol, veh/h          |   | 878   |   |   | 508   |   |   | 641   |   |   | 534   |   |
| Approach Delay, s/veh        |   | 59.7  |   |   | 53.8  |   |   | 50.3  |   |   | 50.1  |   |
| Approach LOS                 |   | E   |   |   | D   |   |   | D   |   |   | D   |   |
| Timer                        | 1   | 2   | 3   | 4   | 5   | 6   | 7   | 8   |   |   |   |   |
| Assigned Phs                 | 1   | 2   | 3   | 4   | 5   | 6   | 7   | 8   |   |   |   |   |
| Phs Duration (G+Y+Rc), s     | 15.0  | 50.3  | 30.5  | 40.6  | 15.5  | 49.8  | 6.3   | 64.8  |   |   |   |   |
| Change Period (Y+Rc), s      | 5.0   | 6.0   | 5.0   | 6.0   | 5.0   | 6.0   | 5.0   | 6.0   |   |   |   |   |
| Max Green Setting (Gmax), s  | 30.0  | 45.0  | 30.0  | 60.0  | 30.0  | 45.0  | 30.0  | 60.0  |   |   |   |   |
| Max Q Clear Time (g_c+I1), s | 9.7   | 40.8  | 24.8  | 20.3  | 10.2  | 29.2  | 2.7   | 10.5  |   |   |   |   |
| Green Ext Time (p_c), s      | 0.5   | 3.5   | 0.6   | 14.4  | 0.5   | 11.3  | 0.0   | 15.4  |   |   |   |   |
| <b>Intersection Summary</b>  |   |   |   |   |   |   |   |   |   |   |   |   |
| HCM 2010 Ctrl Delay          |   |   | 54.2  |   |   |   |   |   |   |   |   |   |
| HCM 2010 LOS                 |   |   | D   |   |   |   |   |   |   |   |   |   |





















HCM 2010 Signalized Intersection Summary  
3: West Lane & Hammer Lane























Stockton General Plan  
Existing AM

|                              |  |  |  |  |  |  |  |  |  |  |  |  |
|------------------------------|---|---|---|---|---|---|--|---|---|---|---|---|
| Movement                     | EBL   | EBT   | EBR   | WBL   | WBT   | WBR   | NBL  | NBT   | NBR   | SBL   | SBT   | SBR   |
| Lane Configurations          |  |  |  |  |  |  |  |  |  |  |  |  |
| Traffic Volume (veh/h)       | 306   | 877   | 249   | 416   | 781   | 76  | 244  | 398   | 112   | 165   | 722   | 228   |
| Future Volume (veh/h)        | 306   | 877   | 249   | 416   | 781   | 76  | 244  | 398   | 112   | 165   | 722   | 228   |
| Number                       | 7   | 4   | 14  | 3   | 8   | 18  | 5  | 2   | 12  | 1   | 6   | 16  |
| Initial Q (Qb), veh          | 0   | 0   | 0   | 0   | 0   | 0   | 0  | 0   | 0   | 0   | 0   | 0   |
| Ped-Bike Adj(A_pbT)          | 1.00  |   | 1.00  | 1.00  |   | 0.98  | 1.00   |   | 0.99  | 1.00  |   | 0.97  |
| Parking Bus, Adj             | 1.00  | 1.00  | 1.00  | 1.00  | 1.00  | 1.00  | 1.00   | 1.00  | 1.00  | 1.00  | 1.00  | 1.00  |
| Adj Sat Flow, veh/h/ln       | 1845  | 1845  | 1845  | 1845  | 1810  | 1845  | 1845   | 1845  | 1845  | 1845  | 1845  | 1827  |
| Adj Flow Rate, veh/h         | 340   | 974   | 111   | 462   | 868   | 30  | 271  | 442   | 35  | 183   | 802   | 65  |
| Adj No. of Lanes             | 2   | 4   | 1   | 2   | 4   | 1   | 2  | 4   | 1   | 2   | 4   | 1   |
| Peak Hour Factor             | 0.90  | 0.90  | 0.90  | 0.90  | 0.90  | 0.90  | 0.90   | 0.90  | 0.90  | 0.90  | 0.90  | 0.90  |
| Percent Heavy Veh, %         | 3   | 3   | 3   | 3   | 5   | 3   | 3  | 3   | 3   | 3   | 3   | 4   |
| Cap, veh/h                   | 392   | 2195  | 540   | 508   | 2365  | 585   | 320  | 1820  | 447   | 233   | 1657  | 393   |
| Arrive On Green              | 0.11  | 0.35  | 0.35  | 0.15  | 0.38  | 0.38  | 0.09   | 0.29  | 0.29  | 0.07  | 0.26  | 0.26  |
| Sat Flow, veh/h              | 3408  | 6346  | 1561  | 3408  | 6225  | 1539  | 3408   | 6346  | 1558  | 3408  | 6346  | 1503  |
| Grp Volume(v), veh/h         | 340   | 974   | 111   | 462   | 868   | 30  | 271  | 442   | 35  | 183   | 802   | 65  |
| Grp Sat Flow(s),veh/h/ln     | 1704  | 1586  | 1561  | 1704  | 1556  | 1539  | 1704   | 1586  | 1558  | 1704  | 1586  | 1503  |
| Q Serve(g_s), s              | 13.7  | 16.6  | 7.0   | 18.7  | 14.1  | 1.7   | 11.0   | 7.5   | 2.3   | 7.4   | 15.0  | 4.7   |
| Cycle Q Clear(g_c), s        | 13.7  | 16.6  | 7.0   | 18.7  | 14.1  | 1.7   | 11.0   | 7.5   | 2.3   | 7.4   | 15.0  | 4.7   |
| Prop In Lane                 | 1.00  |   | 1.00  | 1.00  |   | 1.00  | 1.00   |   | 1.00  | 1.00  |   | 1.00  |
| Lane Grp Cap(c), veh/h       | 392   | 2195  | 540   | 508   | 2365  | 585   | 320  | 1820  | 447   | 233   | 1657  | 393   |
| V/C Ratio(X)                 | 0.87  | 0.44  | 0.21  | 0.91  | 0.37  | 0.05  | 0.85   | 0.24  | 0.08  | 0.79  | 0.48  | 0.17  |
| Avail Cap(c_a), veh/h        | 536   | 2195  | 540   | 536   | 2365  | 585   | 414  | 1904  | 467   | 414   | 1904  | 451   |
| HCM Platoon Ratio            | 1.00  | 1.00  | 1.00  | 1.00  | 1.00  | 1.00  | 1.00   | 1.00  | 1.00  | 1.00  | 1.00  | 1.00  |
| Upstream Filter(I)           | 1.00  | 1.00  | 1.00  | 1.00  | 1.00  | 1.00  | 1.00   | 1.00  | 1.00  | 1.00  | 1.00  | 1.00  |
| Uniform Delay (d), s/veh     | 60.9  | 35.4  | 32.2  | 58.7  | 31.3  | 27.5  | 62.4   | 38.3  | 36.4  | 64.2  | 43.7  | 39.9  |
| Incr Delay (d2), s/veh       | 8.6   | 0.7   | 0.9   | 18.5  | 0.4   | 0.2   | 9.9  | 0.2   | 0.3   | 2.2   | 0.8   | 0.7   |
| Initial Q Delay(d3),s/veh    | 0.0   | 0.0   | 0.0   | 0.0   | 0.0   | 0.0   | 0.0  | 0.0   | 0.0   | 0.0   | 0.0   | 0.0   |
| %ile BackOfQ(50%),veh/ln     | 6.9   | 7.4   | 3.1   | 10.1  | 6.1   | 0.8   | 5.6  | 3.3   | 1.0   | 3.6   | 6.7   | 2.0   |
| LnGrp Delay(d),s/veh         | 69.5  | 36.0  | 33.1  | 77.1  | 31.7  | 27.6  | 72.3   | 38.5  | 36.7  | 66.4  | 44.5  | 40.7  |
| LnGrp LOS                    | E   | D   | C   | E   | C   | C   | E  | D   | D   | E   | D   | D   |
| Approach Vol, veh/h          |   | 1425  |   |   | 1360  |   |  | 748   |   |   | 1050  |   |
| Approach Delay, s/veh        |   | 43.8  |   |   | 47.0  |   |  | 50.7  |   |   | 48.1  |   |
| Approach LOS                 |   | D   |   |   | D   |   |  | D   |   |   | D   |   |
| Timer                        | 1   | 2   | 3   | 4   | 5   | 6   | 7  | 8   |   |   |   |   |
| Assigned Phs                 | 1   | 2   | 3   | 4   | 5   | 6   | 7  | 8   |   |   |   |   |
| Phs Duration (G+Y+Rc), s     | 14.6  | 46.1  | 25.8  | 53.4  | 18.2  | 42.6  | 21.1   | 58.2  |   |   |   |   |
| Change Period (Y+Rc), s      | 5.0   | 6.0   | 5.0   | 5.0   | 5.0   | 6.0   | 5.0  | 5.0   |   |   |   |   |
| Max Green Setting (Gmax), s  | 17.0  | 42.0  | 22.0  | 38.0  | 17.0  | 42.0  | 22.0   | 38.0  |   |   |   |   |
| Max Q Clear Time (g_c+I1), s | 9.4   | 9.5   | 20.7  | 18.6  | 13.0  | 17.0  | 15.7   | 16.1  |   |   |   |   |
| Green Ext Time (p_c), s      | 0.2   | 22.1  | 0.2   | 17.9  | 0.2   | 18.2  | 0.4  | 20.1  |   |   |   |   |
| <b>Intersection Summary</b>  |   |   |   |   |   |   |  |   |   |   |   |   |
| HCM 2010 Ctrl Delay          |   |   | 46.9  |   |   |   |  |   |   |   |   |   |
| HCM 2010 LOS                 |   |   | D   |   |   |   |  |   |   |   |   |   |

HCM 2010 Signalized Intersection Summary  
4: Holman Road & Hammer Lane

Stockton General Plan  
Existing AM

|                              |  |  |  |  |  |  |  |  |  |  |  |  |
|------------------------------|---|---|---|---|---|---|--|---|---|---|---|---|
| Movement                     | EBL   | EBT   | EBR   | WBL   | WBT   | WBR   | NBL  | NBT   | NBR   | SBL   | SBT   | SBR   |
| Lane Configurations          |  |  |   |  |  |   |  |  |   |  |  |  |
| Traffic Volume (veh/h)       | 248   | 917   | 178   | 245   | 1001  | 61  | 171  | 234   | 16  | 199   | 353   | 207   |
| Future Volume (veh/h)        | 248   | 917   | 178   | 245   | 1001  | 61  | 171  | 234   | 16  | 199   | 353   | 207   |
| Number                       | 5   | 2   | 12  | 1   | 6   | 16  | 7  | 4   | 14  | 3   | 8   | 18  |
| Initial Q (Qb), veh          | 0   | 0   | 0   | 0   | 0   | 0   | 0  | 0   | 0   | 0   | 0   | 0   |
| Ped-Bike Adj(A_pbT)          | 1.00  |   | 1.00  | 1.00  |   | 0.98  | 1.00   |   | 0.97  | 1.00  |   | 0.95  |
| Parking Bus, Adj             | 1.00  | 1.00  | 1.00  | 1.00  | 1.00  | 1.00  | 1.00   | 1.00  | 1.00  | 1.00  | 1.00  | 1.00  |
| Adj Sat Flow, veh/h/ln       | 1845  | 1845  | 1900  | 1845  | 1828  | 1900  | 1827   | 1833  | 1900  | 1845  | 1845  | 1810  |
| Adj Flow Rate, veh/h         | 258   | 955   | 159   | 255   | 1043  | 57  | 178  | 244   | 10  | 207   | 368   | 40  |
| Adj No. of Lanes             | 2   | 4   | 0   | 2   | 4   | 0   | 2  | 3   | 0   | 2   | 3   | 1   |
| Peak Hour Factor             | 0.96  | 0.96  | 0.96  | 0.96  | 0.96  | 0.96  | 0.96   | 0.96  | 0.96  | 0.96  | 0.96  | 0.96  |
| Percent Heavy Veh, %         | 3   | 3   | 3   | 3   | 4   | 4   | 4  | 3   | 3   | 3   | 3   | 5   |
| Cap, veh/h                   | 926   | 2751  | 452   | 316   | 1899  | 103   | 238  | 691   | 28  | 269   | 749   | 218   |
| Arrive On Green              | 0.27  | 0.50  | 0.50  | 0.09  | 0.31  | 0.31  | 0.07   | 0.14  | 0.14  | 0.08  | 0.15  | 0.15  |
| Sat Flow, veh/h              | 3408  | 5534  | 909   | 3408  | 6145  | 334   | 3375   | 4928  | 200   | 3408  | 5036  | 1467  |
| Grp Volume(v), veh/h         | 258   | 819   | 295   | 255   | 799   | 301   | 178  | 164   | 90  | 207   | 368   | 40  |
| Grp Sat Flow(s),veh/h/ln     | 1704  | 1586  | 1683  | 1704  | 1572  | 1763  | 1688   | 1668  | 1791  | 1704  | 1679  | 1467  |
| Q Serve(g_s), s              | 6.6   | 11.5  | 11.7  | 8.1   | 15.5  | 15.6  | 5.7  | 4.9   | 5.0   | 6.6   | 7.4   | 2.6   |
| Cycle Q Clear(g_c), s        | 6.6   | 11.5  | 11.7  | 8.1   | 15.5  | 15.6  | 5.7  | 4.9   | 5.0   | 6.6   | 7.4   | 2.6   |
| Prop In Lane                 | 1.00  |   | 0.54  | 1.00  |   | 0.19  | 1.00   |   | 0.11  | 1.00  |   | 1.00  |
| Lane Grp Cap(c), veh/h       | 926   | 2366  | 837   | 316   | 1458  | 545   | 238  | 468   | 251   | 269   | 749   | 218   |
| V/C Ratio(X)                 | 0.28  | 0.35  | 0.35  | 0.81  | 0.55  | 0.55  | 0.75   | 0.35  | 0.36  | 0.77  | 0.49  | 0.18  |
| Avail Cap(c_a), veh/h        | 926   | 2366  | 837   | 403   | 1458  | 545   | 338  | 758   | 407   | 403   | 1236  | 360   |
| HCM Platoon Ratio            | 1.00  | 1.00  | 1.00  | 1.00  | 1.00  | 1.00  | 1.00   | 1.00  | 1.00  | 1.00  | 1.00  | 1.00  |
| Upstream Filter(I)           | 1.00  | 1.00  | 1.00  | 1.00  | 1.00  | 1.00  | 1.00   | 1.00  | 1.00  | 1.00  | 1.00  | 1.00  |
| Uniform Delay (d), s/veh     | 31.6  | 16.8  | 16.9  | 48.9  | 31.6  | 31.7  | 50.2   | 42.8  | 42.8  | 49.7  | 43.0  | 41.0  |
| Incr Delay (d2), s/veh       | 0.1   | 0.4   | 1.2   | 7.1   | 1.5   | 4.0   | 2.9  | 0.2   | 0.3   | 2.3   | 0.2   | 0.1   |
| Initial Q Delay(d3),s/veh    | 0.0   | 0.0   | 0.0   | 0.0   | 0.0   | 0.0   | 0.0  | 0.0   | 0.0   | 0.0   | 0.0   | 0.0   |
| %ile BackOfQ(50%),veh/ln     | 3.1   | 5.1   | 5.7   | 4.1   | 6.9   | 8.2   | 2.7  | 2.3   | 2.5   | 3.2   | 3.5   | 1.1   |
| LnGrp Delay(d),s/veh         | 31.6  | 17.2  | 18.0  | 56.0  | 33.1  | 35.6  | 53.0   | 42.9  | 43.1  | 52.0  | 43.2  | 41.1  |
| LnGrp LOS                    | C   | B   | B   | E   | C   | D   | D  | D   | D   | D   | D   | D   |
| Approach Vol, veh/h          |   | 1372  |   |   | 1355  |   |  | 432   |   |   | 615   |   |
| Approach Delay, s/veh        |   | 20.1  |   |   | 38.0  |   |  | 47.1  |   |   | 46.0  |   |
| Approach LOS                 |   | C   |   |   | D   |   |  | D   |   |   | D   |   |
| Timer                        | 1   | 2   | 3   | 4   | 5   | 6   | 7  | 8   |   |   |   |   |
| Assigned Phs                 | 1   | 2   | 3   | 4   | 5   | 6   | 7  | 8   |   |   |   |   |
| Phs Duration (G+Y+Rc), s     | 15.2  | 60.7  | 13.7  | 20.4  | 35.9  | 40.0  | 12.7   | 21.3  |   |   |   |   |
| Change Period (Y+Rc), s      | 5.0   | 6.0   | 5.0   | 5.0   | 6.0   | * 6   | 5.0  | 5.0   |   |   |   |   |
| Max Green Setting (Gmax), s  | 13.0  | 38.0  | 13.0  | 25.0  | 17.0  | * 34  | 11.0   | 27.0  |   |   |   |   |
| Max Q Clear Time (g_c+I1), s | 10.1  | 13.7  | 8.6   | 7.0   | 8.6   | 17.6  | 7.7  | 9.4   |   |   |   |   |
| Green Ext Time (p_c), s      | 0.1   | 16.0  | 0.1   | 2.4   | 5.0   | 11.6  | 0.1  | 2.4   |   |   |   |   |
| <b>Intersection Summary</b>  |   |   |   |   |   |   |  |   |   |   |   |   |
| HCM 2010 Ctrl Delay          |   |   | 33.8  |   |   |   |  |   |   |   |   |   |
| HCM 2010 LOS                 |   |   | C   |   |   |   |  |   |   |   |   |   |
| <b>Notes</b>                 |   |   |   |   |   |   |  |   |   |   |   |   |

|                              |  |  |  |  |  |  |  |  |  |  |  |  |
|------------------------------|---|---|---|---|---|---|--|---|---|---|---|---|
| Movement                     | EBL   | EBT   | EBR   | WBL   | WBT   | WBR   | NBL  | NBT   | NBR   | SBL   | SBT   | SBR   |
| Lane Configurations          |   |  |  |  |  |   |   |  |  |  |  |  |
| Traffic Volume (veh/h)       | 26  | 79  | 47  | 637   | 52  | 21  | 42   | 382   | 367   | 18  | 778   | 18  |
| Future Volume (veh/h)        | 26  | 79  | 47  | 637   | 52  | 21  | 42   | 382   | 367   | 18  | 778   | 18  |
| Number                       | 7   | 4   | 14  | 3   | 8   | 18  | 5  | 2   | 12  | 1   | 6   | 16  |
| Initial Q (Qb), veh          | 0   | 0   | 0   | 0   | 0   | 0   | 0  | 0   | 0   | 0   | 0   | 0   |
| Ped-Bike Adj(A_pbT)          | 1.00  |   | 1.00  | 1.00  |   | 1.00  | 1.00   |   | 1.00  | 1.00  |   | 0.97  |
| Parking Bus, Adj             | 1.00  | 1.00  | 1.00  | 1.00  | 1.00  | 1.00  | 1.00   | 1.00  | 1.00  | 1.00  | 1.00  | 1.00  |
| Adj Sat Flow, veh/h/ln       | 1900  | 1845  | 1845  | 1827  | 1821  | 1900  | 1845   | 1827  | 1845  | 1845  | 1843  | 1900  |
| Adj Flow Rate, veh/h         | 28  | 85  | 5   | 725   | 0   | 0   | 45   | 411   | 0   | 19  | 837   | 17  |
| Adj No. of Lanes             | 0   | 1   | 1   | 2   | 1   | 0   | 1  | 2   | 1   | 1   | 3   | 0   |
| Peak Hour Factor             | 0.93  | 0.93  | 0.93  | 0.93  | 0.93  | 0.93  | 0.93   | 0.93  | 0.93  | 0.93  | 0.93  | 0.93  |
| Percent Heavy Veh, %         | 3   | 3   | 3   | 4   | 4   | 4   | 3  | 4   | 3   | 3   | 3   | 3   |
| Cap, veh/h                   | 35  | 106   | 122   | 838   | 438   | 0   | 415  | 1679  | 759   | 28  | 1338  | 27  |
| Arrive On Green              | 0.08  | 0.08  | 0.08  | 0.24  | 0.00  | 0.00  | 0.24   | 0.48  | 0.00  | 0.02  | 0.26  | 0.26  |
| Sat Flow, veh/h              | 451   | 1371  | 1568  | 3480  | 1821  | 0   | 1757   | 3471  | 1568  | 1757  | 5074  | 103   |
| Grp Volume(v), veh/h         | 113   | 0   | 5   | 725   | 0   | 0   | 45   | 411   | 0   | 19  | 553   | 301   |
| Grp Sat Flow(s),veh/h/ln     | 1822  | 0   | 1568  | 1740  | 1821  | 0   | 1757   | 1736  | 1568  | 1757  | 1678  | 1822  |
| Q Serve(g_s), s              | 6.7   | 0.0   | 0.3   | 22.0  | 0.0   | 0.0   | 2.2  | 7.6   | 0.0   | 1.2   | 16.0  | 16.0  |
| Cycle Q Clear(g_c), s        | 6.7   | 0.0   | 0.3   | 22.0  | 0.0   | 0.0   | 2.2  | 7.6   | 0.0   | 1.2   | 16.0  | 16.0  |
| Prop In Lane                 | 0.25  |   | 1.00  | 1.00  |   | 0.00  | 1.00   |   | 1.00  | 1.00  |   | 0.06  |
| Lane Grp Cap(c), veh/h       | 141   | 0   | 122   | 838   | 438   | 0   | 415  | 1679  | 759   | 28  | 885   | 480   |
| V/C Ratio(X)                 | 0.80  | 0.00  | 0.04  | 0.87  | 0.00  | 0.00  | 0.11   | 0.24  | 0.00  | 0.68  | 0.63  | 0.63  |
| Avail Cap(c_a), veh/h        | 182   | 0   | 157   | 1265  | 662   | 0   | 415  | 1679  | 759   | 128   | 885   | 480   |
| HCM Platoon Ratio            | 1.00  | 1.00  | 1.00  | 1.00  | 1.00  | 1.00  | 1.00   | 1.00  | 1.00  | 1.00  | 1.00  | 1.00  |
| Upstream Filter(I)           | 1.00  | 0.00  | 1.00  | 1.00  | 0.00  | 0.00  | 1.00   | 1.00  | 0.00  | 1.00  | 1.00  | 1.00  |
| Uniform Delay (d), s/veh     | 49.9  | 0.0   | 46.9  | 40.1  | 0.0   | 0.0   | 32.9   | 16.6  | 0.0   | 53.8  | 35.7  | 35.7  |
| Incr Delay (d2), s/veh       | 13.3  | 0.0   | 0.1   | 4.3   | 0.0   | 0.0   | 0.0  | 0.3   | 0.0   | 10.0  | 3.3   | 6.1   |
| Initial Q Delay(d3),s/veh    | 0.0   | 0.0   | 0.0   | 0.0   | 0.0   | 0.0   | 0.0  | 0.0   | 0.0   | 0.0   | 0.0   | 0.0   |
| %ile BackOfQ(50%),veh/ln     | 3.9   | 0.0   | 0.1   | 11.1  | 0.0   | 0.0   | 1.1  | 3.7   | 0.0   | 0.7   | 7.8   | 8.8   |
| LnGrp Delay(d),s/veh         | 63.2  | 0.0   | 47.0  | 44.3  | 0.0   | 0.0   | 33.0   | 17.0  | 0.0   | 63.8  | 39.0  | 41.8  |
| LnGrp LOS                    | E   |   | D   | D   |   |   | C  | B   |   | E   | D   | D   |
| Approach Vol, veh/h          |   | 118   |   |   | 725   |   |  | 456   |   |   | 873   |   |
| Approach Delay, s/veh        |   | 62.5  |   |   | 44.3  |   |  | 18.5  |   |   | 40.5  |   |
| Approach LOS                 |   | E   |   |   | D   |   |  | B   |   |   | D   |   |
| Timer                        | 1   | 2   | 3   | 4   | 5   | 6   | 7  | 8   |   |   |   |   |
| Assigned Phs                 | 1   | 2   |   | 4   | 5   | 6   |  | 8   |   |   |   |   |
| Phs Duration (G+Y+Rc), s     | 6.8   | 58.2  |   | 13.5  | 31.0  | 34.0  |  | 31.5  |   |   |   |   |
| Change Period (Y+Rc), s      | 5.0   | 5.0   |   | 5.0   | 5.0   | 5.0   |  | 5.0   |   |   |   |   |
| Max Green Setting (Gmax), s  | 8.0   | 31.0  |   | 11.0  | 10.0  | 29.0  |  | 40.0  |   |   |   |   |
| Max Q Clear Time (g_c+I1), s | 3.2   | 9.6   |   | 8.7   | 4.2   | 18.0  |  | 24.0  |   |   |   |   |
| Green Ext Time (p_c), s      | 0.0   | 5.7   |   | 0.1   | 1.3   | 7.1   |  | 2.5   |   |   |   |   |
| <b>Intersection Summary</b>  |   |   |   |   |   |   |  |   |   |   |   |   |
| HCM 2010 Ctrl Delay          |   |   | 38.4  |   |   |   |  |   |   |   |   |   |
| HCM 2010 LOS                 |   |   | D   |   |   |   |  |   |   |   |   |   |
| <b>Notes</b>                 |   |   |   |   |   |   |  |   |   |   |   |   |

HCM 2010 Signalized Intersection Summary  
6: Feather River Drive & March Lane























Stockton General Plan  
Existing AM

| Movement                     | EBL  | EBT  | EBR  | WBL   | WBT  | WBR  | NBL  | NBT   | NBR   | SBL  | SBT  | SBR  |
|------------------------------|------|------|------|-------|------|------|------|-------|-------|------|------|------|
| Lane Configurations          |      |      |      |       |      |      |      |       |       |      |      |      |
| Traffic Volume (veh/h)       | 87   | 951  | 32   | 281   | 1090 | 114  | 69   | 152   | 245   | 376  | 146  | 51   |
| Future Volume (veh/h)        | 87   | 951  | 32   | 281   | 1090 | 114  | 69   | 152   | 245   | 376  | 146  | 51   |
| Number                       | 5    | 2    | 12   | 1     | 6    | 16   | 7    | 4     | 14    | 3    | 8    | 18   |
| Initial Q (Qb), veh          | 0    | 0    | 0    | 0     | 0    | 0    | 0    | 0     | 0     | 0    | 0    | 0    |
| Ped-Bike Adj(A_pbT)          | 1.00 |      | 0.99 | 1.00  |      | 1.00 | 1.00 |       | 1.00  | 1.00 |      | 0.98 |
| Parking Bus, Adj             | 1.00 | 1.00 | 1.00 | 1.00  | 1.00 | 1.00 | 1.00 | 1.00  | 1.00  | 1.00 | 1.00 | 1.00 |
| Adj Sat Flow, veh/h/ln       | 1827 | 1843 | 1900 | 1845  | 1845 | 1900 | 1845 | 1845  | 1900  | 1845 | 1842 | 1900 |
| Adj Flow Rate, veh/h         | 101  | 1106 | 34   | 327   | 1267 | 123  | 80   | 177   | 232   | 329  | 321  | 51   |
| Adj No. of Lanes             | 1    | 3    | 0    | 1     | 3    | 0    | 1    | 1     | 0     | 1    | 1    | 0    |
| Peak Hour Factor             | 0.86 | 0.86 | 0.86 | 0.86  | 0.86 | 0.86 | 0.86 | 0.86  | 0.86  | 0.86 | 0.86 | 0.86 |
| Percent Heavy Veh, %         | 4    | 3    | 3    | 3     | 3    | 3    | 3    | 3     | 3     | 3    | 3    | 3    |
| Cap, veh/h                   | 126  | 1324 | 41   | 319   | 1745 | 169  | 240  | 99    | 130   | 415  | 365  | 58   |
| Arrive On Green              | 0.07 | 0.26 | 0.26 | 0.18  | 0.37 | 0.37 | 0.14 | 0.14  | 0.14  | 0.24 | 0.24 | 0.24 |
| Sat Flow, veh/h              | 1740 | 5015 | 154  | 1757  | 4668 | 453  | 1757 | 725   | 950   | 1757 | 1547 | 246  |
| Grp Volume(v), veh/h         | 101  | 740  | 400  | 327   | 911  | 479  | 80   | 0     | 409   | 329  | 0    | 372  |
| Grp Sat Flow(s),veh/h/ln     | 1740 | 1677 | 1815 | 1757  | 1679 | 1764 | 1757 | 0     | 1675  | 1757 | 0    | 1793 |
| Q Serve(g_s), s              | 6.3  | 22.9 | 22.9 | 20.0  | 25.7 | 25.7 | 4.5  | 0.0   | 15.0  | 19.4 | 0.0  | 22.0 |
| Cycle Q Clear(g_c), s        | 6.3  | 22.9 | 22.9 | 20.0  | 25.7 | 25.7 | 4.5  | 0.0   | 15.0  | 19.4 | 0.0  | 22.0 |
| Prop In Lane                 | 1.00 |      | 0.08 | 1.00  |      | 0.26 | 1.00 |       | 0.57  | 1.00 |      | 0.14 |
| Lane Grp Cap(c), veh/h       | 126  | 886  | 479  | 319   | 1255 | 659  | 240  | 0     | 228   | 415  | 0    | 423  |
| V/C Ratio(X)                 | 0.80 | 0.84 | 0.84 | 1.02  | 0.73 | 0.73 | 0.33 | 0.00  | 1.79  | 0.79 | 0.00 | 0.88 |
| Avail Cap(c_a), veh/h        | 174  | 886  | 479  | 319   | 1255 | 659  | 240  | 0     | 228   | 479  | 0    | 489  |
| HCM Platoon Ratio            | 1.00 | 1.00 | 1.00 | 1.00  | 1.00 | 1.00 | 1.00 | 1.00  | 1.00  | 1.00 | 1.00 | 1.00 |
| Upstream Filter(I)           | 1.00 | 1.00 | 1.00 | 1.00  | 1.00 | 1.00 | 1.00 | 0.00  | 1.00  | 1.00 | 0.00 | 1.00 |
| Uniform Delay (d), s/veh     | 50.3 | 38.2 | 38.2 | 45.0  | 29.6 | 29.6 | 43.0 | 0.0   | 47.5  | 39.5 | 0.0  | 40.5 |
| Incr Delay (d2), s/veh       | 11.9 | 9.2  | 15.8 | 56.6  | 3.7  | 6.9  | 0.3  | 0.0   | 373.0 | 7.8  | 0.0  | 15.2 |
| Initial Q Delay(d3),s/veh    | 0.0  | 0.0  | 0.0  | 0.0   | 0.0  | 0.0  | 0.0  | 0.0   | 0.0   | 0.0  | 0.0  | 0.0  |
| %ile BackOfQ(50%),veh/ln     | 3.4  | 11.7 | 13.6 | 14.7  | 12.5 | 13.8 | 2.2  | 0.0   | 30.6  | 10.3 | 0.0  | 12.6 |
| LnGrp Delay(d),s/veh         | 62.1 | 47.4 | 54.0 | 101.6 | 33.3 | 36.5 | 43.3 | 0.0   | 420.5 | 47.3 | 0.0  | 55.7 |
| LnGrp LOS                    | E    | D    | D    | F     | C    | D    | D    |       | F     | D    |      | E    |
| Approach Vol, veh/h          |      | 1241 |      |       | 1717 |      |      | 489   |       |      | 701  |      |
| Approach Delay, s/veh        |      | 50.7 |      |       | 47.2 |      |      | 358.8 |       |      | 51.8 |      |
| Approach LOS                 |      | D    |      |       | D    |      |      | F     |       |      | D    |      |
| Timer                        | 1    | 2    | 3    | 4     | 5    | 6    | 7    | 8     |       |      |      |      |
| Assigned Phs                 | 1    | 2    |      | 4     | 5    | 6    |      | 8     |       |      |      |      |
| Phs Duration (G+Y+Rc), s     | 25.0 | 34.0 |      | 20.0  | 12.9 | 46.1 |      | 31.0  |       |      |      |      |
| Change Period (Y+Rc), s      | 5.0  | 5.0  |      | 5.0   | 5.0  | 5.0  |      | 5.0   |       |      |      |      |
| Max Green Setting (Gmax), s  | 20.0 | 25.0 |      | 15.0  | 11.0 | 34.0 |      | 30.0  |       |      |      |      |
| Max Q Clear Time (g_c+I1), s | 22.0 | 24.9 |      | 17.0  | 8.3  | 27.7 |      | 24.0  |       |      |      |      |
| Green Ext Time (p_c), s      | 0.0  | 0.1  |      | 0.0   | 0.0  | 6.3  |      | 1.8   |       |      |      |      |
| <b>Intersection Summary</b>  |      |      |      |       |      |      |      |       |       |      |      |      |
| HCM 2010 Ctrl Delay          | 85.8 |      |      |       |      |      |      |       |       |      |      |      |
| HCM 2010 LOS                 | F    |      |      |       |      |      |      |       |       |      |      |      |
| <b>Notes</b>                 |      |      |      |       |      |      |      |       |       |      |      |      |























HCM 2010 Signalized Intersection Summary  
7: Pacific Avenue & March Lane

Stockton General Plan  
Existing AM

|                              |  |  |  |  |  |  |  |  |  |  |  |  |
|------------------------------|---|---|---|---|---|---|--|---|---|---|---|---|
| Movement                     | EBL   | EBT   | EBR   | WBL   | WBT   | WBR   | NBL  | NBT   | NBR   | SBL   | SBT   | SBR   |
| Lane Configurations          |  |  |  |  |  |   |   |    |    |    |    |    |
| Traffic Volume (veh/h)       | 218   | 894   | 183   | 166   | 772   | 93  | 156  | 335   | 52  | 116   | 761   | 114   |
| Future Volume (veh/h)        | 218   | 894   | 183   | 166   | 772   | 93  | 156  | 335   | 52  | 116   | 761   | 114   |
| Number                       | 5   | 2   | 12  | 1   | 6   | 16  | 3  | 8   | 18  | 7   | 4   | 14  |
| Initial Q (Qb), veh          | 0   | 0   | 0   | 0   | 0   | 0   | 0  | 0   | 0   | 0   | 0   | 0   |
| Ped-Bike Adj(A_pbT)          | 1.00  |   | 0.98  | 1.00  |   | 1.00  | 1.00   |   | 1.00  | 1.00  |   | 0.99  |
| Parking Bus, Adj             | 1.00  | 1.00  | 1.00  | 1.00  | 1.00  | 1.00  | 1.00   | 1.00  | 1.00  | 1.00  | 1.00  | 1.00  |
| Adj Sat Flow, veh/h/ln       | 1845  | 1845  | 1845  | 1845  | 1829  | 1900  | 1845   | 1810  | 1827  | 1845  | 1842  | 1900  |
| Adj Flow Rate, veh/h         | 232   | 951   | 91  | 177   | 821   | 86  | 166  | 356   | 15  | 123   | 810   | 103   |
| Adj No. of Lanes             | 2   | 3   | 1   | 2   | 3   | 0   | 2  | 3   | 1   | 2   | 3   | 0   |
| Peak Hour Factor             | 0.94  | 0.94  | 0.94  | 0.94  | 0.94  | 0.94  | 0.94   | 0.94  | 0.94  | 0.94  | 0.94  | 0.94  |
| Percent Heavy Veh, %         | 3   | 3   | 3   | 3   | 3   | 3   | 3  | 5   | 4   | 3   | 3   | 3   |
| Cap, veh/h                   | 683   | 2212  | 678   | 239   | 1420  | 148   | 246  | 1261  | 396   | 182   | 1069  | 135   |
| Arrive On Green              | 0.20  | 0.44  | 0.44  | 0.07  | 0.31  | 0.31  | 0.07   | 0.26  | 0.26  | 0.05  | 0.24  | 0.24  |
| Sat Flow, veh/h              | 3408  | 5036  | 1544  | 3408  | 4593  | 479   | 3408   | 4940  | 1549  | 3408  | 4520  | 571   |
| Grp Volume(v), veh/h         | 232   | 951   | 91  | 177   | 594   | 313   | 166  | 356   | 15  | 123   | 600   | 313   |
| Grp Sat Flow(s),veh/h/ln     | 1704  | 1679  | 1544  | 1704  | 1665  | 1743  | 1704   | 1647  | 1549  | 1704  | 1677  | 1738  |
| Q Serve(g_s), s              | 6.4   | 14.4  | 2.7   | 5.6   | 16.5  | 16.6  | 5.2  | 6.4   | 0.8   | 3.9   | 18.3  | 18.5  |
| Cycle Q Clear(g_c), s        | 6.4   | 14.4  | 2.7   | 5.6   | 16.5  | 16.6  | 5.2  | 6.4   | 0.8   | 3.9   | 18.3  | 18.5  |
| Prop In Lane                 | 1.00  |   | 1.00  | 1.00  |   | 0.27  | 1.00   |   | 1.00  | 1.00  |   | 0.33  |
| Lane Grp Cap(c), veh/h       | 683   | 2212  | 678   | 239   | 1029  | 539   | 246  | 1261  | 396   | 182   | 793   | 411   |
| V/C Ratio(X)                 | 0.34  | 0.43  | 0.13  | 0.74  | 0.58  | 0.58  | 0.67   | 0.28  | 0.04  | 0.68  | 0.76  | 0.76  |
| Avail Cap(c_a), veh/h        | 683   | 2212  | 678   | 434   | 1029  | 539   | 434  | 1261  | 396   | 465   | 854   | 442   |
| HCM Platoon Ratio            | 1.00  | 1.00  | 1.00  | 1.00  | 1.00  | 1.00  | 1.00   | 1.00  | 1.00  | 1.00  | 1.00  | 1.00  |
| Upstream Filter(I)           | 1.00  | 1.00  | 1.00  | 1.00  | 1.00  | 1.00  | 1.00   | 1.00  | 1.00  | 1.00  | 1.00  | 1.00  |
| Uniform Delay (d), s/veh     | 37.7  | 21.3  | 9.2   | 50.2  | 32.0  | 32.0  | 49.8   | 32.9  | 30.8  | 51.1  | 39.0  | 39.1  |
| Incr Delay (d2), s/veh       | 0.1   | 0.6   | 0.4   | 1.7   | 2.4   | 4.5   | 1.2  | 0.4   | 0.1   | 1.6   | 5.8   | 11.1  |
| Initial Q Delay(d3),s/veh    | 0.0   | 0.0   | 0.0   | 0.0   | 0.0   | 0.0   | 0.0  | 0.0   | 0.0   | 0.0   | 0.0   | 0.0   |
| %ile BackOfQ(50%),veh/ln     | 3.0   | 6.7   | 1.2   | 2.7   | 7.9   | 8.7   | 2.5  | 3.0   | 0.4   | 1.9   | 9.1   | 10.1  |
| LnGrp Delay(d),s/veh         | 37.8  | 21.9  | 9.7   | 51.8  | 34.3  | 36.5  | 51.0   | 33.3  | 30.9  | 52.8  | 44.9  | 50.2  |
| LnGrp LOS                    | D   | C   | A   | D   | C   | D   | D  | C   | C   | D   | D   | D   |
| Approach Vol, veh/h          |   | 1274  |   |   | 1084  |   |  | 537   |   |   | 1036  |   |
| Approach Delay, s/veh        |   | 24.0  |   |   | 37.8  |   |  | 38.7  |   |   | 47.4  |   |
| Approach LOS                 |   | C   |   |   | D   |   |  | D   |   |   | D   |   |
| Timer                        | 1   | 2   | 3   | 4   | 5   | 6   | 7  | 8   |   |   |   |   |
| Assigned Phs                 | 1   | 2   | 3   | 4   | 5   | 6   | 7  | 8   |   |   |   |   |
| Phs Duration (G+Y+Rc), s     | 12.7  | 53.3  | 12.9  | 31.0  | 27.0  | 39.0  | 10.9   | 33.1  |   |   |   |   |
| Change Period (Y+Rc), s      | 5.0   | 5.0   | 5.0   | 5.0   | 5.0   | 5.0   | 5.0  | 5.0   |   |   |   |   |
| Max Green Setting (Gmax), s  | 14.0  | 34.0  | 14.0  | 28.0  | 14.0  | 34.0  | 15.0   | 27.0  |   |   |   |   |
| Max Q Clear Time (g_c+I1), s | 7.6   | 16.4  | 7.2   | 20.5  | 8.4   | 18.6  | 5.9  | 8.4   |   |   |   |   |
| Green Ext Time (p_c), s      | 0.2   | 12.0  | 0.8   | 5.4   | 0.8   | 9.6   | 0.1  | 4.8   |   |   |   |   |
| <b>Intersection Summary</b>  |   |   |   |   |   |   |  |   |   |   |   |   |
| HCM 2010 Ctrl Delay          |   |   | 36.0  |   |   |   |  |   |   |   |   |   |
| HCM 2010 LOS                 |   |   | D   |   |   |   |  |   |   |   |   |   |
| <b>Notes</b>                 |   |   |   |   |   |   |  |   |   |   |   |   |



























HCM 2010 Signalized Intersection Summary  
 8: Pershing Avenue & Country Club Boulevard

Stockton General Plan  
 Existing AM

|                              |  |  |  |  |  |  |  |  |  |  |  |  |
|------------------------------|---|---|---|---|---|---|--|---|---|---|---|---|
| Movement                     | EBL   | EBT   | EBR   | WBL   | WBT   | WBR   | NBL  | NBT   | NBR   | SBL   | SBT   | SBR   |
| Lane Configurations          |  |  |   |  |  |   |  |  |   |  |  |  |
| Traffic Volume (veh/h)       | 121   | 50  | 183   | 54  | 78  | 29  | 104  | 849   | 9   | 10  | 753   | 55  |
| Future Volume (veh/h)        | 121   | 50  | 183   | 54  | 78  | 29  | 104  | 849   | 9   | 10  | 753   | 55  |
| Number                       | 7   | 4   | 14  | 3   | 8   | 18  | 5  | 2   | 12  | 1   | 6   | 16  |
| Initial Q (Qb), veh          | 0   | 0   | 0   | 0   | 0   | 0   | 0  | 0   | 0   | 0   | 0   | 0   |
| Ped-Bike Adj(A_pbT)          | 1.00  |   | 0.98  | 1.00  |   | 1.00  | 1.00   |   | 0.98  | 1.00  |   | 1.00  |
| Parking Bus, Adj             | 1.00  | 1.00  | 1.00  | 1.00  | 1.00  | 1.00  | 1.00   | 1.00  | 1.00  | 1.00  | 1.00  | 1.00  |
| Adj Sat Flow, veh/h/ln       | 1845  | 1845  | 1900  | 1827  | 1845  | 1900  | 1759   | 1843  | 1900  | 1727  | 1842  | 1900  |
| Adj Flow Rate, veh/h         | 149   | 62  | 96  | 67  | 96  | 22  | 128  | 1048  | 11  | 12  | 930   | 63  |
| Adj No. of Lanes             | 1   | 1   | 0   | 1   | 1   | 0   | 1  | 2   | 0   | 1   | 2   | 0   |
| Peak Hour Factor             | 0.81  | 0.81  | 0.81  | 0.81  | 0.81  | 0.81  | 0.81   | 0.81  | 0.81  | 0.81  | 0.81  | 0.81  |
| Percent Heavy Veh, %         | 3   | 3   | 3   | 4   | 3   | 3   | 8  | 3   | 3   | 10  | 3   | 3   |
| Cap, veh/h                   | 241   | 127   | 197   | 200   | 286   | 66  | 249  | 2326  | 24  | 18  | 1724  | 117   |
| Arrive On Green              | 0.20  | 0.20  | 0.20  | 0.20  | 0.20  | 0.20  | 0.15   | 0.66  | 0.66  | 0.01  | 0.52  | 0.52  |
| Sat Flow, veh/h              | 1254  | 646   | 1001  | 1198  | 1452  | 333   | 1675   | 3549  | 37  | 1645  | 3326  | 225   |
| Grp Volume(v), veh/h         | 149   | 0   | 158   | 67  | 0   | 118   | 128  | 517   | 542   | 12  | 489   | 504   |
| Grp Sat Flow(s),veh/h/ln     | 1254  | 0   | 1647  | 1198  | 0   | 1785  | 1675   | 1751  | 1836  | 1645  | 1750  | 1801  |
| Q Serve(g_s), s              | 12.8  | 0.0   | 9.4   | 5.8   | 0.0   | 6.3   | 7.7  | 15.9  | 15.9  | 0.8   | 20.6  | 20.6  |
| Cycle Q Clear(g_c), s        | 19.0  | 0.0   | 9.4   | 15.2  | 0.0   | 6.3   | 7.7  | 15.9  | 15.9  | 0.8   | 20.6  | 20.6  |
| Prop In Lane                 | 1.00  |   | 0.61  | 1.00  |   | 0.19  | 1.00   |   | 0.02  | 1.00  |   | 0.13  |
| Lane Grp Cap(c), veh/h       | 241   | 0   | 325   | 200   | 0   | 352   | 249  | 1148  | 1203  | 18  | 907   | 933   |
| V/C Ratio(X)                 | 0.62  | 0.00  | 0.49  | 0.34  | 0.00  | 0.34  | 0.51   | 0.45  | 0.45  | 0.65  | 0.54  | 0.54  |
| Avail Cap(c_a), veh/h        | 279   | 0   | 374   | 236   | 0   | 406   | 249  | 1148  | 1203  | 194   | 907   | 933   |
| HCM Platoon Ratio            | 1.00  | 1.00  | 1.00  | 1.00  | 1.00  | 1.00  | 1.00   | 1.00  | 1.00  | 1.00  | 1.00  | 1.00  |
| Upstream Filter(I)           | 1.00  | 0.00  | 1.00  | 1.00  | 0.00  | 1.00  | 1.00   | 1.00  | 1.00  | 1.00  | 1.00  | 1.00  |
| Uniform Delay (d), s/veh     | 46.1  | 0.0   | 39.2  | 45.9  | 0.0   | 38.0  | 43.2   | 9.3   | 9.3   | 54.2  | 17.7  | 17.7  |
| Incr Delay (d2), s/veh       | 1.7   | 0.0   | 0.4   | 0.4   | 0.0   | 0.2   | 0.8  | 1.3   | 1.2   | 13.6  | 2.3   | 2.2   |
| Initial Q Delay(d3),s/veh    | 0.0   | 0.0   | 0.0   | 0.0   | 0.0   | 0.0   | 0.0  | 0.0   | 0.0   | 0.0   | 0.0   | 0.0   |
| %ile BackOfQ(50%),veh/ln     | 4.5   | 0.0   | 4.3   | 1.9   | 0.0   | 3.1   | 3.6  | 8.0   | 8.4   | 0.4   | 10.5  | 10.8  |
| LnGrp Delay(d),s/veh         | 47.8  | 0.0   | 39.6  | 46.3  | 0.0   | 38.2  | 44.0   | 10.5  | 10.5  | 67.8  | 20.0  | 20.0  |
| LnGrp LOS                    | D   |   | D   | D   |   | D   | D  | B   | B   | E   | C   | B   |
| Approach Vol, veh/h          |   | 307   |   |   | 185   |   |  | 1187  |   |   | 1005  |   |
| Approach Delay, s/veh        |   | 43.6  |   |   | 41.1  |   |  | 14.1  |   |   | 20.6  |   |
| Approach LOS                 |   | D   |   |   | D   |   |  | B   |   |   | C   |   |
| Timer                        | 1   | 2   | 3   | 4   | 5   | 6   | 7  | 8   |   |   |   |   |
| Assigned Phs                 | 1   | 2   |   | 4   | 5   | 6   |  | 8   |   |   |   |   |
| Phs Duration (G+Y+Rc), s     | 6.2   | 77.1  |   | 26.7  | 21.3  | 62.0  |  | 26.7  |   |   |   |   |
| Change Period (Y+Rc), s      | 5.0   | 5.0   |   | 5.0   | 5.0   | 5.0   |  | 5.0   |   |   |   |   |
| Max Green Setting (Gmax), s  | 13.0  | 57.0  |   | 25.0  | 13.0  | 57.0  |  | 25.0  |   |   |   |   |
| Max Q Clear Time (g_c+I1), s | 2.8   | 17.9  |   | 21.0  | 9.7   | 22.6  |  | 17.2  |   |   |   |   |
| Green Ext Time (p_c), s      | 0.0   | 21.8  |   | 0.7   | 0.3   | 18.8  |  | 1.1   |   |   |   |   |
| <b>Intersection Summary</b>  |   |   |   |   |   |   |  |   |   |   |   |   |
| HCM 2010 Ctrl Delay          |   |   | 21.8  |   |   |   |  |   |   |   |   |   |
| HCM 2010 LOS                 |   |   | C   |   |   |   |  |   |   |   |   |   |



















HCM 2010 Signalized Intersection Summary  
9: El Dorado Street & Alpine Avenue

Stockton General Plan  
Existing AM

|                              |  |    |  |  |    |  |  |    |  |  |    |  |
|------------------------------|---|---|---|---|---|---|--|---|---|---|---|---|
| Movement                     | EBL   | EBT   | EBR   | WBL   | WBT   | WBR   | NBL  | NBT   | NBR   | SBL   | SBT   | SBR   |
| Lane Configurations          |  |   |   |  |   |  |  |   |   |  |   |  |
| Traffic Volume (veh/h)       | 48  | 423   | 48  | 125   | 328   | 191   | 85   | 590   | 75  | 215   | 821   | 39  |
| Future Volume (veh/h)        | 48  | 423   | 48  | 125   | 328   | 191   | 85   | 590   | 75  | 215   | 821   | 39  |
| Number                       | 7   | 4   | 14  | 3   | 8   | 18  | 1  | 6   | 16  | 5   | 2   | 12  |
| Initial Q (Qb), veh          | 0   | 0   | 0   | 0   | 0   | 0   | 0  | 0   | 0   | 0   | 0   | 0   |
| Ped-Bike Adj(A_pbT)          | 1.00  |   | 0.98  | 1.00  |   | 1.00  | 1.00   |   | 1.00  | 1.00  |   | 1.00  |
| Parking Bus, Adj             | 1.00  | 1.00  | 1.00  | 1.00  | 1.00  | 1.00  | 1.00   | 1.00  | 1.00  | 1.00  | 1.00  | 1.00  |
| Adj Sat Flow, veh/h/ln       | 1827  | 1843  | 1900  | 1845  | 1810  | 1845  | 1845   | 1796  | 1900  | 1845  | 1845  | 1810  |
| Adj Flow Rate, veh/h         | 56  | 498   | 48  | 147   | 386   | 54  | 100  | 694   | 79  | 253   | 966   | 19  |
| Adj No. of Lanes             | 1   | 2   | 0   | 1   | 2   | 1   | 1  | 2   | 0   | 1   | 2   | 1   |
| Peak Hour Factor             | 0.85  | 0.85  | 0.85  | 0.85  | 0.85  | 0.85  | 0.85   | 0.85  | 0.85  | 0.85  | 0.85  | 0.85  |
| Percent Heavy Veh, %         | 4   | 3   | 3   | 3   | 5   | 3   | 3  | 6   | 6   | 3   | 3   | 5   |
| Cap, veh/h                   | 72  | 572   | 55  | 175   | 812   | 370   | 125  | 1207  | 137   | 263   | 1646  | 721   |
| Arrive On Green              | 0.04  | 0.18  | 0.18  | 0.10  | 0.24  | 0.24  | 0.07   | 0.39  | 0.39  | 0.15  | 0.47  | 0.47  |
| Sat Flow, veh/h              | 1740  | 3222  | 309   | 1757  | 3438  | 1566  | 1757   | 3089  | 351   | 1757  | 3505  | 1536  |
| Grp Volume(v), veh/h         | 56  | 270   | 276   | 147   | 386   | 54  | 100  | 383   | 390   | 253   | 966   | 19  |
| Grp Sat Flow(s),veh/h/ln     | 1740  | 1751  | 1781  | 1757  | 1719  | 1566  | 1757   | 1706  | 1734  | 1757  | 1752  | 1536  |
| Q Serve(g_s), s              | 3.5   | 16.5  | 16.6  | 9.0   | 10.6  | 3.0   | 6.2  | 19.4  | 19.4  | 15.7  | 22.2  | 0.7   |
| Cycle Q Clear(g_c), s        | 3.5   | 16.5  | 16.6  | 9.0   | 10.6  | 3.0   | 6.2  | 19.4  | 19.4  | 15.7  | 22.2  | 0.7   |
| Prop In Lane                 | 1.00  |   | 0.17  | 1.00  |   | 1.00  | 1.00   |   | 0.20  | 1.00  |   | 1.00  |
| Lane Grp Cap(c), veh/h       | 72  | 311   | 316   | 175   | 812   | 370   | 125  | 667   | 678   | 263   | 1646  | 721   |
| V/C Ratio(X)                 | 0.78  | 0.87  | 0.87  | 0.84  | 0.48  | 0.15  | 0.80   | 0.57  | 0.58  | 0.96  | 0.59  | 0.03  |
| Avail Cap(c_a), veh/h        | 237   | 350   | 356   | 240   | 812   | 370   | 240  | 667   | 678   | 263   | 1646  | 721   |
| HCM Platoon Ratio            | 1.00  | 1.00  | 1.00  | 1.00  | 1.00  | 1.00  | 1.00   | 1.00  | 1.00  | 1.00  | 1.00  | 1.00  |
| Upstream Filter(I)           | 1.00  | 1.00  | 1.00  | 1.00  | 1.00  | 1.00  | 1.00   | 1.00  | 1.00  | 1.00  | 1.00  | 1.00  |
| Uniform Delay (d), s/veh     | 52.2  | 44.0  | 44.0  | 48.6  | 36.2  | 33.2  | 50.3   | 26.3  | 26.3  | 46.4  | 21.4  | 15.7  |
| Incr Delay (d2), s/veh       | 6.7   | 17.1  | 17.7  | 13.0  | 0.2   | 0.1   | 4.4  | 3.6   | 3.5   | 44.1  | 1.5   | 0.1   |
| Initial Q Delay(d3),s/veh    | 0.0   | 0.0   | 0.0   | 0.0   | 0.0   | 0.0   | 0.0  | 0.0   | 0.0   | 0.0   | 0.0   | 0.0   |
| %ile BackOfQ(50%),veh/ln     | 1.8   | 9.4   | 9.7   | 5.0   | 5.1   | 1.3   | 3.2  | 9.8   | 10.0  | 10.9  | 11.1  | 0.3   |
| LnGrp Delay(d),s/veh         | 58.9  | 61.1  | 61.7  | 61.7  | 36.3  | 33.3  | 54.7   | 29.9  | 29.9  | 90.6  | 22.9  | 15.7  |
| LnGrp LOS                    | E   | E   | E   | E   | D   | C   | D  | C   | C   | F   | C   | B   |
| Approach Vol, veh/h          |   | 602   |   |   | 587   |   |  | 873   |   |   | 1238  |   |
| Approach Delay, s/veh        |   | 61.2  |   |   | 42.4  |   |  | 32.7  |   |   | 36.6  |   |
| Approach LOS                 |   | E   |   |   | D   |   |  | C   |   |   | D   |   |
| Timer                        | 1   | 2   | 3   | 4   | 5   | 6   | 7  | 8   |   |   |   |   |
| Assigned Phs                 | 1   | 2   | 3   | 4   | 5   | 6   | 7  | 8   |   |   |   |   |
| Phs Duration (G+Y+Rc), s     | 12.8  | 56.7  | 16.0  | 24.5  | 21.5  | 48.0  | 9.5  | 31.0  |   |   |   |   |
| Change Period (Y+Rc), s      | 5.0   | 5.0   | 5.0   | 5.0   | 5.0   | 5.0   | 5.0  | 5.0   |   |   |   |   |
| Max Green Setting (Gmax), s  | 15.0  | 38.0  | 15.0  | 22.0  | 10.0  | 43.0  | 15.0   | 22.0  |   |   |   |   |
| Max Q Clear Time (g_c+I1), s | 8.2   | 24.2  | 11.0  | 18.6  | 17.7  | 21.4  | 5.5  | 12.6  |   |   |   |   |
| Green Ext Time (p_c), s      | 0.1   | 9.9   | 0.1   | 0.8   | 0.0   | 10.7  | 0.0  | 2.8   |   |   |   |   |
| <b>Intersection Summary</b>  |   |   |   |   |   |   |  |   |   |   |   |   |
| HCM 2010 Ctrl Delay          |   |   | 41.1  |   |   |   |  |   |   |   |   |   |
| HCM 2010 LOS                 |   |   | D   |   |   |   |  |   |   |   |   |   |
| <b>Notes</b>                 |   |   |   |   |   |   |  |   |   |   |   |   |























HCM 2010 Signalized Intersection Summary  
 10: Pacific Avenue & Harding Way

Stockton General Plan  
 Existing AM

|                              |  |  |  |  |  |  |  |  |  |  |  |  |
|------------------------------|---|---|---|---|---|---|--|---|---|---|---|---|
| Movement                     | EBL   | EBT   | EBR   | WBL   | WBT   | WBR   | NBL  | NBT   | NBR   | SBL   | SBT   | SBR   |
| Lane Configurations          |   |  |   |   |  |  |  |  |  |  |  |   |
| Traffic Volume (veh/h)       | 59  | 436   | 13  | 15  | 347   | 158   | 13   | 83  | 34  | 382   | 84  | 99  |
| Future Volume (veh/h)        | 59  | 436   | 13  | 15  | 347   | 158   | 13   | 83  | 34  | 382   | 84  | 99  |
| Number                       | 5   | 2   | 12  | 1   | 6   | 16  | 3  | 8   | 18  | 7   | 4   | 14  |
| Initial Q (Qb), veh          | 0   | 0   | 0   | 0   | 0   | 0   | 0  | 0   | 0   | 0   | 0   | 0   |
| Ped-Bike Adj(A_pbT)          | 0.99  |   | 0.97  | 1.00  |   | 0.96  | 1.00   |   | 0.98  | 1.00  |   | 1.00  |
| Parking Bus, Adj             | 1.00  | 1.00  | 0.88  | 1.00  | 1.00  | 1.00  | 1.00   | 1.00  | 1.00  | 1.00  | 1.00  | 1.00  |
| Adj Sat Flow, veh/h/ln       | 1900  | 1842  | 1900  | 1900  | 1828  | 1792  | 1900   | 1770  | 1845  | 1845  | 1803  | 1900  |
| Adj Flow Rate, veh/h         | 72  | 532   | 16  | 18  | 423   | 80  | 16   | 101   | 4   | 539   | 0   | 0   |
| Adj No. of Lanes             | 0   | 2   | 0   | 0   | 2   | 1   | 0  | 1   | 1   | 2   | 1   | 0   |
| Peak Hour Factor             | 0.82  | 0.82  | 0.82  | 0.82  | 0.82  | 0.82  | 0.82   | 0.82  | 0.82  | 0.82  | 0.82  | 0.82  |
| Percent Heavy Veh, %         | 3   | 3   | 3   | 4   | 4   | 6   | 8  | 8   | 3   | 3   | 11  | 11  |
| Cap, veh/h                   | 191   | 1334  | 40  | 81  | 1648  | 737   | 24   | 151   | 153   | 764   | 392   | 0   |
| Arrive On Green              | 0.51  | 0.51  | 0.51  | 0.51  | 0.51  | 0.51  | 0.10   | 0.10  | 0.10  | 0.22  | 0.00  | 0.00  |
| Sat Flow, veh/h              | 275   | 2635  | 79  | 70  | 3254  | 1456  | 240  | 1518  | 1540  | 3514  | 1803  | 0   |
| Grp Volume(v), veh/h         | 324   | 0   | 296   | 233   | 208   | 80  | 117  | 0   | 4   | 539   | 0   | 0   |
| Grp Sat Flow(s),veh/h/ln     | 1538  | 0   | 1451  | 1744  | 1580  | 1456  | 1758   | 0   | 1540  | 1757  | 1803  | 0   |
| Q Serve(g_s), s              | 2.6   | 0.0   | 10.7  | 0.0   | 6.4   | 2.4   | 5.5  | 0.0   | 0.2   | 12.1  | 0.0   | 0.0   |
| Cycle Q Clear(g_c), s        | 9.6   | 0.0   | 10.7  | 6.1   | 6.4   | 2.4   | 5.5  | 0.0   | 0.2   | 12.1  | 0.0   | 0.0   |
| Prop In Lane                 | 0.22  |   | 0.05  | 0.08  |   | 1.00  | 0.14   |   | 1.00  | 1.00  |   | 0.00  |
| Lane Grp Cap(c), veh/h       | 831   | 0   | 735   | 929   | 800   | 737   | 175  | 0   | 153   | 764   | 392   | 0   |
| V/C Ratio(X)                 | 0.39  | 0.00  | 0.40  | 0.25  | 0.26  | 0.11  | 0.67   | 0.00  | 0.03  | 0.71  | 0.00  | 0.00  |
| Avail Cap(c_a), veh/h        | 831   | 0   | 735   | 929   | 800   | 737   | 455  | 0   | 398   | 1033  | 530   | 0   |
| HCM Platoon Ratio            | 1.00  | 1.00  | 1.00  | 1.00  | 1.00  | 1.00  | 1.00   | 1.00  | 1.00  | 1.00  | 1.00  | 1.00  |
| Upstream Filter(I)           | 1.00  | 0.00  | 1.00  | 1.00  | 1.00  | 1.00  | 1.00   | 0.00  | 1.00  | 1.00  | 0.00  | 0.00  |
| Uniform Delay (d), s/veh     | 12.6  | 0.0   | 13.0  | 11.9  | 11.9  | 11.0  | 36.9   | 0.0   | 34.5  | 30.7  | 0.0   | 0.0   |
| Incr Delay (d2), s/veh       | 1.4   | 0.0   | 1.6   | 0.6   | 0.8   | 0.3   | 4.3  | 0.0   | 0.1   | 4.3   | 0.0   | 0.0   |
| Initial Q Delay(d3),s/veh    | 0.0   | 0.0   | 0.0   | 0.0   | 0.0   | 0.0   | 0.0  | 0.0   | 0.0   | 0.0   | 0.0   | 0.0   |
| %ile BackOfQ(50%),veh/ln     | 4.9   | 0.0   | 4.6   | 3.2   | 3.0   | 1.0   | 2.8  | 0.0   | 0.1   | 6.3   | 0.0   | 0.0   |
| LnGrp Delay(d),s/veh         | 14.0  | 0.0   | 14.6  | 12.5  | 12.7  | 11.3  | 41.2   | 0.0   | 34.6  | 35.1  | 0.0   | 0.0   |
| LnGrp LOS                    | B   |   | B   | B   | B   | B   | D  |   | C   | D   |   |   |
| Approach Vol, veh/h          |   | 620   |   |   | 521   |   |  | 121   |   |   | 539   |   |
| Approach Delay, s/veh        |   | 14.3  |   |   | 12.4  |   |  | 41.0  |   |   | 35.1  |   |
| Approach LOS                 |   | B   |   |   | B   |   |  | D   |   |   | D   |   |
| Timer                        | 1   | 2   | 3   | 4   | 5   | 6   | 7  | 8   |   |   |   |   |
| Assigned Phs                 |   | 2   |   | 4   |   | 6   |  | 8   |   |   |   |   |
| Phs Duration (G+Y+Rc), s     |   | 48.0  |   | 23.5  |   | 48.0  |  | 13.5  |   |   |   |   |
| Change Period (Y+Rc), s      |   | 5.0   |   | 5.0   |   | 5.0   |  | 5.0   |   |   |   |   |
| Max Green Setting (Gmax), s  |   | 23.0  |   | 25.0  |   | 23.0  |  | 22.0  |   |   |   |   |
| Max Q Clear Time (g_c+I1), s |   | 12.7  |   | 14.1  |   | 8.4   |  | 7.5   |   |   |   |   |
| Green Ext Time (p_c), s      |   | 3.6   |   | 4.0   |   | 4.3   |  | 0.5   |   |   |   |   |
| <b>Intersection Summary</b>  |   |   |   |   |   |   |  |   |   |   |   |   |
| HCM 2010 Ctrl Delay          |   |   |   | 21.8  |   |   |  |   |   |   |   |   |
| HCM 2010 LOS                 |   |   |   | C   |   |   |  |   |   |   |   |   |
| <b>Notes</b>                 |   |   |   |   |   |   |  |   |   |   |   |   |























HCM 2010 Signalized Intersection Summary  
 11: Airport Way/West Lane & Harding Way

Stockton General Plan  
 Existing AM

|                              |  |  |  |  |  |  |  |  |  |  |  |  |
|------------------------------|---|---|---|---|---|---|--|---|---|---|---|---|
| Movement                     | EBL   | EBT   | EBR   | WBL   | WBT   | WBR   | NBL  | NBT   | NBR   | SBL   | SBT   | SBR   |
| Lane Configurations          |  |  |  |  |  |   |  |  |   |  |  |  |
| Traffic Volume (veh/h)       | 198   | 372   | 104   | 30  | 597   | 70  | 114  | 554   | 27  | 90  | 583   | 210   |
| Future Volume (veh/h)        | 198   | 372   | 104   | 30  | 597   | 70  | 114  | 554   | 27  | 90  | 583   | 210   |
| Number                       | 3   | 8   | 18  | 7   | 4   | 14  | 5  | 2   | 12  | 1   | 6   | 16  |
| Initial Q (Qb), veh          | 0   | 0   | 0   | 0   | 0   | 0   | 0  | 0   | 0   | 0   | 0   | 0   |
| Ped-Bike Adj(A_pbT)          | 1.00  |   | 0.99  | 1.00  |   | 0.98  | 1.00   |   | 0.98  | 1.00  |   | 0.98  |
| Parking Bus, Adj             | 1.00  | 1.00  | 1.00  | 1.00  | 1.00  | 1.00  | 1.00   | 1.00  | 1.00  | 1.00  | 1.00  | 1.00  |
| Adj Sat Flow, veh/h/ln       | 1845  | 1845  | 1845  | 1845  | 1808  | 1900  | 1827   | 1841  | 1900  | 1792  | 1845  | 1845  |
| Adj Flow Rate, veh/h         | 241   | 454   | 59  | 37  | 728   | 80  | 139  | 676   | 31  | 110   | 711   | 154   |
| Adj No. of Lanes             | 1   | 2   | 1   | 1   | 2   | 0   | 1  | 2   | 0   | 1   | 2   | 1   |
| Peak Hour Factor             | 0.82  | 0.82  | 0.82  | 0.82  | 0.82  | 0.82  | 0.82   | 0.82  | 0.82  | 0.82  | 0.82  | 0.82  |
| Percent Heavy Veh, %         | 3   | 3   | 3   | 3   | 5   | 5   | 4  | 3   | 3   | 6   | 3   | 3   |
| Cap, veh/h                   | 271   | 1397  | 622   | 47  | 844   | 93  | 167  | 1103  | 51  | 135   | 1077  | 472   |
| Arrive On Green              | 0.15  | 0.40  | 0.40  | 0.03  | 0.27  | 0.27  | 0.10   | 0.32  | 0.32  | 0.08  | 0.31  | 0.31  |
| Sat Flow, veh/h              | 1757  | 3505  | 1560  | 1757  | 3113  | 342   | 1740   | 3404  | 156   | 1707  | 3505  | 1538  |
| Grp Volume(v), veh/h         | 241   | 454   | 59  | 37  | 401   | 407   | 139  | 347   | 360   | 110   | 711   | 154   |
| Grp Sat Flow(s),veh/h/ln     | 1757  | 1752  | 1560  | 1757  | 1717  | 1738  | 1740   | 1749  | 1811  | 1707  | 1752  | 1538  |
| Q Serve(g_s), s              | 15.7  | 10.4  | 2.8   | 2.4   | 25.9  | 26.0  | 9.2  | 19.5  | 19.5  | 7.4   | 20.6  | 9.0   |
| Cycle Q Clear(g_c), s        | 15.7  | 10.4  | 2.8   | 2.4   | 25.9  | 26.0  | 9.2  | 19.5  | 19.5  | 7.4   | 20.6  | 9.0   |
| Prop In Lane                 | 1.00  |   | 1.00  | 1.00  |   | 0.20  | 1.00   |   | 0.09  | 1.00  |   | 1.00  |
| Lane Grp Cap(c), veh/h       | 271   | 1397  | 622   | 47  | 465   | 471   | 167  | 567   | 587   | 135   | 1077  | 472   |
| V/C Ratio(X)                 | 0.89  | 0.32  | 0.09  | 0.79  | 0.86  | 0.86  | 0.83   | 0.61  | 0.61  | 0.81  | 0.66  | 0.33  |
| Avail Cap(c_a), veh/h        | 603   | 1503  | 669   | 241   | 471   | 477   | 522  | 570   | 590   | 351   | 1142  | 501   |
| HCM Platoon Ratio            | 1.00  | 1.00  | 1.00  | 1.00  | 1.00  | 1.00  | 1.00   | 1.00  | 1.00  | 1.00  | 1.00  | 1.00  |
| Upstream Filter(I)           | 1.00  | 1.00  | 1.00  | 1.00  | 1.00  | 1.00  | 1.00   | 1.00  | 1.00  | 1.00  | 1.00  | 1.00  |
| Uniform Delay (d), s/veh     | 48.3  | 24.2  | 21.9  | 56.4  | 40.4  | 40.4  | 51.8   | 33.2  | 33.2  | 52.9  | 35.1  | 31.1  |
| Incr Delay (d2), s/veh       | 4.0   | 0.5   | 0.2   | 10.4  | 17.6  | 17.6  | 4.1  | 4.1   | 4.0   | 4.4   | 2.7   | 1.4   |
| Initial Q Delay(d3),s/veh    | 0.0   | 0.0   | 0.0   | 0.0   | 0.0   | 0.0   | 0.0  | 0.0   | 0.0   | 0.0   | 0.0   | 0.0   |
| %ile BackOfQ(50%),veh/ln     | 7.9   | 5.1   | 1.2   | 1.3   | 14.5  | 14.7  | 4.6  | 10.1  | 10.4  | 3.7   | 10.4  | 4.0   |
| LnGrp Delay(d),s/veh         | 52.3  | 24.7  | 22.2  | 66.8  | 58.1  | 58.0  | 55.9   | 37.3  | 37.2  | 57.3  | 37.8  | 32.5  |
| LnGrp LOS                    | D   | C   | C   | E   | E   | E   | E  | D   | D   | E   | D   | C   |
| Approach Vol, veh/h          |   | 754   |   |   | 845   |   |  | 846   |   |   | 975   |   |
| Approach Delay, s/veh        |   | 33.3  |   |   | 58.4  |   |  | 40.3  |   |   | 39.2  |   |
| Approach LOS                 |   | C   |   |   | E   |   |  | D   |   |   | D   |   |
| Timer                        | 1   | 2   | 3   | 4   | 5   | 6   | 7  | 8   |   |   |   |   |
| Assigned Phs                 | 1   | 2   | 3   | 4   | 5   | 6   | 7  | 8   |   |   |   |   |
| Phs Duration (G+Y+Rc), s     | 14.2  | 42.8  | 23.0  | 36.6  | 16.2  | 40.8  | 8.1  | 51.5  |   |   |   |   |
| Change Period (Y+Rc), s      | 5.0   | 5.0   | 5.0   | 5.0   | 5.0   | 5.0   | 5.0  | 5.0   |   |   |   |   |
| Max Green Setting (Gmax), s  | 24.0  | 38.0  | 40.0  | 32.0  | 35.0  | 38.0  | 16.0   | 50.0  |   |   |   |   |
| Max Q Clear Time (g_c+I1), s | 9.4   | 21.5  | 17.7  | 28.0  | 11.2  | 22.6  | 4.4  | 12.4  |   |   |   |   |
| Green Ext Time (p_c), s      | 0.1   | 14.0  | 0.3   | 3.6   | 0.2   | 13.3  | 0.0  | 24.6  |   |   |   |   |
| <b>Intersection Summary</b>  |   |   |   |   |   |   |  |   |   |   |   |   |
| HCM 2010 Ctrl Delay          |   |   | 42.9  |   |   |   |  |   |   |   |   |   |
| HCM 2010 LOS                 |   |   | D   |   |   |   |  |   |   |   |   |   |

























HCM 2010 Signalized Intersection Summary  
 12: Fresno Avenue & Charter Way





















Stockton General Plan  
 Existing AM

|                              |  |  |  |  |  |  |  |  |  |  |  |  |
|------------------------------|---|---|---|---|---|---|--|---|---|---|---|---|
| Movement                     | EBL   | EBT   | EBR   | WBL   | WBT   | WBR   | NBL  | NBT   | NBR   | SBL   | SBT   | SBR   |
| Lane Configurations          |  |  |   |  |  |  |  |  |   |  |  |  |
| Traffic Volume (veh/h)       | 89  | 308   | 17  | 123   | 411   | 36  | 32   | 158   | 165   | 76  | 93  | 90  |
| Future Volume (veh/h)        | 89  | 308   | 17  | 123   | 411   | 36  | 32   | 158   | 165   | 76  | 93  | 90  |
| Number                       | 5   | 2   | 12  | 1   | 6   | 16  | 3  | 8   | 18  | 7   | 4   | 14  |
| Initial Q (Qb), veh          | 0   | 0   | 0   | 0   | 0   | 0   | 0  | 0   | 0   | 0   | 0   | 0   |
| Ped-Bike Adj(A_pbT)          | 1.00  |   | 1.00  | 1.00  |   | 1.00  | 1.00   |   | 1.00  | 1.00  |   | 1.00  |
| Parking Bus, Adj             | 1.00  | 1.00  | 1.00  | 1.00  | 1.00  | 1.00  | 1.00   | 1.00  | 1.00  | 1.00  | 1.00  | 1.00  |
| Adj Sat Flow, veh/h/ln       | 1624  | 1689  | 1900  | 1845  | 1638  | 1397  | 1743   | 1827  | 1900  | 1377  | 1810  | 1681  |
| Adj Flow Rate, veh/h         | 103   | 358   | 0   | 143   | 478   | 14  | 37   | 184   | 166   | 88  | 108   | 27  |
| Adj No. of Lanes             | 1   | 1   | 0   | 1   | 1   | 1   | 1  | 1   | 0   | 1   | 1   | 1   |
| Peak Hour Factor             | 0.86  | 0.86  | 0.86  | 0.86  | 0.86  | 0.86  | 0.86   | 0.86  | 0.86  | 0.86  | 0.86  | 0.86  |
| Percent Heavy Veh, %         | 17  | 13  | 13  | 3   | 16  | 36  | 9  | 3   | 3   | 38  | 5   | 13  |
| Cap, veh/h                   | 214   | 611   | 0   | 200   | 518   | 375   | 120  | 188   | 170   | 150   | 460   | 364   |
| Arrive On Green              | 0.14  | 0.36  | 0.00  | 0.11  | 0.32  | 0.32  | 0.07   | 0.21  | 0.21  | 0.11  | 0.25  | 0.25  |
| Sat Flow, veh/h              | 1547  | 1689  | 0   | 1757  | 1638  | 1188  | 1660   | 886   | 799   | 1311  | 1810  | 1429  |
| Grp Volume(v), veh/h         | 103   | 358   | 0   | 143   | 478   | 14  | 37   | 0   | 350   | 88  | 108   | 27  |
| Grp Sat Flow(s),veh/h/ln     | 1547  | 1689  | 0   | 1757  | 1638  | 1188  | 1660   | 0   | 1685  | 1311  | 1810  | 1429  |
| Q Serve(g_s), s              | 5.8   | 16.2  | 0.0   | 7.4   | 26.6  | 0.5   | 2.0  | 0.0   | 19.5  | 6.0   | 4.5   | 0.9   |
| Cycle Q Clear(g_c), s        | 5.8   | 16.2  | 0.0   | 7.4   | 26.6  | 0.5   | 2.0  | 0.0   | 19.5  | 6.0   | 4.5   | 0.9   |
| Prop In Lane                 | 1.00  |   | 0.00  | 1.00  |   | 1.00  | 1.00   |   | 0.47  | 1.00  |   | 1.00  |
| Lane Grp Cap(c), veh/h       | 214   | 611   | 0   | 200   | 518   | 375   | 120  | 0   | 358   | 150   | 460   | 364   |
| V/C Ratio(X)                 | 0.48  | 0.59  | 0.00  | 0.71  | 0.92  | 0.04  | 0.31   | 0.00  | 0.98  | 0.59  | 0.23  | 0.07  |
| Avail Cap(c_a), veh/h        | 492   | 1165  | 0   | 373   | 869   | 630   | 264  | 0   | 358   | 209   | 460   | 364   |
| HCM Platoon Ratio            | 1.00  | 1.00  | 1.00  | 1.00  | 1.00  | 1.00  | 1.00   | 1.00  | 1.00  | 1.00  | 1.00  | 1.00  |
| Upstream Filter(I)           | 1.00  | 1.00  | 0.00  | 1.00  | 1.00  | 1.00  | 1.00   | 0.00  | 1.00  | 1.00  | 1.00  | 1.00  |
| Uniform Delay (d), s/veh     | 37.5  | 24.4  | 0.0   | 40.3  | 31.1  | 10.2  | 41.5   | 0.0   | 36.9  | 39.6  | 27.9  | 11.7  |
| Incr Delay (d2), s/veh       | 1.2   | 0.3   | 0.0   | 3.5   | 6.1   | 0.0   | 1.1  | 0.0   | 41.7  | 2.7   | 0.3   | 0.1   |
| Initial Q Delay(d3),s/veh    | 0.0   | 0.0   | 0.0   | 0.0   | 0.0   | 0.0   | 0.0  | 0.0   | 0.0   | 0.0   | 0.0   | 0.0   |
| %ile BackOfQ(50%),veh/ln     | 2.5   | 7.6   | 0.0   | 3.8   | 12.8  | 0.2   | 1.0  | 0.0   | 13.2  | 2.3   | 2.3   | 0.5   |
| LnGrp Delay(d),s/veh         | 38.7  | 24.7  | 0.0   | 43.8  | 37.3  | 10.2  | 42.5   | 0.0   | 78.6  | 42.3  | 28.2  | 11.9  |
| LnGrp LOS                    | D   | C   |   | D   | D   | B   | D  |   | E   | D   | C   | B   |
| Approach Vol, veh/h          |   | 461   |   |   | 635   |   |  | 387   |   |   | 223   |   |
| Approach Delay, s/veh        |   | 27.8  |   |   | 38.1  |   |  | 75.2  |   |   | 31.8  |   |
| Approach LOS                 |   | C   |   |   | D   |   |  | E   |   |   | C   |   |
| Timer                        | 1   | 2   | 3   | 4   | 5   | 6   | 7  | 8   |   |   |   |   |
| Assigned Phs                 | 1   | 2   | 3   | 4   | 5   | 6   | 7  | 8   |   |   |   |   |
| Phs Duration (G+Y+Rc), s     | 14.7  | 40.1  | 10.8  | 28.6  | 19.1  | 35.8  | 14.8   | 24.6  |   |   |   |   |
| Change Period (Y+Rc), s      | 4.0   | 6.0   | 4.0   | 4.6   | 6.0   | * 6   | 4.0  | 4.6   |   |   |   |   |
| Max Green Setting (Gmax), s  | 20.0  | 65.0  | 15.0  | 20.0  | 30.0  | * 50  | 15.0   | 20.0  |   |   |   |   |
| Max Q Clear Time (g_c+I1), s | 9.4   | 18.2  | 4.0   | 6.5   | 7.8   | 28.6  | 8.0  | 21.5  |   |   |   |   |
| Green Ext Time (p_c), s      | 0.2   | 1.4   | 0.0   | 2.8   | 1.4   | 1.2   | 0.1  | 0.0   |   |   |   |   |
| <b>Intersection Summary</b>  |   |   |   |   |   |   |  |   |   |   |   |   |
| HCM 2010 Ctrl Delay          |   |   | 42.9  |   |   |   |  |   |   |   |   |   |
| HCM 2010 LOS                 |   |   | D   |   |   |   |  |   |   |   |   |   |
| <b>Notes</b>                 |   |   |   |   |   |   |  |   |   |   |   |   |

HCM 2010 Signalized Intersection Summary  
 13: Airport Way & Dr Martin Luther King Jr Boulevard

Stockton General Plan  
 Existing AM





















|                              |  |  |  |  |  |  |  |  |  |  |  |  |
|------------------------------|---|---|---|---|---|---|--|---|---|---|---|---|
| Movement                     | EBL   | EBT   | EBR   | WBL   | WBT   | WBR   | NBL  | NBT   | NBR   | SBL   | SBT   | SBR   |
| Lane Configurations          |  |  |  |  |  |  |  |  |  |  |  |  |
| Traffic Volume (veh/h)       | 53  | 351   | 355   | 222   | 349   | 56  | 322  | 437   | 164   | 76  | 349   | 80  |
| Future Volume (veh/h)        | 53  | 351   | 355   | 222   | 349   | 56  | 322  | 437   | 164   | 76  | 349   | 80  |
| Number                       | 5   | 2   | 12  | 1   | 6   | 16  | 7  | 4   | 14  | 3   | 8   | 18  |
| Initial Q (Qb), veh          | 0   | 0   | 0   | 0   | 0   | 0   | 0  | 0   | 0   | 0   | 0   | 0   |
| Ped-Bike Adj(A_pbT)          | 1.00  |   | 1.00  | 1.00  |   | 1.00  | 1.00   |   | 1.00  | 1.00  |   | 0.98  |
| Parking Bus, Adj             | 1.00  | 1.00  | 1.00  | 1.00  | 1.00  | 1.00  | 1.00   | 1.00  | 1.00  | 1.00  | 1.00  | 1.00  |
| Adj Sat Flow, veh/h/ln       | 1827  | 1776  | 1810  | 1743  | 1759  | 1810  | 1776   | 1840  | 1900  | 1827  | 1810  | 1845  |
| Adj Flow Rate, veh/h         | 55  | 366   | 101   | 231   | 364   | 21  | 335  | 455   | 0   | 79  | 364   | 19  |
| Adj No. of Lanes             | 2   | 2   | 1   | 2   | 2   | 1   | 2  | 2   | 0   | 2   | 2   | 1   |
| Peak Hour Factor             | 0.96  | 0.96  | 0.96  | 0.96  | 0.96  | 0.96  | 0.96   | 0.96  | 0.96  | 0.96  | 0.96  | 0.96  |
| Percent Heavy Veh, %         | 4   | 7   | 5   | 9   | 8   | 5   | 7  | 3   | 3   | 4   | 5   | 3   |
| Cap, veh/h                   | 120   | 970   | 442   | 317   | 1171  | 538   | 430  | 1121  | 0   | 140   | 795   | 357   |
| Arrive On Green              | 0.04  | 0.29  | 0.29  | 0.10  | 0.35  | 0.35  | 0.13   | 0.32  | 0.00  | 0.04  | 0.23  | 0.23  |
| Sat Flow, veh/h              | 3375  | 3374  | 1536  | 3221  | 3343  | 1534  | 3281   | 3588  | 0   | 3375  | 3438  | 1544  |
| Grp Volume(v), veh/h         | 55  | 366   | 101   | 231   | 364   | 21  | 335  | 455   | 0   | 79  | 364   | 19  |
| Grp Sat Flow(s),veh/h/ln     | 1688  | 1687  | 1536  | 1610  | 1671  | 1534  | 1640   | 1748  | 0   | 1688  | 1719  | 1544  |
| Q Serve(g_s), s              | 1.3   | 6.9   | 4.0   | 5.5   | 6.3   | 0.7   | 7.8  | 8.1   | 0.0   | 1.8   | 7.2   | 0.8   |
| Cycle Q Clear(g_c), s        | 1.3   | 6.9   | 4.0   | 5.5   | 6.3   | 0.7   | 7.8  | 8.1   | 0.0   | 1.8   | 7.2   | 0.8   |
| Prop In Lane                 | 1.00  |   | 1.00  | 1.00  |   | 1.00  | 1.00   |   | 0.00  | 1.00  |   | 1.00  |
| Lane Grp Cap(c), veh/h       | 120   | 970   | 442   | 317   | 1171  | 538   | 430  | 1121  | 0   | 140   | 795   | 357   |
| V/C Ratio(X)                 | 0.46  | 0.38  | 0.23  | 0.73  | 0.31  | 0.04  | 0.78   | 0.41  | 0.00  | 0.56  | 0.46  | 0.05  |
| Avail Cap(c_a), veh/h        | 850   | 1700  | 774   | 811   | 1263  | 580   | 1240   | 1321  | 0   | 850   | 1083  | 486   |
| HCM Platoon Ratio            | 1.00  | 1.00  | 1.00  | 1.00  | 1.00  | 1.00  | 1.00   | 1.00  | 1.00  | 1.00  | 1.00  | 1.00  |
| Upstream Filter(I)           | 1.00  | 1.00  | 1.00  | 1.00  | 1.00  | 1.00  | 1.00   | 1.00  | 0.00  | 1.00  | 1.00  | 1.00  |
| Uniform Delay (d), s/veh     | 37.5  | 22.6  | 21.6  | 34.8  | 18.8  | 17.0  | 33.4   | 21.1  | 0.0   | 37.3  | 26.2  | 23.8  |
| Incr Delay (d2), s/veh       | 1.0   | 0.9   | 0.9   | 1.2   | 0.5   | 0.1   | 1.2  | 0.9   | 0.0   | 1.3   | 1.5   | 0.2   |
| Initial Q Delay(d3),s/veh    | 0.0   | 0.0   | 0.0   | 0.0   | 0.0   | 0.0   | 0.0  | 0.0   | 0.0   | 0.0   | 0.0   | 0.0   |
| %ile BackOfQ(50%),veh/ln     | 0.6   | 3.3   | 1.8   | 2.5   | 3.0   | 0.3   | 3.6  | 4.0   | 0.0   | 0.9   | 3.6   | 0.3   |
| LnGrp Delay(d),s/veh         | 38.6  | 23.5  | 22.5  | 36.0  | 19.3  | 17.1  | 34.6   | 21.9  | 0.0   | 38.7  | 27.7  | 24.0  |
| LnGrp LOS                    | D   | C   | C   | D   | B   | B   | C  | C   |   | D   | C   | C   |
| Approach Vol, veh/h          |   | 522   |   |   | 616   |   |  | 790   |   |   | 462   |   |
| Approach Delay, s/veh        |   | 24.9  |   |   | 25.5  |   |  | 27.3  |   |   | 29.4  |   |
| Approach LOS                 |   | C   |   |   | C   |   |  | C   |   |   | C   |   |
| Timer                        | 1   | 2   | 3   | 4   | 5   | 6   | 7  | 8   |   |   |   |   |
| Assigned Phs                 | 1   | 2   | 3   | 4   | 5   | 6   | 7  | 8   |   |   |   |   |
| Phs Duration (G+Y+Rc), s     | 12.8  | 27.8  | 8.3   | 30.5  | 7.8   | 32.8  | 15.4   | 23.4  |   |   |   |   |
| Change Period (Y+Rc), s      | 5.0   | 5.0   | 5.0   | 5.0   | 5.0   | 5.0   | 5.0  | 5.0   |   |   |   |   |
| Max Green Setting (Gmax), s  | 20.0  | 40.0  | 20.0  | 30.0  | 20.0  | 30.0  | 30.0   | 25.0  |   |   |   |   |
| Max Q Clear Time (g_c+I1), s | 7.5   | 8.9   | 3.8   | 10.1  | 3.3   | 8.3   | 9.8  | 9.2   |   |   |   |   |
| Green Ext Time (p_c), s      | 0.3   | 13.8  | 0.1   | 10.6  | 0.1   | 11.2  | 0.6  | 9.1   |   |   |   |   |
| <b>Intersection Summary</b>  |   |   |   |   |   |   |  |   |   |   |   |   |
| HCM 2010 Ctrl Delay          |   |   | 26.7  |   |   |   |  |   |   |   |   |   |
| HCM 2010 LOS                 |   |   | C   |   |   |   |  |   |   |   |   |   |
| <b>Notes</b>                 |   |   |   |   |   |   |  |   |   |   |   |   |

|                              |  |  |  |  |  |  |   |  |  |  |  |  |
|------------------------------|---|---|---|---|---|---|---|---|---|---|---|---|
| Movement                     | EBL   | EBT   | EBR   | WBL   | WBT   | WBR   | NBL   | NBT   | NBR   | SBL   | SBT   | SBR   |
| Lane Configurations          |  |  |  |  |  |   |  |  |   |  |  |   |
| Traffic Volume (veh/h)       | 42  | 232   | 345   | 74  | 343   | 31  | 383   | 45  | 68  | 11  | 10  | 16  |
| Future Volume (veh/h)        | 42  | 232   | 345   | 74  | 343   | 31  | 383   | 45  | 68  | 11  | 10  | 16  |
| Number                       | 5   | 2   | 12  | 1   | 6   | 16  | 3   | 8   | 18  | 7   | 4   | 14  |
| Initial Q (Qb), veh          | 0   | 0   | 0   | 0   | 0   | 0   | 0   | 0   | 0   | 0   | 0   | 0   |
| Ped-Bike Adj(A_pbT)          | 1.00  |   | 1.00  | 1.00  |   | 1.00  | 1.00  |   | 1.00  | 1.00  |   | 1.00  |
| Parking Bus, Adj             | 1.00  | 1.00  | 1.00  | 1.00  | 1.00  | 1.00  | 1.00  | 1.00  | 1.00  | 1.00  | 1.00  | 1.00  |
| Adj Sat Flow, veh/h/ln       | 1810  | 1759  | 1727  | 1827  | 1830  | 1900  | 1810  | 1786  | 1900  | 1397  | 1409  | 1900  |
| Adj Flow Rate, veh/h         | 46  | 252   | 0   | 80  | 373   | 0   | 451   | 0   | 0   | 12  | 12  | 0   |
| Adj No. of Lanes             | 1   | 2   | 1   | 1   | 2   | 0   | 2   | 1   | 0   | 1   | 1   | 0   |
| Peak Hour Factor             | 0.92  | 0.92  | 0.92  | 0.92  | 0.92  | 0.92  | 0.92  | 0.92  | 0.92  | 0.92  | 0.92  | 0.92  |
| Percent Heavy Veh, %         | 5   | 8   | 10  | 4   | 3   | 3   | 5   | 11  | 11  | 36  | 50  | 50  |
| Cap, veh/h                   | 65  | 1006  | 442   | 101   | 1118  | 0   | 618   | 320   | 0   | 30  | 32  | 0   |
| Arrive On Green              | 0.04  | 0.30  | 0.00  | 0.06  | 0.32  | 0.00  | 0.18  | 0.00  | 0.00  | 0.02  | 0.02  | 0.00  |
| Sat Flow, veh/h              | 1723  | 3343  | 1468  | 1740  | 3568  | 0   | 3447  | 1786  | 0   | 1331  | 1409  | 0   |
| Grp Volume(v), veh/h         | 46  | 252   | 0   | 80  | 373   | 0   | 451   | 0   | 0   | 12  | 12  | 0   |
| Grp Sat Flow(s),veh/h/ln     | 1723  | 1671  | 1468  | 1740  | 1738  | 0   | 1723  | 1786  | 0   | 1331  | 1409  | 0   |
| Q Serve(g_s), s              | 1.3   | 2.9   | 0.0   | 2.3   | 4.1   | 0.0   | 6.2   | 0.0   | 0.0   | 0.4   | 0.4   | 0.0   |
| Cycle Q Clear(g_c), s        | 1.3   | 2.9   | 0.0   | 2.3   | 4.1   | 0.0   | 6.2   | 0.0   | 0.0   | 0.4   | 0.4   | 0.0   |
| Prop In Lane                 | 1.00  |   | 1.00  | 1.00  |   | 0.00  | 1.00  |   | 0.00  | 1.00  |   | 0.00  |
| Lane Grp Cap(c), veh/h       | 65  | 1006  | 442   | 101   | 1118  | 0   | 618   | 320   | 0   | 30  | 32  | 0   |
| V/C Ratio(X)                 | 0.71  | 0.25  | 0.00  | 0.79  | 0.33  | 0.00  | 0.73  | 0.00  | 0.00  | 0.40  | 0.38  | 0.00  |
| Avail Cap(c_a), veh/h        | 825   | 2667  | 1171  | 868   | 2774  | 0   | 2062  | 1068  | 0   | 663   | 702   | 0   |
| HCM Platoon Ratio            | 1.00  | 1.00  | 1.00  | 1.00  | 1.00  | 1.00  | 1.00  | 1.00  | 1.00  | 1.00  | 1.00  | 1.00  |
| Upstream Filter(I)           | 1.00  | 1.00  | 0.00  | 1.00  | 1.00  | 0.00  | 1.00  | 0.00  | 0.00  | 1.00  | 1.00  | 0.00  |
| Uniform Delay (d), s/veh     | 23.9  | 13.2  | 0.0   | 23.3  | 12.9  | 0.0   | 19.4  | 0.0   | 0.0   | 24.2  | 24.2  | 0.0   |
| Incr Delay (d2), s/veh       | 5.2   | 0.5   | 0.0   | 5.1   | 0.6   | 0.0   | 0.6   | 0.0   | 0.0   | 3.1   | 2.7   | 0.0   |
| Initial Q Delay(d3),s/veh    | 0.0   | 0.0   | 0.0   | 0.0   | 0.0   | 0.0   | 0.0   | 0.0   | 0.0   | 0.0   | 0.0   | 0.0   |
| %ile BackOfQ(50%),veh/ln     | 0.7   | 1.4   | 0.0   | 1.2   | 2.1   | 0.0   | 3.0   | 0.0   | 0.0   | 0.2   | 0.2   | 0.0   |
| LnGrp Delay(d),s/veh         | 29.0  | 13.7  | 0.0   | 28.4  | 13.6  | 0.0   | 20.1  | 0.0   | 0.0   | 27.3  | 26.8  | 0.0   |
| LnGrp LOS                    | C   | B   |   | C   | B   |   | C   |   |   | C   | C   |   |
| Approach Vol, veh/h          |   | 298   |   |   | 453   |   |   | 451   |   |   | 24  |   |
| Approach Delay, s/veh        |   | 16.1  |   |   | 16.2  |   |   | 20.1  |   |   | 27.1  |   |
| Approach LOS                 |   | B   |   |   | B   |   |   | C   |   |   | C   |   |
| Timer                        | 1   | 2   | 3   | 4   | 5   | 6   | 7   | 8   |   |   |   |   |
| Assigned Phs                 | 1   | 2   |   | 4   | 5   | 6   |   | 8   |   |   |   |   |
| Phs Duration (G+Y+Rc), s     | 7.9   | 21.1  |   | 6.1   | 6.9   | 22.1  |   | 15.0  |   |   |   |   |
| Change Period (Y+Rc), s      | 5.0   | 6.0   |   | 5.0   | 5.0   | 6.0   |   | 6.0   |   |   |   |   |
| Max Green Setting (Gmax), s  | 25.0  | 40.0  |   | 25.0  | 24.0  | 40.0  |   | 30.0  |   |   |   |   |
| Max Q Clear Time (g_c+I1), s | 4.3   | 4.9   |   | 2.4   | 3.3   | 6.1   |   | 8.2   |   |   |   |   |
| Green Ext Time (p_c), s      | 0.1   | 10.3  |   | 0.0   | 0.0   | 10.1  |   | 0.8   |   |   |   |   |
| <b>Intersection Summary</b>  |   |   |   |   |   |   |   |   |   |   |   |   |
| HCM 2010 Ctrl Delay          |   |   | 17.8  |   |   |   |   |   |   |   |   |   |
| HCM 2010 LOS                 |   |   | B   |   |   |   |   |   |   |   |   |   |
| <b>Notes</b>                 |   |   |   |   |   |   |   |   |   |   |   |   |

























HCM 2010 Signalized Intersection Summary  
 15: Mariposa Road & Stagecoach Road

Stockton General Plan  
 Existing AM

|                              |  |  |  |  |  |  |  |  |  |  |  |  |
|------------------------------|---|---|---|---|---|---|--|---|---|---|---|---|
| Movement                     | EBL   | EBT   | EBR   | WBL   | WBT   | WBR   | NBL  | NBT   | NBR   | SBL   | SBT   | SBR   |
| Lane Configurations          |  |  |   |  |  |  |  |  |   |   |  |  |
| Traffic Volume (veh/h)       | 4   | 0   | 2   | 55  | 0   | 102   | 0  | 427   | 57  | 144   | 301   | 4   |
| Future Volume (veh/h)        | 4   | 0   | 2   | 55  | 0   | 102   | 0  | 427   | 57  | 144   | 301   | 4   |
| Number                       | 5   | 2   | 12  | 1   | 6   | 16  | 3  | 8   | 18  | 7   | 4   | 14  |
| Initial Q (Qb), veh          | 0   | 0   | 0   | 0   | 0   | 0   | 0  | 0   | 0   | 0   | 0   | 0   |
| Ped-Bike Adj(A_pbT)          | 1.00  |   | 1.00  | 1.00  |   | 1.00  | 1.00   |   | 1.00  | 1.00  |   | 1.00  |
| Parking Bus, Adj             | 1.00  | 1.00  | 1.00  | 1.00  | 1.00  | 1.00  | 1.00   | 1.00  | 1.00  | 1.00  | 1.00  | 1.00  |
| Adj Sat Flow, veh/h/ln       | 1520  | 1267  | 1900  | 1520  | 1845  | 1508  | 1900   | 1629  | 1900  | 1900  | 1605  | 1845  |
| Adj Flow Rate, veh/h         | 4   | 0   | 0   | 61  | 0   | 21  | 0  | 474   | 61  | 160   | 334   | 2   |
| Adj No. of Lanes             | 1   | 2   | 0   | 1   | 2   | 1   | 0  | 1   | 0   | 0   | 1   | 1   |
| Peak Hour Factor             | 0.90  | 0.90  | 0.90  | 0.90  | 0.90  | 0.90  | 0.90   | 0.90  | 0.90  | 0.90  | 0.90  | 0.90  |
| Percent Heavy Veh, %         | 25  | 3   | 3   | 25  | 3   | 26  | 17   | 17  | 17  | 19  | 19  | 3   |
| Cap, veh/h                   | 16  | 4   | 0   | 160   | 262   | 96  | 0  | 907   | 117   | 261   | 486   | 1005  |
| Arrive On Green              | 0.01  | 0.00  | 0.00  | 0.11  | 0.00  | 0.07  | 0.00   | 0.64  | 0.64  | 0.64  | 0.64  | 0.64  |
| Sat Flow, veh/h              | 1448  | 2470  | 0   | 1448  | 3505  | 1282  | 0  | 1415  | 182   | 272   | 758   | 1567  |
| Grp Volume(v), veh/h         | 4   | 0   | 0   | 61  | 0   | 21  | 0  | 0   | 535   | 494   | 0   | 2   |
| Grp Sat Flow(s),veh/h/ln     | 1448  | 1203  | 0   | 1448  | 1752  | 1282  | 0  | 0   | 1597  | 1030  | 0   | 1567  |
| Q Serve(g_s), s              | 0.2   | 0.0   | 0.0   | 2.2   | 0.0   | 0.8   | 0.0  | 0.0   | 9.9   | 11.8  | 0.0   | 0.0   |
| Cycle Q Clear(g_c), s        | 0.2   | 0.0   | 0.0   | 2.2   | 0.0   | 0.8   | 0.0  | 0.0   | 9.9   | 21.7  | 0.0   | 0.0   |
| Prop In Lane                 | 1.00  |   | 0.00  | 1.00  |   | 1.00  | 0.00   |   | 0.11  | 0.32  |   | 1.00  |
| Lane Grp Cap(c), veh/h       | 16  | 4   | 0   | 160   | 262   | 96  | 0  | 0   | 1024  | 747   | 0   | 1005  |
| V/C Ratio(X)                 | 0.26  | 0.00  | 0.00  | 0.38  | 0.00  | 0.22  | 0.00   | 0.00  | 0.52  | 0.66  | 0.00  | 0.00  |
| Avail Cap(c_a), veh/h        | 791   | 2191  | 0   | 791   | 3190  | 1167  | 0  | 0   | 1453  | 1062  | 0   | 1427  |
| HCM Platoon Ratio            | 1.00  | 1.00  | 1.00  | 1.00  | 1.00  | 1.00  | 1.00   | 1.00  | 1.00  | 1.00  | 1.00  | 1.00  |
| Upstream Filter(I)           | 1.00  | 0.00  | 0.00  | 1.00  | 0.00  | 1.00  | 0.00   | 0.00  | 1.00  | 1.00  | 0.00  | 1.00  |
| Uniform Delay (d), s/veh     | 27.0  | 0.0   | 0.0   | 22.7  | 0.0   | 23.9  | 0.0  | 0.0   | 5.3   | 7.8   | 0.0   | 3.5   |
| Incr Delay (d2), s/veh       | 11.8  | 0.0   | 0.0   | 2.1   | 0.0   | 2.4   | 0.0  | 0.0   | 0.6   | 1.4   | 0.0   | 0.0   |
| Initial Q Delay(d3),s/veh    | 0.0   | 0.0   | 0.0   | 0.0   | 0.0   | 0.0   | 0.0  | 0.0   | 0.0   | 0.0   | 0.0   | 0.0   |
| %ile BackOfQ(50%),veh/ln     | 0.1   | 0.0   | 0.0   | 1.0   | 0.0   | 0.4   | 0.0  | 0.0   | 4.5   | 5.8   | 0.0   | 0.0   |
| LnGrp Delay(d),s/veh         | 38.8  | 0.0   | 0.0   | 24.8  | 0.0   | 26.3  | 0.0  | 0.0   | 5.9   | 9.2   | 0.0   | 3.5   |
| LnGrp LOS                    | D   |   |   | C   |   | C   |  |   | A   | A   |   | A   |
| Approach Vol, veh/h          |   | 4   |   |   | 82  |   |  | 535   |   |   | 496   |   |
| Approach Delay, s/veh        |   | 38.8  |   |   | 25.2  |   |  | 5.9   |   |   | 9.2   |   |
| Approach LOS                 |   | D   |   |   | C   |   |  | A   |   |   | A   |   |
| Timer                        | 1   | 2   | 3   | 4   | 5   | 6   | 7  | 8   |   |   |   |   |
| Assigned Phs                 | 1   | 2   |   | 4   | 5   | 6   |  | 8   |   |   |   |   |
| Phs Duration (G+Y+Rc), s     | 11.1  | 3.6   |   | 40.2  | 5.6   | 9.1   |  | 40.2  |   |   |   |   |
| Change Period (Y+Rc), s      | 5.0   | 5.0   |   | 5.0   | 5.0   | 5.0   |  | 5.0   |   |   |   |   |
| Max Green Setting (Gmax), s  | 30.0  | 50.0  |   | 50.0  | 30.0  | 50.0  |  | 50.0  |   |   |   |   |
| Max Q Clear Time (g_c+I1), s | 4.2   | 0.0   |   | 23.7  | 2.2   | 2.8   |  | 11.9  |   |   |   |   |
| Green Ext Time (p_c), s      | 0.2   | 0.0   |   | 11.5  | 0.0   | 0.1   |  | 13.5  |   |   |   |   |
| <b>Intersection Summary</b>  |   |   |   |   |   |   |  |   |   |   |   |   |
| HCM 2010 Ctrl Delay          |   |   |   | 8.9   |   |   |  |   |   |   |   |   |
| HCM 2010 LOS                 |   |   |   | A   |   |   |  |   |   |   |   |   |





















HCM 2010 Signalized Intersection Summary  
 16: McDougald Boulevard & Carolyn Weston Boulevard

Stockton General Plan  
 Existing AM

|                              |  |  |  |  |  |  |   |  |  |  |  |  |
|------------------------------|---|---|---|---|---|---|---|---|---|---|---|---|
| Movement                     | EBL   | EBT   | EBR   | WBL   | WBT   | WBR   | NBL   | NBT   | NBR   | SBL   | SBT   | SBR   |
| Lane Configurations          |  |  |   |  |  |   |  |  |  |  |  |  |
| Traffic Volume (veh/h)       | 1   | 702   | 2   | 51  | 230   | 12  | 3   | 1   | 150   | 24  | 2   | 2   |
| Future Volume (veh/h)        | 1   | 702   | 2   | 51  | 230   | 12  | 3   | 1   | 150   | 24  | 2   | 2   |
| Number                       | 5   | 2   | 12  | 1   | 6   | 16  | 3   | 8   | 18  | 7   | 4   | 14  |
| Initial Q (Qb), veh          | 0   | 0   | 0   | 0   | 0   | 0   | 0   | 0   | 0   | 0   | 0   | 0   |
| Ped-Bike Adj(A_pbT)          | 1.00  |   | 1.00  | 1.00  |   | 1.00  | 1.00  |   | 1.00  | 1.00  |   | 1.00  |
| Parking Bus, Adj             | 1.00  | 1.00  | 1.00  | 1.00  | 1.00  | 1.00  | 1.00  | 1.00  | 1.00  | 1.00  | 1.00  | 1.00  |
| Adj Sat Flow, veh/h/ln       | 1845  | 1845  | 1900  | 1827  | 1783  | 1900  | 1845  | 1845  | 1845  | 1759  | 1502  | 1900  |
| Adj Flow Rate, veh/h         | 1   | 836   | 2   | 61  | 274   | 13  | 4   | 1   | 19  | 29  | 2   | 0   |
| Adj No. of Lanes             | 1   | 2   | 0   | 1   | 2   | 0   | 1   | 1   | 1   | 1   | 1   | 0   |
| Peak Hour Factor             | 0.84  | 0.84  | 0.84  | 0.84  | 0.84  | 0.84  | 0.84  | 0.84  | 0.84  | 0.84  | 0.84  | 0.84  |
| Percent Heavy Veh, %         | 3   | 3   | 3   | 4   | 6   | 6   | 3   | 3   | 3   | 8   | 50  | 50  |
| Cap, veh/h                   | 3   | 1963  | 5   | 76  | 1944  | 92  | 8   | 41  | 34  | 44  | 66  | 0   |
| Arrive On Green              | 0.00  | 0.55  | 0.55  | 0.04  | 0.59  | 0.59  | 0.00  | 0.02  | 0.02  | 0.03  | 0.04  | 0.00  |
| Sat Flow, veh/h              | 1757  | 3587  | 9   | 1740  | 3294  | 156   | 1757  | 1845  | 1561  | 1675  | 1502  | 0   |
| Grp Volume(v), veh/h         | 1   | 408   | 430   | 61  | 140   | 147   | 4   | 1   | 19  | 29  | 2   | 0   |
| Grp Sat Flow(s),veh/h/ln     | 1757  | 1752  | 1843  | 1740  | 1694  | 1756  | 1757  | 1845  | 1561  | 1675  | 1502  | 0   |
| Q Serve(g_s), s              | 0.0   | 7.6   | 7.6   | 1.9   | 2.1   | 2.1   | 0.1   | 0.0   | 0.7   | 1.0   | 0.1   | 0.0   |
| Cycle Q Clear(g_c), s        | 0.0   | 7.6   | 7.6   | 1.9   | 2.1   | 2.1   | 0.1   | 0.0   | 0.7   | 1.0   | 0.1   | 0.0   |
| Prop In Lane                 | 1.00  |   | 0.00  | 1.00  |   | 0.09  | 1.00  |   | 1.00  | 1.00  |   | 0.00  |
| Lane Grp Cap(c), veh/h       | 3   | 959   | 1008  | 76  | 1000  | 1036  | 8   | 41  | 34  | 44  | 66  | 0   |
| V/C Ratio(X)                 | 0.32  | 0.43  | 0.43  | 0.80  | 0.14  | 0.14  | 0.53  | 0.02  | 0.55  | 0.67  | 0.03  | 0.00  |
| Avail Cap(c_a), veh/h        | 951   | 1518  | 1596  | 942   | 1467  | 1520  | 951   | 998   | 845   | 907   | 813   | 0   |
| HCM Platoon Ratio            | 1.00  | 1.00  | 1.00  | 1.00  | 1.00  | 1.00  | 1.00  | 1.00  | 1.00  | 1.00  | 1.00  | 1.00  |
| Upstream Filter(I)           | 1.00  | 1.00  | 1.00  | 1.00  | 1.00  | 1.00  | 1.00  | 1.00  | 1.00  | 1.00  | 1.00  | 0.00  |
| Uniform Delay (d), s/veh     | 27.6  | 7.4   | 7.4   | 26.3  | 5.1   | 5.1   | 27.5  | 26.5  | 26.8  | 26.8  | 25.4  | 0.0   |
| Incr Delay (d2), s/veh       | 19.7  | 1.1   | 1.0   | 6.9   | 0.2   | 0.2   | 19.6  | 0.1   | 5.0   | 6.3   | 0.1   | 0.0   |
| Initial Q Delay(d3),s/veh    | 0.0   | 0.0   | 0.0   | 0.0   | 0.0   | 0.0   | 0.0   | 0.0   | 0.0   | 0.0   | 0.0   | 0.0   |
| %ile BackOfQ(50%),veh/ln     | 0.0   | 3.9   | 4.1   | 1.1   | 1.0   | 1.0   | 0.1   | 0.0   | 0.3   | 0.5   | 0.0   | 0.0   |
| LnGrp Delay(d),s/veh         | 47.4  | 8.5   | 8.4   | 33.2  | 5.3   | 5.3   | 47.1  | 26.6  | 31.8  | 33.1  | 25.4  | 0.0   |
| LnGrp LOS                    | D   | A   | A   | C   | A   | A   | D   | C   | C   | C   | C   |   |
| Approach Vol, veh/h          |   | 839   |   |   | 348   |   |   | 24  |   |   | 31  |   |
| Approach Delay, s/veh        |   | 8.5   |   |   | 10.2  |   |   | 34.2  |   |   | 32.6  |   |
| Approach LOS                 |   | A   |   |   | B   |   |   | C   |   |   | C   |   |
| Timer                        | 1   | 2   | 3   | 4   | 5   | 6   | 7   | 8   |   |   |   |   |
| Assigned Phs                 | 1   | 2   | 3   | 4   | 5   | 6   | 7   | 8   |   |   |   |   |
| Phs Duration (G+Y+Rc), s     | 7.4   | 35.3  | 5.2   | 7.4   | 5.1   | 37.7  | 6.4   | 6.2   |   |   |   |   |
| Change Period (Y+Rc), s      | 5.0   | 5.0   | 5.0   | 5.0   | 5.0   | 5.0   | 5.0   | 5.0   |   |   |   |   |
| Max Green Setting (Gmax), s  | 30.0  | 48.0  | 30.0  | 30.0  | 30.0  | 48.0  | 30.0  | 30.0  |   |   |   |   |
| Max Q Clear Time (g_c+I1), s | 3.9   | 9.6   | 2.1   | 2.1   | 2.0   | 4.1   | 3.0   | 2.7   |   |   |   |   |
| Green Ext Time (p_c), s      | 0.1   | 20.7  | 0.0   | 0.0   | 0.0   | 22.3  | 0.0   | 0.0   |   |   |   |   |
| <b>Intersection Summary</b>  |   |   |   |   |   |   |   |   |   |   |   |   |
| HCM 2010 Ctrl Delay          |   |   |   | 10.1  |   |   |   |   |   |   |   |   |
| HCM 2010 LOS                 |   |   |   | B   |   |   |   |   |   |   |   |   |





















HCM 2010 Signalized Intersection Summary  
 17: Airport Way & Ralph Avenue

Stockton General Plan  
 Existing AM

|                              |  |  |  |  |  |  |  |  |  |  |  |  |
|------------------------------|---|---|---|---|---|---|--|---|---|---|---|---|
| Movement                     | EBL   | EBT   | EBR   | WBL   | WBT   | WBR   | NBL  | NBT   | NBR   | SBL   | SBT   | SBR   |
| Lane Configurations          |   |  |   |   |  |  |  |  |  |  |  |  |
| Traffic Volume (veh/h)       | 21  | 1   | 7   | 28  | 3   | 95  | 25   | 441   | 11  | 148   | 392   | 37  |
| Future Volume (veh/h)        | 21  | 1   | 7   | 28  | 3   | 95  | 25   | 441   | 11  | 148   | 392   | 37  |
| Number                       | 3   | 8   | 18  | 7   | 4   | 14  | 5  | 2   | 12  | 1   | 6   | 16  |
| Initial Q (Qb), veh          | 0   | 0   | 0   | 0   | 0   | 0   | 0  | 0   | 0   | 0   | 0   | 0   |
| Ped-Bike Adj(A_pbT)          | 0.99  |   | 0.99  | 0.99  |   | 0.99  | 1.00   |   | 1.00  | 1.00  |   | 1.00  |
| Parking Bus, Adj             | 1.00  | 1.00  | 1.00  | 1.00  | 1.00  | 1.00  | 1.00   | 1.00  | 1.00  | 1.00  | 1.00  | 1.00  |
| Adj Sat Flow, veh/h/ln       | 1900  | 1281  | 1900  | 1900  | 1781  | 1845  | 1638   | 1808  | 1900  | 1776  | 1792  | 1712  |
| Adj Flow Rate, veh/h         | 24  | 1   | 1   | 32  | 3   | 15  | 28   | 501   | 10  | 168   | 445   | 24  |
| Adj No. of Lanes             | 0   | 1   | 0   | 0   | 1   | 1   | 1  | 2   | 0   | 1   | 2   | 1   |
| Peak Hour Factor             | 0.88  | 0.88  | 0.88  | 0.88  | 0.88  | 0.88  | 0.88   | 0.88  | 0.88  | 0.88  | 0.88  | 0.88  |
| Percent Heavy Veh, %         | 3   | 3   | 3   | 3   | 3   | 3   | 16   | 5   | 5   | 7   | 6   | 11  |
| Cap, veh/h                   | 182   | 6   | 2   | 234   | 11  | 105   | 40   | 1668  | 33  | 214   | 1992  | 851   |
| Arrive On Green              | 0.07  | 0.07  | 0.07  | 0.07  | 0.07  | 0.07  | 0.03   | 0.48  | 0.48  | 0.13  | 0.58  | 0.58  |
| Sat Flow, veh/h              | 629   | 86  | 29  | 1414  | 157   | 1556  | 1560   | 3444  | 69  | 1691  | 3406  | 1455  |
| Grp Volume(v), veh/h         | 26  | 0   | 0   | 35  | 0   | 15  | 28   | 250   | 261   | 168   | 445   | 24  |
| Grp Sat Flow(s),veh/h/ln     | 744   | 0   | 0   | 1571  | 0   | 1556  | 1560   | 1717  | 1796  | 1691  | 1703  | 1455  |
| Q Serve(g_s), s              | 1.1   | 0.0   | 0.0   | 0.0   | 0.0   | 0.5   | 0.9  | 4.4   | 4.4   | 4.8   | 3.1   | 0.3   |
| Cycle Q Clear(g_c), s        | 2.1   | 0.0   | 0.0   | 1.0   | 0.0   | 0.5   | 0.9  | 4.4   | 4.4   | 4.8   | 3.1   | 0.3   |
| Prop In Lane                 | 0.92  |   | 0.04  | 0.91  |   | 1.00  | 1.00   |   | 0.04  | 1.00  |   | 1.00  |
| Lane Grp Cap(c), veh/h       | 189   | 0   | 0   | 244   | 0   | 105   | 40   | 832   | 870   | 214   | 1992  | 851   |
| V/C Ratio(X)                 | 0.14  | 0.00  | 0.00  | 0.14  | 0.00  | 0.14  | 0.70   | 0.30  | 0.30  | 0.79  | 0.22  | 0.03  |
| Avail Cap(c_a), veh/h        | 589   | 0   | 0   | 813   | 0   | 752   | 753  | 1659  | 1734  | 817   | 3289  | 1405  |
| HCM Platoon Ratio            | 1.00  | 1.00  | 1.00  | 1.00  | 1.00  | 1.00  | 1.00   | 1.00  | 1.00  | 1.00  | 1.00  | 1.00  |
| Upstream Filter(I)           | 1.00  | 0.00  | 0.00  | 1.00  | 0.00  | 1.00  | 1.00   | 1.00  | 1.00  | 1.00  | 1.00  | 1.00  |
| Uniform Delay (d), s/veh     | 22.8  | 0.0   | 0.0   | 22.1  | 0.0   | 21.8  | 24.0   | 7.7   | 7.7   | 21.1  | 4.9   | 4.4   |
| Incr Delay (d2), s/veh       | 0.1   | 0.0   | 0.0   | 0.1   | 0.0   | 0.2   | 7.8  | 0.7   | 0.7   | 2.4   | 0.2   | 0.0   |
| Initial Q Delay(d3),s/veh    | 0.0   | 0.0   | 0.0   | 0.0   | 0.0   | 0.0   | 0.0  | 0.0   | 0.0   | 0.0   | 0.0   | 0.0   |
| %ile BackOfQ(50%),veh/ln     | 0.4   | 0.0   | 0.0   | 0.5   | 0.0   | 0.2   | 0.5  | 2.2   | 2.3   | 2.4   | 1.5   | 0.2   |
| LnGrp Delay(d),s/veh         | 22.9  | 0.0   | 0.0   | 22.2  | 0.0   | 22.1  | 31.8   | 8.5   | 8.4   | 23.5  | 5.1   | 4.4   |
| LnGrp LOS                    | C   |   |   | C   |   | C   | C  | A   | A   | C   | A   | A   |
| Approach Vol, veh/h          |   | 26  |   |   | 50  |   |  | 539   |   |   | 637   |   |
| Approach Delay, s/veh        |   | 22.9  |   |   | 22.1  |   |  | 9.7   |   |   | 9.9   |   |
| Approach LOS                 |   | C   |   |   | C   |   |  | A   |   |   | A   |   |
| Timer                        | 1   | 2   | 3   | 4   | 5   | 6   | 7  | 8   |   |   |   |   |
| Assigned Phs                 | 1   | 2   |   | 4   | 5   | 6   |  | 8   |   |   |   |   |
| Phs Duration (G+Y+Rc), s     | 11.3  | 30.1  |   | 8.3   | 6.3   | 35.1  |  | 8.3   |   |   |   |   |
| Change Period (Y+Rc), s      | 5.0   | 6.0   |   | 5.0   | 5.0   | 6.0   |  | 5.0   |   |   |   |   |
| Max Green Setting (Gmax), s  | 24.0  | 48.0  |   | 24.0  | 24.0  | 48.0  |  | 24.0  |   |   |   |   |
| Max Q Clear Time (g_c+I1), s | 6.8   | 6.4   |   | 3.0   | 2.9   | 5.1   |  | 4.1   |   |   |   |   |
| Green Ext Time (p_c), s      | 0.2   | 17.7  |   | 0.2   | 0.0   | 17.9  |  | 0.2   |   |   |   |   |
| <b>Intersection Summary</b>  |   |   |   |   |   |   |  |   |   |   |   |   |
| HCM 2010 Ctrl Delay          |   |   |   | 10.6  |   |   |  |   |   |   |   |   |
| HCM 2010 LOS                 |   |   |   | B   |   |   |  |   |   |   |   |   |
| <b>Notes</b>                 |   |   |   |   |   |   |  |   |   |   |   |   |





















HCM 2010 Signalized Intersection Summary  
 18: Airport Way & Sperry Road/Arch Airport Road

Stockton General Plan  
 Existing AM

|                              |  |  |  |  |  |  |   |  |  |  |  |  |
|------------------------------|---|---|---|---|---|---|---|---|---|---|---|---|
| Movement                     | EBL   | EBT   | EBR   | WBL   | WBT   | WBR   | NBL   | NBT   | NBR   | SBL   | SBT   | SBR   |
| Lane Configurations          |  |  |   |  |  |   |  |  |   |  |  |   |
| Traffic Volume (veh/h)       | 197   | 663   | 48  | 143   | 449   | 105   | 39  | 201   | 121   | 118   | 130   | 178   |
| Future Volume (veh/h)        | 197   | 663   | 48  | 143   | 449   | 105   | 39  | 201   | 121   | 118   | 130   | 178   |
| Number                       | 7   | 4   | 14  | 3   | 8   | 18  | 5   | 2   | 12  | 1   | 6   | 16  |
| Initial Q (Qb), veh          | 0   | 0   | 0   | 0   | 0   | 0   | 0   | 0   | 0   | 0   | 0   | 0   |
| Ped-Bike Adj(A_pbT)          | 1.00  |   | 1.00  | 1.00  |   | 1.00  | 1.00  |   | 1.00  | 1.00  |   | 1.00  |
| Parking Bus, Adj             | 1.00  | 1.00  | 1.00  | 1.00  | 1.00  | 1.00  | 1.00  | 1.00  | 1.00  | 1.00  | 1.00  | 1.00  |
| Adj Sat Flow, veh/h/ln       | 1597  | 1668  | 1900  | 1624  | 1639  | 1900  | 1610  | 1733  | 1900  | 1570  | 1535  | 1900  |
| Adj Flow Rate, veh/h         | 226   | 762   | 52  | 164   | 516   | 108   | 45  | 231   | 76  | 136   | 149   | 54  |
| Adj No. of Lanes             | 1   | 2   | 0   | 1   | 2   | 0   | 1   | 2   | 0   | 1   | 2   | 0   |
| Peak Hour Factor             | 0.87  | 0.87  | 0.87  | 0.87  | 0.87  | 0.87  | 0.87  | 0.87  | 0.87  | 0.87  | 0.87  | 0.87  |
| Percent Heavy Veh, %         | 19  | 14  | 14  | 17  | 14  | 14  | 18  | 10  | 10  | 21  | 18  | 18  |
| Cap, veh/h                   | 260   | 944   | 64  | 196   | 692   | 144   | 53  | 461   | 148   | 164   | 558   | 195   |
| Arrive On Green              | 0.17  | 0.31  | 0.31  | 0.13  | 0.27  | 0.27  | 0.03  | 0.19  | 0.19  | 0.11  | 0.26  | 0.26  |
| Sat Flow, veh/h              | 1521  | 3010  | 205   | 1547  | 2567  | 535   | 1533  | 2454  | 787   | 1495  | 2121  | 740   |
| Grp Volume(v), veh/h         | 226   | 401   | 413   | 164   | 312   | 312   | 45  | 153   | 154   | 136   | 101   | 102   |
| Grp Sat Flow(s),veh/h/ln     | 1521  | 1584  | 1631  | 1547  | 1557  | 1545  | 1533  | 1647  | 1594  | 1495  | 1458  | 1403  |
| Q Serve(g_s), s              | 12.2  | 19.5  | 19.5  | 8.7   | 15.4  | 15.5  | 2.5   | 7.0   | 7.3   | 7.5   | 4.6   | 4.9   |
| Cycle Q Clear(g_c), s        | 12.2  | 19.5  | 19.5  | 8.7   | 15.4  | 15.5  | 2.5   | 7.0   | 7.3   | 7.5   | 4.6   | 4.9   |
| Prop In Lane                 | 1.00  |   | 0.13  | 1.00  |   | 0.35  | 1.00  |   | 0.49  | 1.00  |   | 0.53  |
| Lane Grp Cap(c), veh/h       | 260   | 497   | 512   | 196   | 420   | 417   | 53  | 309   | 299   | 164   | 383   | 369   |
| V/C Ratio(X)                 | 0.87  | 0.81  | 0.81  | 0.84  | 0.74  | 0.75  | 0.85  | 0.49  | 0.51  | 0.83  | 0.26  | 0.28  |
| Avail Cap(c_a), veh/h        | 507   | 604   | 622   | 516   | 649   | 644   | 456   | 627   | 607   | 534   | 556   | 535   |
| HCM Platoon Ratio            | 1.00  | 1.00  | 1.00  | 1.00  | 1.00  | 1.00  | 1.00  | 1.00  | 1.00  | 1.00  | 1.00  | 1.00  |
| Upstream Filter(I)           | 1.00  | 1.00  | 1.00  | 1.00  | 1.00  | 1.00  | 1.00  | 1.00  | 1.00  | 1.00  | 1.00  | 1.00  |
| Uniform Delay (d), s/veh     | 33.9  | 26.5  | 26.5  | 35.8  | 28.0  | 28.1  | 40.3  | 30.5  | 30.7  | 36.6  | 24.5  | 24.6  |
| Incr Delay (d2), s/veh       | 3.5   | 5.4   | 5.3   | 3.6   | 1.0   | 1.0   | 12.6  | 4.4   | 4.9   | 4.0   | 1.3   | 1.5   |
| Initial Q Delay(d3),s/veh    | 0.0   | 0.0   | 0.0   | 0.0   | 0.0   | 0.0   | 0.0   | 0.0   | 0.0   | 0.0   | 0.0   | 0.0   |
| %ile BackOfQ(50%),veh/ln     | 5.3   | 9.2   | 9.5   | 3.9   | 6.7   | 6.7   | 1.2   | 3.6   | 3.6   | 3.3   | 2.0   | 2.0   |
| LnGrp Delay(d),s/veh         | 37.4  | 31.9  | 31.8  | 39.4  | 29.0  | 29.1  | 52.9  | 34.9  | 35.6  | 40.6  | 25.8  | 26.1  |
| LnGrp LOS                    | D   | C   | C   | D   | C   | C   | D   | C   | D   | D   | C   | C   |
| Approach Vol, veh/h          |   | 1040  |   |   | 788   |   |   | 352   |   |   | 339   |   |
| Approach Delay, s/veh        |   | 33.1  |   |   | 31.2  |   |   | 37.5  |   |   | 31.8  |   |
| Approach LOS                 |   | C   |   |   | C   |   |   | D   |   |   | C   |   |
| Timer                        | 1   | 2   | 3   | 4   | 5   | 6   | 7   | 8   |   |   |   |   |
| Assigned Phs                 | 1   | 2   | 3   | 4   | 5   | 6   | 7   | 8   |   |   |   |   |
| Phs Duration (G+Y+Rc), s     | 14.2  | 21.8  | 15.6  | 32.3  | 7.9   | 28.1  | 19.3  | 28.6  |   |   |   |   |
| Change Period (Y+Rc), s      | 5.0   | 6.0   | 5.0   | 6.0   | 5.0   | 6.0   | 5.0   | 6.0   |   |   |   |   |
| Max Green Setting (Gmax), s  | 30.0  | 32.0  | 28.0  | 32.0  | 25.0  | 32.0  | 28.0  | 35.0  |   |   |   |   |
| Max Q Clear Time (g_c+I1), s | 9.5   | 9.3   | 10.7  | 21.5  | 4.5   | 6.9   | 14.2  | 17.5  |   |   |   |   |
| Green Ext Time (p_c), s      | 0.2   | 6.5   | 0.2   | 4.1   | 0.0   | 6.8   | 0.3   | 5.1   |   |   |   |   |
| <b>Intersection Summary</b>  |   |   |   |   |   |   |   |   |   |   |   |   |
| HCM 2010 Ctrl Delay          |   |   |   | 32.9  |   |   |   |   |   |   |   |   |
| HCM 2010 LOS                 |   |   |   | C   |   |   |   |   |   |   |   |   |

























HCM 2010 Signalized Intersection Summary  
 19: Newcastle Road & Arch Road

Stockton General Plan  
 Existing AM











|                              |  |  |  |  |  |  |  |  |  |  |  |  |
|------------------------------|---|---|---|---|---|---|--|---|---|---|---|---|
| Movement                     | EBL   | EBT   | EBR   | WBL   | WBT   | WBR   | NBL  | NBT   | NBR   | SBL   | SBT   | SBR   |
| Lane Configurations          |  |  |   |  |  |  |  |  |   |   |  |  |
| Traffic Volume (veh/h)       | 17  | 180   | 5   | 42  | 330   | 170   | 2  | 0   | 23  | 7   | 1   | 5   |
| Future Volume (veh/h)        | 17  | 180   | 5   | 42  | 330   | 170   | 2  | 0   | 23  | 7   | 1   | 5   |
| Number                       | 5   | 2   | 12  | 1   | 6   | 16  | 3  | 8   | 18  | 7   | 4   | 14  |
| Initial Q (Qb), veh          | 0   | 0   | 0   | 0   | 0   | 0   | 0  | 0   | 0   | 0   | 0   | 0   |
| Ped-Bike Adj(A_pbT)          | 1.00  |   | 1.00  | 1.00  |   | 1.00  | 1.00   |   | 1.00  | 1.00  |   | 1.00  |
| Parking Bus, Adj             | 1.00  | 1.00  | 1.00  | 1.00  | 1.00  | 1.00  | 1.00   | 1.00  | 1.00  | 1.00  | 1.00  | 1.00  |
| Adj Sat Flow, veh/h/ln       | 1696  | 1426  | 1900  | 1597  | 1667  | 1845  | 1900   | 1528  | 1900  | 1900  | 1272  | 1583  |
| Adj Flow Rate, veh/h         | 19  | 205   | 5   | 48  | 375   | 102   | 2  | 0   | 0   | 8   | 1   | 0   |
| Adj No. of Lanes             | 1   | 1   | 0   | 1   | 1   | 1   | 0  | 1   | 0   | 0   | 1   | 1   |
| Peak Hour Factor             | 0.88  | 0.88  | 0.88  | 0.88  | 0.88  | 0.88  | 0.88   | 0.88  | 0.88  | 0.88  | 0.88  | 0.88  |
| Percent Heavy Veh, %         | 12  | 33  | 33  | 19  | 14  | 3   | 3  | 3   | 3   | 100   | 100   | 20  |
| Cap, veh/h                   | 31  | 684   | 17  | 65  | 860   | 809   | 220  | 0   | 0   | 203   | 1   | 16  |
| Arrive On Green              | 0.02  | 0.49  | 0.49  | 0.04  | 0.52  | 0.52  | 0.01   | 0.00  | 0.00  | 0.01  | 0.01  | 0.00  |
| Sat Flow, veh/h              | 1616  | 1387  | 34  | 1521  | 1667  | 1568  | 1382   | 0   | 0   | 905   | 113   | 1346  |
| Grp Volume(v), veh/h         | 19  | 0   | 210   | 48  | 375   | 102   | 2  | 0   | 0   | 9   | 0   | 0   |
| Grp Sat Flow(s),veh/h/ln     | 1616  | 0   | 1420  | 1521  | 1667  | 1568  | 1382   | 0   | 0   | 1018  | 0   | 1346  |
| Q Serve(g_s), s              | 0.4   | 0.0   | 3.1   | 1.1   | 5.0   | 1.2   | 0.0  | 0.0   | 0.0   | 0.3   | 0.0   | 0.0   |
| Cycle Q Clear(g_c), s        | 0.4   | 0.0   | 3.1   | 1.1   | 5.0   | 1.2   | 0.0  | 0.0   | 0.0   | 0.3   | 0.0   | 0.0   |
| Prop In Lane                 | 1.00  |   | 0.02  | 1.00  |   | 1.00  | 1.00   |   | 0.00  | 0.89  |   | 1.00  |
| Lane Grp Cap(c), veh/h       | 31  | 0   | 700   | 65  | 860   | 809   | 220  | 0   | 0   | 204   | 0   | 16  |
| V/C Ratio(X)                 | 0.61  | 0.00  | 0.30  | 0.74  | 0.44  | 0.13  | 0.01   | 0.00  | 0.00  | 0.04  | 0.00  | 0.00  |
| Avail Cap(c_a), veh/h        | 1464  | 0   | 1930  | 775   | 2265  | 2131  | 993  | 0   | 0   | 866   | 0   | 914   |
| HCM Platoon Ratio            | 1.00  | 1.00  | 1.00  | 1.00  | 1.00  | 1.00  | 1.00   | 1.00  | 1.00  | 1.00  | 1.00  | 1.00  |
| Upstream Filter(I)           | 1.00  | 0.00  | 1.00  | 1.00  | 1.00  | 1.00  | 1.00   | 0.00  | 0.00  | 1.00  | 0.00  | 0.00  |
| Uniform Delay (d), s/veh     | 17.2  | 0.0   | 5.3   | 16.7  | 5.3   | 4.4   | 17.3   | 0.0   | 0.0   | 17.4  | 0.0   | 0.0   |
| Incr Delay (d2), s/veh       | 7.0   | 0.0   | 0.9   | 6.1   | 1.3   | 0.3   | 0.0  | 0.0   | 0.0   | 0.0   | 0.0   | 0.0   |
| Initial Q Delay(d3),s/veh    | 0.0   | 0.0   | 0.0   | 0.0   | 0.0   | 0.0   | 0.0  | 0.0   | 0.0   | 0.0   | 0.0   | 0.0   |
| %ile BackOfQ(50%),veh/ln     | 0.2   | 0.0   | 1.3   | 0.6   | 2.5   | 0.6   | 0.0  | 0.0   | 0.0   | 0.1   | 0.0   | 0.0   |
| LnGrp Delay(d),s/veh         | 24.2  | 0.0   | 6.2   | 22.8  | 6.6   | 4.7   | 17.3   | 0.0   | 0.0   | 17.4  | 0.0   | 0.0   |
| LnGrp LOS                    | C   |   | A   | C   | A   | A   | B  |   |   | B   |   |   |
| Approach Vol, veh/h          |   | 229   |   |   | 525   |   |  | 2   |   |   |   | 9   |
| Approach Delay, s/veh        |   | 7.7   |   |   | 7.7   |   |  | 17.3  |   |   |   | 17.4  |
| Approach LOS                 |   | A   |   |   | A   |   |  | B   |   |   |   | B   |
| Timer                        | 1   | 2   | 3   | 4   | 5   | 6   | 7  | 8   |   |   |   |   |
| Assigned Phs                 | 1   | 2   |   | 4   | 5   | 6   |  | 8   |   |   |   |   |
| Phs Duration (G+Y+Rc), s     | 6.5   | 23.4  |   | 5.4   | 5.7   | 24.2  |  | 5.4   |   |   |   |   |
| Change Period (Y+Rc), s      | 5.0   | 6.0   |   | 5.0   | 5.0   | 6.0   |  | 5.0   |   |   |   |   |
| Max Green Setting (Gmax), s  | 18.0  | 48.0  |   | 24.0  | 32.0  | 48.0  |  | 24.0  |   |   |   |   |
| Max Q Clear Time (g_c+I1), s | 3.1   | 5.1   |   | 2.3   | 2.4   | 7.0   |  | 2.0   |   |   |   |   |
| Green Ext Time (p_c), s      | 0.0   | 11.6  |   | 0.0   | 0.0   | 11.4  |  | 0.0   |   |   |   |   |
| <b>Intersection Summary</b>  |   |   |   |   |   |   |  |   |   |   |   |   |
| HCM 2010 Ctrl Delay          |   |   | 7.8   |   |   |   |  |   |   |   |   |   |
| HCM 2010 LOS                 |   |   | A   |   |   |   |  |   |   |   |   |   |

HCM 2010 Signalized Intersection Summary  
20: Airport Way & French Camp Road





















Stockton General Plan  
Existing AM

|                              |  |  |  |  |  |  |   |  |  |  |  |  |
|------------------------------|---|---|---|---|---|---|---|---|---|---|---|---|
| Movement                     | EBL   | EBT   | EBR   | WBL   | WBT   | WBR   | NBL   | NBT   | NBR   | SBL   | SBT   | SBR   |
| Lane Configurations          |  |  |  |  |  |  |  |  |  |  |  |  |
| Traffic Volume (veh/h)       | 37  | 169   | 32  | 29  | 266   | 195   | 45  | 225   | 18  | 71  | 130   | 21  |
| Future Volume (veh/h)        | 37  | 169   | 32  | 29  | 266   | 195   | 45  | 225   | 18  | 71  | 130   | 21  |
| Number                       | 1   | 6   | 16  | 5   | 2   | 12  | 7   | 4   | 14  | 3   | 8   | 18  |
| Initial Q (Qb), veh          | 0   | 0   | 0   | 0   | 0   | 0   | 0   | 0   | 0   | 0   | 0   | 0   |
| Ped-Bike Adj(A_pbT)          | 1.00  |   | 1.00  | 1.00  |   | 1.00  | 1.00  |   | 1.00  | 1.00  |   | 1.00  |
| Parking Bus, Adj             | 1.00  | 1.00  | 1.00  | 1.00  | 1.00  | 1.00  | 1.00  | 1.00  | 1.00  | 1.00  | 1.00  | 1.00  |
| Adj Sat Flow, veh/h/ln       | 1496  | 1667  | 1484  | 1348  | 1696  | 1792  | 1681  | 1736  | 1900  | 1462  | 1439  | 1597  |
| Adj Flow Rate, veh/h         | 44  | 201   | 13  | 35  | 317   | 0   | 54  | 268   | 17  | 85  | 155   | 15  |
| Adj No. of Lanes             | 1   | 1   | 1   | 1   | 1   | 1   | 1   | 2   | 0   | 1   | 1   | 1   |
| Peak Hour Factor             | 0.84  | 0.84  | 0.84  | 0.84  | 0.84  | 0.84  | 0.84  | 0.84  | 0.84  | 0.84  | 0.84  | 0.84  |
| Percent Heavy Veh, %         | 27  | 14  | 28  | 41  | 12  | 6   | 13  | 8   | 8   | 30  | 32  | 19  |
| Cap, veh/h                   | 73  | 546   | 413   | 56  | 543   | 488   | 94  | 723   | 46  | 108   | 358   | 337   |
| Arrive On Green              | 0.05  | 0.33  | 0.33  | 0.04  | 0.32  | 0.00  | 0.06  | 0.23  | 0.23  | 0.08  | 0.25  | 0.25  |
| Sat Flow, veh/h              | 1425  | 1667  | 1262  | 1283  | 1696  | 1524  | 1601  | 3151  | 199   | 1392  | 1439  | 1357  |
| Grp Volume(v), veh/h         | 44  | 201   | 13  | 35  | 317   | 0   | 54  | 140   | 145   | 85  | 155   | 15  |
| Grp Sat Flow(s),veh/h/ln     | 1425  | 1667  | 1262  | 1283  | 1696  | 1524  | 1601  | 1649  | 1701  | 1392  | 1439  | 1357  |
| Q Serve(g_s), s              | 1.9   | 5.7   | 0.4   | 1.7   | 9.7   | 0.0   | 2.0   | 4.4   | 4.5   | 3.7   | 5.6   | 0.5   |
| Cycle Q Clear(g_c), s        | 1.9   | 5.7   | 0.4   | 1.7   | 9.7   | 0.0   | 2.0   | 4.4   | 4.5   | 3.7   | 5.6   | 0.5   |
| Prop In Lane                 | 1.00  |   | 1.00  | 1.00  |   | 1.00  | 1.00  |   | 0.12  | 1.00  |   | 1.00  |
| Lane Grp Cap(c), veh/h       | 73  | 546   | 413   | 56  | 543   | 488   | 94  | 379   | 390   | 108   | 358   | 337   |
| V/C Ratio(X)                 | 0.60  | 0.37  | 0.03  | 0.62  | 0.58  | 0.00  | 0.58  | 0.37  | 0.37  | 0.79  | 0.43  | 0.04  |
| Avail Cap(c_a), veh/h        | 642   | 911   | 690   | 578   | 928   | 833   | 979   | 902   | 930   | 851   | 856   | 807   |
| HCM Platoon Ratio            | 1.00  | 1.00  | 1.00  | 1.00  | 1.00  | 1.00  | 1.00  | 1.00  | 1.00  | 1.00  | 1.00  | 1.00  |
| Upstream Filter(I)           | 1.00  | 1.00  | 1.00  | 1.00  | 1.00  | 0.00  | 1.00  | 1.00  | 1.00  | 1.00  | 1.00  | 1.00  |
| Uniform Delay (d), s/veh     | 28.9  | 16.0  | 14.2  | 29.2  | 17.7  | 0.0   | 28.5  | 20.2  | 20.2  | 28.2  | 19.7  | 17.8  |
| Incr Delay (d2), s/veh       | 15.8  | 1.9   | 0.1   | 21.7  | 4.5   | 0.0   | 11.4  | 2.8   | 2.7   | 23.2  | 3.8   | 0.2   |
| Initial Q Delay(d3),s/veh    | 0.0   | 0.0   | 0.0   | 0.0   | 0.0   | 0.0   | 0.0   | 0.0   | 0.0   | 0.0   | 0.0   | 0.0   |
| %ile BackOfQ(50%),veh/ln     | 1.1   | 2.9   | 0.2   | 0.9   | 5.2   | 0.0   | 1.2   | 2.3   | 2.4   | 2.1   | 2.6   | 0.2   |
| LnGrp Delay(d),s/veh         | 44.6  | 17.9  | 14.3  | 50.9  | 22.2  | 0.0   | 39.9  | 22.9  | 22.9  | 51.4  | 23.5  | 18.0  |
| LnGrp LOS                    | D   | B   | B   | D   | C   |   | D   | C   | C   | D   | C   | B   |
| Approach Vol, veh/h          |   | 258   |   |   | 352   |   |   | 339   |   |   | 255   |   |
| Approach Delay, s/veh        |   | 22.3  |   |   | 25.1  |   |   | 25.6  |   |   | 32.5  |   |
| Approach LOS                 |   | C   |   |   | C   |   |   | C   |   |   | C   |   |
| Timer                        | 1   | 2   | 3   | 4   | 5   | 6   | 7   | 8   |   |   |   |   |
| Assigned Phs                 | 1   | 2   | 3   | 4   | 5   | 6   | 7   | 8   |   |   |   |   |
| Phs Duration (G+Y+Rc), s     | 8.2   | 24.9  | 9.8   | 19.3  | 7.7   | 25.4  | 8.6   | 20.4  |   |   |   |   |
| Change Period (Y+Rc), s      | 5.0   | 5.0   | 5.0   | 5.0   | 5.0   | 5.0   | 5.0   | 5.0   |   |   |   |   |
| Max Green Setting (Gmax), s  | 28.0  | 34.0  | 38.0  | 34.0  | 28.0  | 34.0  | 38.0  | 37.0  |   |   |   |   |
| Max Q Clear Time (g_c+I1), s | 3.9   | 11.7  | 5.7   | 6.5   | 3.7   | 7.7   | 4.0   | 7.6   |   |   |   |   |
| Green Ext Time (p_c), s      | 0.2   | 8.2   | 0.5   | 7.6   | 0.1   | 8.9   | 0.3   | 7.8   |   |   |   |   |
| <b>Intersection Summary</b>  |   |   |   |   |   |   |   |   |   |   |   |   |
| HCM 2010 Ctrl Delay          |   |   | 26.2  |   |   |   |   |   |   |   |   |   |
| HCM 2010 LOS                 |   |   | C   |   |   |   |   |   |   |   |   |   |

HCM 2010 Signalized Intersection Summary  
 1: Trinity Parkway & Eight Mile Road

|                              |  |  |  |  |  |  |   |   |
|------------------------------|---|---|---|---|---|---|---|---|
| Movement                     | EBT   | EBR   | WBL   | WBT   | NBL   | NBR   |   |   |
| Lane Configurations          |  |   |  |  |  |  |   |   |
| Traffic Volume (veh/h)       | 316   | 30  | 1131  | 457   | 38  | 1249  |   |   |
| Future Volume (veh/h)        | 316   | 30  | 1131  | 457   | 38  | 1249  |   |   |
| Number                       | 2   | 12  | 1   | 6   | 7   | 14  |   |   |
| Initial Q (Qb), veh          | 0   | 0   | 0   | 0   | 0   | 0   |   |   |
| Ped-Bike Adj(A_pbT)          |   | 1.00  | 1.00  |   | 1.00  | 1.00  |   |   |
| Parking Bus, Adj             | 1.00  | 1.00  | 1.00  | 1.00  | 1.00  | 1.00  |   |   |
| Adj Sat Flow, veh/h/ln       | 1845  | 1900  | 1845  | 1845  | 1810  | 1845  |   |   |
| Adj Flow Rate, veh/h         | 329   | 13  | 1178  | 476   | 40  | 1123  |   |   |
| Adj No. of Lanes             | 4   | 0   | 2   | 2   | 2   | 2   |   |   |
| Peak Hour Factor             | 0.96  | 0.96  | 0.96  | 0.96  | 0.96  | 0.96  |   |   |
| Percent Heavy Veh, %         | 3   | 3   | 3   | 3   | 5   | 3   |   |   |
| Cap, veh/h                   | 902   | 35  | 1421  | 2242  | 669   | 946   |   |   |
| Arrive On Green              | 0.14  | 0.14  | 0.42  | 0.64  | 0.20  | 0.20  |   |   |
| Sat Flow, veh/h              | 6572  | 246   | 3408  | 3597  | 3343  | 2760  |   |   |
| Grp Volume(v), veh/h         | 247   | 95  | 1178  | 476   | 40  | 1123  |   |   |
| Grp Sat Flow(s),veh/h/ln     | 1586  | 1801  | 1704  | 1752  | 1672  | 1380  |   |   |
| Q Serve(g_s), s              | 3.5   | 3.6   | 23.1  | 4.2   | 0.7   | 15.0  |   |   |
| Cycle Q Clear(g_c), s        | 3.5   | 3.6   | 23.1  | 4.2   | 0.7   | 15.0  |   |   |
| Prop In Lane                 |   | 0.14  | 1.00  |   | 1.00  | 1.00  |   |   |
| Lane Grp Cap(c), veh/h       | 680   | 257   | 1421  | 2242  | 669   | 946   |   |   |
| V/C Ratio(X)                 | 0.36  | 0.37  | 0.83  | 0.21  | 0.06  | 1.19  |   |   |
| Avail Cap(c_a), veh/h        | 2223  | 841   | 1592  | 2242  | 669   | 946   |   |   |
| HCM Platoon Ratio            | 1.00  | 1.00  | 1.00  | 1.00  | 1.00  | 1.00  |   |   |
| Upstream Filter(I)           | 1.00  | 1.00  | 1.00  | 1.00  | 1.00  | 1.00  |   |   |
| Uniform Delay (d), s/veh     | 29.0  | 29.1  | 19.5  | 5.6   | 24.3  | 21.1  |   |   |
| Incr Delay (d2), s/veh       | 1.2   | 3.2   | 4.2   | 0.2   | 0.0   | 94.7  |   |   |
| Initial Q Delay(d3),s/veh    | 0.0   | 0.0   | 0.0   | 0.0   | 0.0   | 0.0   |   |   |
| %ile BackOfQ(50%),veh/ln     | 1.6   | 2.0   | 11.6  | 2.1   | 0.3   | 22.2  |   |   |
| LnGrp Delay(d),s/veh         | 30.2  | 32.3  | 23.7  | 5.8   | 24.3  | 115.8   |   |   |
| LnGrp LOS                    | C   | C   | C   | A   | C   | F   |   |   |
| Approach Vol, veh/h          | 342   |   |   | 1654  | 1163  |   |   |   |
| Approach Delay, s/veh        | 30.8  |   |   | 18.5  | 112.7   |   |   |   |
| Approach LOS                 | C   |   |   | B   | F   |   |   |   |
| Timer                        | 1   | 2   | 3   | 4   | 5   | 6   | 7 | 8 |
| Assigned Phs                 | 1   | 2   |   | 4   |   | 6   |   |   |
| Phs Duration (G+Y+Rc), s     | 37.2  | 17.7  |   | 20.0  |   | 54.9  |   |   |
| Change Period (Y+Rc), s      | 6.0   | 7.0   |   | 5.0   |   | 7.0   |   |   |
| Max Green Setting (Gmax), s  | 35.0  | 35.0  |   | 15.0  |   | 40.0  |   |   |
| Max Q Clear Time (g_c+I1), s | 25.1  | 5.6   |   | 17.0  |   | 6.2   |   |   |
| Green Ext Time (p_c), s      | 6.2   | 5.1   |   | 0.0   |   | 13.3  |   |   |
| <b>Intersection Summary</b>  |   |   |   |   |   |   |   |   |
| HCM 2010 Ctrl Delay          |   |   | 54.5  |   |   |   |   |   |
| HCM 2010 LOS                 |   |   | D   |   |   |   |   |   |

























HCM 2010 Signalized Intersection Summary  
 2: West Lane & Eight Mile Road

|                              |  |  |  |  |  |  |  |  |  |  |  |  |
|------------------------------|---|---|---|---|---|---|--|---|---|---|---|---|
| Movement                     | EBL   | EBT   | EBR   | WBL   | WBT   | WBR   | NBL  | NBT   | NBR   | SBL   | SBT   | SBR   |
| Lane Configurations          |  |  |  |  |  |   |  |  |   |  |  |   |
| Traffic Volume (veh/h)       | 165   | 396   | 324   | 84  | 474   | 17  | 342  | 428   | 65  | 10  | 407   | 0   |
| Future Volume (veh/h)        | 165   | 396   | 324   | 84  | 474   | 17  | 342  | 428   | 65  | 10  | 407   | 0   |
| Number                       | 5   | 2   | 12  | 1   | 6   | 16  | 3  | 8   | 18  | 7   | 4   | 14  |
| Initial Q (Qb), veh          | 0   | 0   | 0   | 0   | 0   | 0   | 0  | 0   | 0   | 0   | 0   | 0   |
| Ped-Bike Adj(A_pbT)          | 1.00  |   | 1.00  | 1.00  |   | 1.00  | 1.00   |   | 1.00  | 1.00  |   | 1.00  |
| Parking Bus, Adj             | 1.00  | 1.00  | 1.00  | 1.00  | 1.00  | 1.00  | 1.00   | 1.00  | 1.00  | 1.00  | 1.00  | 1.00  |
| Adj Sat Flow, veh/h/ln       | 1845  | 1827  | 1845  | 1845  | 1845  | 1900  | 1845   | 1838  | 1900  | 1727  | 1845  | 1900  |
| Adj Flow Rate, veh/h         | 176   | 421   | 196   | 89  | 504   | 17  | 364  | 455   | 63  | 11  | 433   | 0   |
| Adj No. of Lanes             | 1   | 1   | 1   | 1   | 1   | 0   | 1  | 2   | 0   | 1   | 2   | 0   |
| Peak Hour Factor             | 0.94  | 0.94  | 0.94  | 0.94  | 0.94  | 0.94  | 0.94   | 0.94  | 0.94  | 0.94  | 0.94  | 0.94  |
| Percent Heavy Veh, %         | 3   | 4   | 3   | 3   | 3   | 3   | 3  | 3   | 3   | 10  | 3   | 3   |
| Cap, veh/h                   | 207   | 642   | 551   | 114   | 530   | 18  | 361  | 1297  | 179   | 20  | 796   | 0   |
| Arrive On Green              | 0.12  | 0.35  | 0.35  | 0.06  | 0.30  | 0.30  | 0.21   | 0.42  | 0.42  | 0.01  | 0.23  | 0.00  |
| Sat Flow, veh/h              | 1757  | 1827  | 1568  | 1757  | 1774  | 60  | 1757   | 3083  | 425   | 1645  | 3597  | 0   |
| Grp Volume(v), veh/h         | 176   | 421   | 196   | 89  | 0   | 521   | 364  | 257   | 261   | 11  | 433   | 0   |
| Grp Sat Flow(s),veh/h/ln     | 1757  | 1827  | 1568  | 1757  | 0   | 1834  | 1757   | 1746  | 1761  | 1645  | 1752  | 0   |
| Q Serve(g_s), s              | 14.3  | 28.3  | 13.5  | 7.3   | 0.0   | 40.6  | 30.0   | 14.6  | 14.7  | 1.0   | 15.9  | 0.0   |
| Cycle Q Clear(g_c), s        | 14.3  | 28.3  | 13.5  | 7.3   | 0.0   | 40.6  | 30.0   | 14.6  | 14.7  | 1.0   | 15.9  | 0.0   |
| Prop In Lane                 | 1.00  |   | 1.00  | 1.00  |   | 0.03  | 1.00   |   | 0.24  | 1.00  |   | 0.00  |
| Lane Grp Cap(c), veh/h       | 207   | 642   | 551   | 114   | 0   | 548   | 361  | 734   | 741   | 20  | 796   | 0   |
| V/C Ratio(X)                 | 0.85  | 0.66  | 0.36  | 0.78  | 0.00  | 0.95  | 1.01   | 0.35  | 0.35  | 0.54  | 0.54  | 0.00  |
| Avail Cap(c_a), veh/h        | 361   | 642   | 551   | 361   | 0   | 566   | 361  | 734   | 741   | 338   | 1442  | 0   |
| HCM Platoon Ratio            | 1.00  | 1.00  | 1.00  | 1.00  | 1.00  | 1.00  | 1.00   | 1.00  | 1.00  | 1.00  | 1.00  | 1.00  |
| Upstream Filter(I)           | 1.00  | 1.00  | 1.00  | 1.00  | 0.00  | 1.00  | 1.00   | 1.00  | 1.00  | 1.00  | 1.00  | 0.00  |
| Uniform Delay (d), s/veh     | 63.1  | 39.9  | 35.1  | 67.2  | 0.0   | 50.1  | 57.9   | 28.7  | 28.7  | 71.6  | 49.7  | 0.0   |
| Incr Delay (d2), s/veh       | 18.2  | 4.4   | 1.4   | 21.5  | 0.0   | 27.5  | 49.1   | 1.0   | 1.0   | 28.5  | 2.1   | 0.0   |
| Initial Q Delay(d3),s/veh    | 0.0   | 0.0   | 0.0   | 0.0   | 0.0   | 0.0   | 0.0  | 0.0   | 0.0   | 0.0   | 0.0   | 0.0   |
| %ile BackOfQ(50%),veh/ln     | 8.0   | 15.1  | 6.1   | 4.2   | 0.0   | 24.7  | 19.5   | 7.2   | 7.4   | 0.6   | 7.9   | 0.0   |
| LnGrp Delay(d),s/veh         | 81.3  | 44.3  | 36.5  | 88.6  | 0.0   | 77.6  | 107.0  | 29.7  | 29.8  | 100.1   | 51.8  | 0.0   |
| LnGrp LOS                    | F   | D   | D   | F   |   | E   | F  | C   | C   | F   | D   |   |
| Approach Vol, veh/h          |   | 793   |   |   | 610   |   |  | 882   |   |   | 444   |   |
| Approach Delay, s/veh        |   | 50.6  |   |   | 79.2  |   |  | 61.6  |   |   | 53.0  |   |
| Approach LOS                 |   | D   |   |   | E   |   |  | E   |   |   | D   |   |
| Timer                        | 1   | 2   | 3   | 4   | 5   | 6   | 7  | 8   |   |   |   |   |
| Assigned Phs                 | 1   | 2   | 3   | 4   | 5   | 6   | 7  | 8   |   |   |   |   |
| Phs Duration (G+Y+Rc), s     | 14.5  | 57.2  | 35.0  | 39.1  | 22.1  | 49.5  | 6.8  | 67.3  |   |   |   |   |
| Change Period (Y+Rc), s      | 5.0   | 6.0   | 5.0   | 6.0   | 5.0   | 6.0   | 5.0  | 6.0   |   |   |   |   |
| Max Green Setting (Gmax), s  | 30.0  | 45.0  | 30.0  | 60.0  | 30.0  | 45.0  | 30.0   | 60.0  |   |   |   |   |
| Max Q Clear Time (g_c+I1), s | 9.3   | 30.3  | 32.0  | 17.9  | 16.3  | 42.6  | 3.0  | 16.7  |   |   |   |   |
| Green Ext Time (p_c), s      | 0.4   | 10.4  | 0.0   | 15.2  | 0.8   | 1.0   | 0.0  | 17.0  |   |   |   |   |
| <b>Intersection Summary</b>  |   |   |   |   |   |   |  |   |   |   |   |   |
| HCM 2010 Ctrl Delay          |   |   | 60.9  |   |   |   |  |   |   |   |   |   |
| HCM 2010 LOS                 |   |   | E   |   |   |   |  |   |   |   |   |   |























HCM 2010 Signalized Intersection Summary  
3: West Lane & Hammer Lane























Stockton General Plan  
Existing PM

|                              |  |  |  |  |  |  |  |  |  |  |  |  |
|------------------------------|---|---|---|---|---|---|--|---|---|---|---|---|
| Movement                     | EBL   | EBT   | EBR   | WBL   | WBT   | WBR   | NBL  | NBT   | NBR   | SBL   | SBT   | SBR   |
| Lane Configurations          |  |  |  |  |  |  |  |  |  |  |  |  |
| Traffic Volume (veh/h)       | 428   | 1255  | 180   | 380   | 1227  | 142   | 512  | 752   | 215   | 206   | 608   | 306   |
| Future Volume (veh/h)        | 428   | 1255  | 180   | 380   | 1227  | 142   | 512  | 752   | 215   | 206   | 608   | 306   |
| Number                       | 7   | 4   | 14  | 3   | 8   | 18  | 5  | 2   | 12  | 1   | 6   | 16  |
| Initial Q (Qb), veh          | 0   | 0   | 0   | 0   | 0   | 0   | 0  | 0   | 0   | 0   | 0   | 0   |
| Ped-Bike Adj(A_pbT)          | 1.00  |   | 0.98  | 1.00  |   | 0.98  | 1.00   |   | 0.98  | 1.00  |   | 0.96  |
| Parking Bus, Adj             | 1.00  | 1.00  | 1.00  | 1.00  | 1.00  | 1.00  | 1.00   | 1.00  | 1.00  | 1.00  | 1.00  | 1.00  |
| Adj Sat Flow, veh/h/ln       | 1845  | 1845  | 1845  | 1845  | 1845  | 1845  | 1845   | 1845  | 1845  | 1845  | 1845  | 1845  |
| Adj Flow Rate, veh/h         | 455   | 1335  | 65  | 404   | 1305  | 57  | 545  | 800   | 63  | 219   | 647   | 91  |
| Adj No. of Lanes             | 2   | 4   | 1   | 2   | 4   | 1   | 2  | 4   | 1   | 2   | 4   | 1   |
| Peak Hour Factor             | 0.94  | 0.94  | 0.94  | 0.94  | 0.94  | 0.94  | 0.94   | 0.94  | 0.94  | 0.94  | 0.94  | 0.94  |
| Percent Heavy Veh, %         | 3   | 3   | 3   | 3   | 3   | 3   | 3  | 3   | 3   | 3   | 3   | 3   |
| Cap, veh/h                   | 501   | 2114  | 514   | 454   | 2026  | 490   | 414  | 1934  | 470   | 269   | 1664  | 396   |
| Arrive On Green              | 0.15  | 0.33  | 0.33  | 0.13  | 0.32  | 0.32  | 0.12   | 0.30  | 0.30  | 0.08  | 0.26  | 0.26  |
| Sat Flow, veh/h              | 3408  | 6346  | 1542  | 3408  | 6346  | 1536  | 3408   | 6346  | 1543  | 3408  | 6346  | 1511  |
| Grp Volume(v), veh/h         | 455   | 1335  | 65  | 404   | 1305  | 57  | 545  | 800   | 63  | 219   | 647   | 91  |
| Grp Sat Flow(s),veh/h/ln     | 1704  | 1586  | 1542  | 1704  | 1586  | 1536  | 1704   | 1586  | 1543  | 1704  | 1586  | 1511  |
| Q Serve(g_s), s              | 18.4  | 24.9  | 4.1   | 16.3  | 24.7  | 3.7   | 17.0   | 14.0  | 4.1   | 8.9   | 11.7  | 6.6   |
| Cycle Q Clear(g_c), s        | 18.4  | 24.9  | 4.1   | 16.3  | 24.7  | 3.7   | 17.0   | 14.0  | 4.1   | 8.9   | 11.7  | 6.6   |
| Prop In Lane                 | 1.00  |   | 1.00  | 1.00  |   | 1.00  | 1.00   |   | 1.00  | 1.00  |   | 1.00  |
| Lane Grp Cap(c), veh/h       | 501   | 2114  | 514   | 454   | 2026  | 490   | 414  | 1934  | 470   | 269   | 1664  | 396   |
| V/C Ratio(X)                 | 0.91  | 0.63  | 0.13  | 0.89  | 0.64  | 0.12  | 1.32   | 0.41  | 0.13  | 0.81  | 0.39  | 0.23  |
| Avail Cap(c_a), veh/h        | 536   | 2114  | 514   | 536   | 2026  | 490   | 414  | 1934  | 470   | 414   | 1904  | 453   |
| HCM Platoon Ratio            | 1.00  | 1.00  | 1.00  | 1.00  | 1.00  | 1.00  | 1.00   | 1.00  | 1.00  | 1.00  | 1.00  | 1.00  |
| Upstream Filter(I)           | 1.00  | 1.00  | 1.00  | 1.00  | 1.00  | 1.00  | 1.00   | 1.00  | 1.00  | 1.00  | 1.00  | 1.00  |
| Uniform Delay (d), s/veh     | 58.8  | 39.4  | 32.5  | 59.7  | 40.8  | 33.7  | 61.5   | 38.7  | 35.3  | 63.5  | 42.4  | 40.5  |
| Incr Delay (d2), s/veh       | 17.9  | 1.4   | 0.5   | 13.8  | 1.6   | 0.5   | 158.8  | 0.5   | 0.5   | 3.7   | 0.5   | 1.1   |
| Initial Q Delay(d3),s/veh    | 0.0   | 0.0   | 0.0   | 0.0   | 0.0   | 0.0   | 0.0  | 0.0   | 0.0   | 0.0   | 0.0   | 0.0   |
| %ile BackOfQ(50%),veh/ln     | 9.9   | 11.2  | 1.8   | 8.6   | 11.0  | 1.6   | 17.1   | 6.2   | 1.8   | 4.3   | 5.2   | 2.9   |
| LnGrp Delay(d),s/veh         | 76.6  | 40.9  | 33.0  | 73.5  | 42.4  | 34.2  | 220.3  | 39.2  | 35.7  | 67.2  | 43.0  | 41.6  |
| LnGrp LOS                    | E   | D   | C   | E   | D   | C   | F  | D   | D   | E   | D   | D   |
| Approach Vol, veh/h          |   | 1855  |   |   | 1766  |   |  | 1408  |   |   | 957   |   |
| Approach Delay, s/veh        |   | 49.4  |   |   | 49.3  |   |  | 109.2   |   |   | 48.4  |   |
| Approach LOS                 |   | D   |   |   | D   |   |  | F   |   |   | D   |   |
| Timer                        | 1   | 2   | 3   | 4   | 5   | 6   | 7  | 8   |   |   |   |   |
| Assigned Phs                 | 1   | 2   | 3   | 4   | 5   | 6   | 7  | 8   |   |   |   |   |
| Phs Duration (G+Y+Rc), s     | 16.1  | 48.7  | 23.6  | 51.6  | 22.0  | 42.7  | 25.6   | 49.7  |   |   |   |   |
| Change Period (Y+Rc), s      | 5.0   | 6.0   | 5.0   | 5.0   | 5.0   | 6.0   | 5.0  | 5.0   |   |   |   |   |
| Max Green Setting (Gmax), s  | 17.0  | 42.0  | 22.0  | 38.0  | 17.0  | 42.0  | 22.0   | 38.0  |   |   |   |   |
| Max Q Clear Time (g_c+I1), s | 10.9  | 16.0  | 18.3  | 26.9  | 19.0  | 13.7  | 20.4   | 26.7  |   |   |   |   |
| Green Ext Time (p_c), s      | 0.2   | 20.9  | 0.3   | 11.0  | 0.0   | 21.7  | 0.2  | 11.2  |   |   |   |   |
| <b>Intersection Summary</b>  |   |   |   |   |   |   |  |   |   |   |   |   |
| HCM 2010 Ctrl Delay          |   |   | 63.2  |   |   |   |  |   |   |   |   |   |
| HCM 2010 LOS                 |   |   | E   |   |   |   |  |   |   |   |   |   |

HCM 2010 Signalized Intersection Summary  
4: Holman Road & Hammer Lane





















Stockton General Plan  
Existing PM

|                              |  |  |  |  |  |  |  |  |  |  |  |  |
|------------------------------|---|---|---|---|---|---|--|---|---|---|---|---|
| Movement                     | EBL   | EBT   | EBR   | WBL   | WBT   | WBR   | NBL  | NBT   | NBR   | SBL   | SBT   | SBR   |
| Lane Configurations          |  |  |   |  |  |   |  |  |   |  |  |  |
| Traffic Volume (veh/h)       | 544   | 1275  | 162   | 199   | 1370  | 112   | 308  | 375   | 12  | 277   | 301   | 208   |
| Future Volume (veh/h)        | 544   | 1275  | 162   | 199   | 1370  | 112   | 308  | 375   | 12  | 277   | 301   | 208   |
| Number                       | 5   | 2   | 12  | 1   | 6   | 16  | 7  | 4   | 14  | 3   | 8   | 18  |
| Initial Q (Qb), veh          | 0   | 0   | 0   | 0   | 0   | 0   | 0  | 0   | 0   | 0   | 0   | 0   |
| Ped-Bike Adj(A_pbT)          | 1.00  |   | 0.99  | 1.00  |   | 0.98  | 1.00   |   | 0.99  | 1.00  |   | 0.95  |
| Parking Bus, Adj             | 1.00  | 1.00  | 1.00  | 1.00  | 1.00  | 1.00  | 1.00   | 1.00  | 1.00  | 1.00  | 1.00  | 1.00  |
| Adj Sat Flow, veh/h/ln       | 1845  | 1845  | 1900  | 1845  | 1845  | 1900  | 1845   | 1842  | 1900  | 1845  | 1845  | 1845  |
| Adj Flow Rate, veh/h         | 591   | 1386  | 160   | 216   | 1489  | 112   | 335  | 408   | 10  | 301   | 327   | 35  |
| Adj No. of Lanes             | 2   | 4   | 0   | 2   | 4   | 0   | 2  | 3   | 0   | 2   | 3   | 1   |
| Peak Hour Factor             | 0.92  | 0.92  | 0.92  | 0.92  | 0.92  | 0.92  | 0.92   | 0.92  | 0.92  | 0.92  | 0.92  | 0.92  |
| Percent Heavy Veh, %         | 3   | 3   | 3   | 3   | 3   | 3   | 3  | 3   | 3   | 3   | 3   | 3   |
| Cap, veh/h                   | 1216  | 2915  | 336   | 272   | 1312  | 99  | 389  | 699   | 17  | 357   | 650   | 193   |
| Arrive On Green              | 0.36  | 0.50  | 0.50  | 0.08  | 0.22  | 0.22  | 0.11   | 0.14  | 0.14  | 0.10  | 0.13  | 0.13  |
| Sat Flow, veh/h              | 3408  | 5805  | 669   | 3408  | 6056  | 455   | 3408   | 5048  | 123   | 3408  | 5036  | 1495  |
| Grp Volume(v), veh/h         | 591   | 1136  | 410   | 216   | 1170  | 431   | 335  | 270   | 148   | 301   | 327   | 35  |
| Grp Sat Flow(s),veh/h/ln     | 1704  | 1586  | 1715  | 1704  | 1586  | 1752  | 1704   | 1676  | 1819  | 1704  | 1679  | 1495  |
| Q Serve(g_s), s              | 16.2  | 18.7  | 18.8  | 7.5   | 26.0  | 26.0  | 11.6   | 9.1   | 9.1   | 10.4  | 7.3   | 2.5   |
| Cycle Q Clear(g_c), s        | 16.2  | 18.7  | 18.8  | 7.5   | 26.0  | 26.0  | 11.6   | 9.1   | 9.1   | 10.4  | 7.3   | 2.5   |
| Prop In Lane                 | 1.00  |   | 0.39  | 1.00  |   | 0.26  | 1.00   |   | 0.07  | 1.00  |   | 1.00  |
| Lane Grp Cap(c), veh/h       | 1216  | 2390  | 861   | 272   | 1031  | 380   | 389  | 464   | 252   | 357   | 650   | 193   |
| V/C Ratio(X)                 | 0.49  | 0.48  | 0.48  | 0.80  | 1.13  | 1.14  | 0.86   | 0.58  | 0.59  | 0.84  | 0.50  | 0.18  |
| Avail Cap(c_a), veh/h        | 1216  | 2390  | 861   | 341   | 1031  | 380   | 426  | 810   | 440   | 426   | 1217  | 361   |
| HCM Platoon Ratio            | 1.00  | 1.00  | 1.00  | 1.00  | 1.00  | 1.00  | 1.00   | 1.00  | 1.00  | 1.00  | 1.00  | 1.00  |
| Upstream Filter(I)           | 1.00  | 1.00  | 1.00  | 1.00  | 1.00  | 1.00  | 1.00   | 1.00  | 1.00  | 1.00  | 1.00  | 1.00  |
| Uniform Delay (d), s/veh     | 30.0  | 19.5  | 19.6  | 54.3  | 47.0  | 47.0  | 52.2   | 48.4  | 48.5  | 52.7  | 48.7  | 46.6  |
| Incr Delay (d2), s/veh       | 0.1   | 0.7   | 1.9   | 7.7   | 72.7  | 88.6  | 14.2   | 0.4   | 0.8   | 10.8  | 0.2   | 0.2   |
| Initial Q Delay(d3),s/veh    | 0.0   | 0.0   | 0.0   | 0.0   | 0.0   | 0.0   | 0.0  | 0.0   | 0.0   | 0.0   | 0.0   | 0.0   |
| %ile BackOfQ(50%),veh/ln     | 7.7   | 8.4   | 9.3   | 3.8   | 18.3  | 21.9  | 6.2  | 4.2   | 4.6   | 5.4   | 3.4   | 1.0   |
| LnGrp Delay(d),s/veh         | 30.1  | 20.2  | 21.4  | 62.0  | 119.7   | 135.6   | 66.4   | 48.9  | 49.3  | 63.6  | 48.9  | 46.8  |
| LnGrp LOS                    | C   | C   | C   | E   | F   | F   | E  | D   | D   | E   | D   | D   |
| Approach Vol, veh/h          |   | 2137  |   |   | 1817  |   |  | 753   |   |   | 663   |   |
| Approach Delay, s/veh        |   | 23.2  |   |   | 116.6   |   |  | 56.8  |   |   | 55.4  |   |
| Approach LOS                 |   | C   |   |   | F   |   |  | E   |   |   | E   |   |
| Timer                        | 1   | 2   | 3   | 4   | 5   | 6   | 7  | 8   |   |   |   |   |
| Assigned Phs                 | 1   | 2   | 3   | 4   | 5   | 6   | 7  | 8   |   |   |   |   |
| Phs Duration (G+Y+Rc), s     | 14.6  | 66.3  | 17.6  | 21.6  | 48.8  | 32.0  | 18.7   | 20.5  |   |   |   |   |
| Change Period (Y+Rc), s      | 5.0   | 6.0   | 5.0   | 5.0   | 6.0   | * 6   | 5.0  | 5.0   |   |   |   |   |
| Max Green Setting (Gmax), s  | 12.0  | 43.0  | 15.0  | 29.0  | 29.0  | * 26  | 15.0   | 29.0  |   |   |   |   |
| Max Q Clear Time (g_c+I1), s | 9.5   | 20.8  | 12.4  | 11.1  | 18.2  | 28.0  | 13.6   | 9.3   |   |   |   |   |
| Green Ext Time (p_c), s      | 0.1   | 19.0  | 0.2   | 2.8   | 8.1   | 0.0   | 0.1  | 2.9   |   |   |   |   |
| <b>Intersection Summary</b>  |   |   |   |   |   |   |  |   |   |   |   |   |
| HCM 2010 Ctrl Delay          |   |   | 63.5  |   |   |   |  |   |   |   |   |   |
| HCM 2010 LOS                 |   |   | E   |   |   |   |  |   |   |   |   |   |
| <b>Notes</b>                 |   |   |   |   |   |   |  |   |   |   |   |   |

|                              |  |  |  |  |  |  |   |  |  |  |  |  |
|------------------------------|---|---|---|---|---|---|---|---|---|---|---|---|
| Movement                     | EBL   | EBT   | EBR   | WBL   | WBT   | WBR   | NBL   | NBT   | NBR   | SBL   | SBT   | SBR   |
| Lane Configurations          |   |  |  |  |  |   |  |  |  |  |  |  |
| Traffic Volume (veh/h)       | 34  | 99  | 56  | 731   | 53  | 17  | 64  | 940   | 910   | 34  | 765   | 21  |
| Future Volume (veh/h)        | 34  | 99  | 56  | 731   | 53  | 17  | 64  | 940   | 910   | 34  | 765   | 21  |
| Number                       | 7   | 4   | 14  | 3   | 8   | 18  | 5   | 2   | 12  | 1   | 6   | 16  |
| Initial Q (Qb), veh          | 0   | 0   | 0   | 0   | 0   | 0   | 0   | 0   | 0   | 0   | 0   | 0   |
| Ped-Bike Adj(A_pbT)          | 1.00  |   | 0.99  | 1.00  |   | 1.00  | 1.00  |   | 1.00  | 1.00  |   | 0.96  |
| Parking Bus, Adj             | 1.00  | 1.00  | 1.00  | 1.00  | 1.00  | 1.00  | 1.00  | 1.00  | 1.00  | 1.00  | 1.00  | 1.00  |
| Adj Sat Flow, veh/h/ln       | 1900  | 1845  | 1845  | 1845  | 1842  | 1900  | 1845  | 1845  | 1845  | 1845  | 1845  | 1900  |
| Adj Flow Rate, veh/h         | 36  | 105   | 5   | 818   | 0   | 0   | 68  | 1000  | 0   | 36  | 814   | 20  |
| Adj No. of Lanes             | 0   | 1   | 1   | 2   | 1   | 0   | 1   | 2   | 1   | 1   | 3   | 0   |
| Peak Hour Factor             | 0.94  | 0.94  | 0.94  | 0.94  | 0.94  | 0.94  | 0.94  | 0.94  | 0.94  | 0.94  | 0.94  | 0.94  |
| Percent Heavy Veh, %         | 3   | 3   | 3   | 3   | 3   | 3   | 3   | 3   | 3   | 3   | 3   | 3   |
| Cap, veh/h                   | 43  | 124   | 142   | 921   | 483   | 0   | 345   | 1589  | 711   | 46  | 1431  | 35  |
| Arrive On Green              | 0.09  | 0.09  | 0.09  | 0.26  | 0.00  | 0.00  | 0.20  | 0.45  | 0.00  | 0.03  | 0.28  | 0.28  |
| Sat Flow, veh/h              | 465   | 1356  | 1545  | 3514  | 1842  | 0   | 1757  | 3505  | 1568  | 1757  | 5050  | 124   |
| Grp Volume(v), veh/h         | 141   | 0   | 5   | 818   | 0   | 0   | 68  | 1000  | 0   | 36  | 541   | 293   |
| Grp Sat Flow(s),veh/h/ln     | 1821  | 0   | 1545  | 1757  | 1842  | 0   | 1757  | 1752  | 1568  | 1757  | 1679  | 1816  |
| Q Serve(g_s), s              | 9.1   | 0.0   | 0.4   | 26.9  | 0.0   | 0.0   | 3.9   | 26.2  | 0.0   | 2.4   | 16.5  | 16.6  |
| Cycle Q Clear(g_c), s        | 9.1   | 0.0   | 0.4   | 26.9  | 0.0   | 0.0   | 3.9   | 26.2  | 0.0   | 2.4   | 16.5  | 16.6  |
| Prop In Lane                 | 0.26  |   | 1.00  | 1.00  |   | 0.00  | 1.00  |   | 1.00  | 1.00  |   | 0.07  |
| Lane Grp Cap(c), veh/h       | 167   | 0   | 142   | 921   | 483   | 0   | 345   | 1589  | 711   | 46  | 951   | 515   |
| V/C Ratio(X)                 | 0.84  | 0.00  | 0.04  | 0.89  | 0.00  | 0.00  | 0.20  | 0.63  | 0.00  | 0.79  | 0.57  | 0.57  |
| Avail Cap(c_a), veh/h        | 167   | 0   | 142   | 1200  | 629   | 0   | 345   | 1589  | 711   | 161   | 951   | 515   |
| HCM Platoon Ratio            | 1.00  | 1.00  | 1.00  | 1.00  | 1.00  | 1.00  | 1.00  | 1.00  | 1.00  | 1.00  | 1.00  | 1.00  |
| Upstream Filter(I)           | 1.00  | 0.00  | 1.00  | 1.00  | 0.00  | 0.00  | 1.00  | 1.00  | 0.00  | 1.00  | 1.00  | 1.00  |
| Uniform Delay (d), s/veh     | 53.7  | 0.0   | 49.7  | 42.6  | 0.0   | 0.0   | 40.3  | 25.1  | 0.0   | 58.1  | 36.7  | 36.8  |
| Incr Delay (d2), s/veh       | 29.4  | 0.0   | 0.0   | 6.8   | 0.0   | 0.0   | 0.1   | 1.9   | 0.0   | 10.7  | 2.5   | 4.5   |
| Initial Q Delay(d3),s/veh    | 0.0   | 0.0   | 0.0   | 0.0   | 0.0   | 0.0   | 0.0   | 0.0   | 0.0   | 0.0   | 0.0   | 0.0   |
| %ile BackOfQ(50%),veh/ln     | 6.0   | 0.0   | 0.2   | 13.9  | 0.0   | 0.0   | 1.9   | 13.1  | 0.0   | 1.3   | 8.0   | 9.0   |
| LnGrp Delay(d),s/veh         | 83.1  | 0.0   | 49.7  | 49.4  | 0.0   | 0.0   | 40.4  | 27.0  | 0.0   | 68.8  | 39.2  | 41.3  |
| LnGrp LOS                    | F   |   | D   | D   |   |   | D   | C   |   | E   | D   | D   |
| Approach Vol, veh/h          |   | 146   |   |   | 818   |   |   | 1068  |   |   | 870   |   |
| Approach Delay, s/veh        |   | 81.9  |   |   | 49.4  |   |   | 27.8  |   |   | 41.1  |   |
| Approach LOS                 |   | F   |   |   | D   |   |   | C   |   |   | D   |   |
| Timer                        | 1   | 2   | 3   | 4   | 5   | 6   | 7   | 8   |   |   |   |   |
| Assigned Phs                 | 1   | 2   |   | 4   | 5   | 6   |   | 8   |   |   |   |   |
| Phs Duration (G+Y+Rc), s     | 8.1   | 59.4  |   | 16.0  | 28.5  | 39.0  |   | 36.5  |   |   |   |   |
| Change Period (Y+Rc), s      | 5.0   | 5.0   |   | 5.0   | 5.0   | 5.0   |   | 5.0   |   |   |   |   |
| Max Green Setting (Gmax), s  | 11.0  | 37.0  |   | 11.0  | 14.0  | 34.0  |   | 41.0  |   |   |   |   |
| Max Q Clear Time (g_c+I1), s | 4.4   | 28.2  |   | 11.1  | 5.9   | 18.6  |   | 28.9  |   |   |   |   |
| Green Ext Time (p_c), s      | 0.0   | 6.8   |   | 0.0   | 1.8   | 9.1   |   | 2.6   |   |   |   |   |
| <b>Intersection Summary</b>  |   |   |   |   |   |   |   |   |   |   |   |   |
| HCM 2010 Ctrl Delay          |   |   | 40.6  |   |   |   |   |   |   |   |   |   |
| HCM 2010 LOS                 |   |   | D   |   |   |   |   |   |   |   |   |   |
| <b>Notes</b>                 |   |   |   |   |   |   |   |   |   |   |   |   |

























HCM 2010 Signalized Intersection Summary  
6: Feather River Drive & March Lane

Stockton General Plan  
Existing PM

|                              |  |  |  |  |  |  |   |  |  |  |  |  |
|------------------------------|---|---|---|---|---|---|---|---|---|---|---|---|
| Movement                     | EBL   | EBT   | EBR   | WBL   | WBT   | WBR   | NBL   | NBT   | NBR   | SBL   | SBT   | SBR   |
| Lane Configurations          |  |  |   |  |  |   |  |  |   |  |  |   |
| Traffic Volume (veh/h)       | 79  | 978   | 29  | 324   | 845   | 273   | 39  | 128   | 109   | 409   | 73  | 26  |
| Future Volume (veh/h)        | 79  | 978   | 29  | 324   | 845   | 273   | 39  | 128   | 109   | 409   | 73  | 26  |
| Number                       | 5   | 2   | 12  | 1   | 6   | 16  | 7   | 4   | 14  | 3   | 8   | 18  |
| Initial Q (Qb), veh          | 0   | 0   | 0   | 0   | 0   | 0   | 0   | 0   | 0   | 0   | 0   | 0   |
| Ped-Bike Adj(A_pbT)          | 1.00  |   | 1.00  | 1.00  |   | 1.00  | 1.00  |   | 0.98  | 1.00  |   | 1.00  |
| Parking Bus, Adj             | 1.00  | 1.00  | 1.00  | 1.00  | 1.00  | 1.00  | 1.00  | 1.00  | 1.00  | 1.00  | 1.00  | 1.00  |
| Adj Sat Flow, veh/h/ln       | 1845  | 1845  | 1900  | 1845  | 1845  | 1900  | 1845  | 1845  | 1900  | 1845  | 1845  | 1900  |
| Adj Flow Rate, veh/h         | 88  | 1087  | 30  | 360   | 939   | 255   | 43  | 142   | 95  | 280   | 324   | 26  |
| Adj No. of Lanes             | 1   | 3   | 0   | 1   | 3   | 0   | 1   | 1   | 0   | 1   | 1   | 0   |
| Peak Hour Factor             | 0.90  | 0.90  | 0.90  | 0.90  | 0.90  | 0.90  | 0.90  | 0.90  | 0.90  | 0.90  | 0.90  | 0.90  |
| Percent Heavy Veh, %         | 3   | 3   | 3   | 3   | 3   | 3   | 3   | 3   | 3   | 3   | 3   | 3   |
| Cap, veh/h                   | 176   | 1416  | 39  | 385   | 1578  | 427   | 249   | 145   | 97  | 337   | 323   | 26  |
| Arrive On Green              | 0.10  | 0.28  | 0.28  | 0.22  | 0.40  | 0.40  | 0.14  | 0.14  | 0.14  | 0.19  | 0.19  | 0.19  |
| Sat Flow, veh/h              | 1757  | 5038  | 139   | 1757  | 3945  | 1068  | 1757  | 1021  | 683   | 1757  | 1686  | 135   |
| Grp Volume(v), veh/h         | 88  | 724   | 393   | 360   | 799   | 395   | 43  | 0   | 237   | 280   | 0   | 350   |
| Grp Sat Flow(s),veh/h/ln     | 1757  | 1679  | 1820  | 1757  | 1679  | 1656  | 1757  | 0   | 1705  | 1757  | 0   | 1821  |
| Q Serve(g_s), s              | 5.7   | 23.7  | 23.8  | 24.2  | 22.5  | 22.6  | 2.6   | 0.0   | 16.6  | 18.4  | 0.0   | 23.0  |
| Cycle Q Clear(g_c), s        | 5.7   | 23.7  | 23.8  | 24.2  | 22.5  | 22.6  | 2.6   | 0.0   | 16.6  | 18.4  | 0.0   | 23.0  |
| Prop In Lane                 | 1.00  |   | 0.08  | 1.00  |   | 0.65  | 1.00  |   | 0.40  | 1.00  |   | 0.07  |
| Lane Grp Cap(c), veh/h       | 176   | 943   | 511   | 385   | 1343  | 662   | 249   | 0   | 242   | 337   | 0   | 349   |
| V/C Ratio(X)                 | 0.50  | 0.77  | 0.77  | 0.94  | 0.59  | 0.60  | 0.17  | 0.00  | 0.98  | 0.83  | 0.00  | 1.00  |
| Avail Cap(c_a), veh/h        | 176   | 943   | 511   | 410   | 1343  | 662   | 249   | 0   | 242   | 337   | 0   | 349   |
| HCM Platoon Ratio            | 1.00  | 1.00  | 1.00  | 1.00  | 1.00  | 1.00  | 1.00  | 1.00  | 1.00  | 1.00  | 1.00  | 1.00  |
| Upstream Filter(I)           | 1.00  | 1.00  | 1.00  | 1.00  | 1.00  | 1.00  | 1.00  | 0.00  | 1.00  | 1.00  | 0.00  | 1.00  |
| Uniform Delay (d), s/veh     | 51.2  | 39.5  | 39.6  | 46.0  | 28.3  | 28.4  | 45.3  | 0.0   | 51.3  | 46.6  | 0.0   | 48.5  |
| Incr Delay (d2), s/veh       | 9.9   | 6.0   | 10.6  | 27.2  | 1.9   | 3.9   | 0.1   | 0.0   | 52.3  | 16.0  | 0.0   | 48.9  |
| Initial Q Delay(d3),s/veh    | 0.0   | 0.0   | 0.0   | 0.0   | 0.0   | 0.0   | 0.0   | 0.0   | 0.0   | 0.0   | 0.0   | 0.0   |
| %ile BackOfQ(50%),veh/ln     | 3.2   | 11.7  | 13.4  | 14.6  | 10.8  | 11.0  | 1.3   | 0.0   | 11.3  | 10.4  | 0.0   | 16.3  |
| LnGrp Delay(d),s/veh         | 61.0  | 45.5  | 50.1  | 73.2  | 30.3  | 32.3  | 45.4  | 0.0   | 103.7   | 62.7  | 0.0   | 97.4  |
| LnGrp LOS                    | E   | D   | D   | E   | C   | C   | D   |   | F   | E   |   | F   |
| Approach Vol, veh/h          |   | 1205  |   |   | 1554  |   |   | 280   |   |   | 630   |   |
| Approach Delay, s/veh        |   | 48.2  |   |   | 40.8  |   |   | 94.7  |   |   | 82.0  |   |
| Approach LOS                 |   | D   |   |   | D   |   |   | F   |   |   | F   |   |
| Timer                        | 1   | 2   | 3   | 4   | 5   | 6   | 7   | 8   |   |   |   |   |
| Assigned Phs                 | 1   | 2   |   | 4   | 5   | 6   |   | 8   |   |   |   |   |
| Phs Duration (G+Y+Rc), s     | 31.3  | 38.7  |   | 22.0  | 17.0  | 53.0  |   | 28.0  |   |   |   |   |
| Change Period (Y+Rc), s      | 5.0   | 5.0   |   | 5.0   | 5.0   | 5.0   |   | 5.0   |   |   |   |   |
| Max Green Setting (Gmax), s  | 28.0  | 32.0  |   | 17.0  | 12.0  | 48.0  |   | 23.0  |   |   |   |   |
| Max Q Clear Time (g_c+I1), s | 26.2  | 25.8  |   | 18.6  | 7.7   | 24.6  |   | 25.0  |   |   |   |   |
| Green Ext Time (p_c), s      | 0.1   | 6.1   |   | 0.0   | 0.0   | 22.3  |   | 0.0   |   |   |   |   |
| <b>Intersection Summary</b>  |   |   |   |   |   |   |   |   |   |   |   |   |
| HCM 2010 Ctrl Delay          |   |   |   | 54.4  |   |   |   |   |   |   |   |   |
| HCM 2010 LOS                 |   |   |   | D   |   |   |   |   |   |   |   |   |
| <b>Notes</b>                 |   |   |   |   |   |   |   |   |   |   |   |   |





















HCM 2010 Signalized Intersection Summary  
7: Pacific Avenue & March Lane

Stockton General Plan  
Existing PM

|                              |  |  |  |  |  |  |  |  |  |  |  |  |
|------------------------------|---|---|---|---|---|---|--|---|---|---|---|---|
| Movement                     | EBL   | EBT   | EBR   | WBL   | WBT   | WBR   | NBL  | NBT   | NBR   | SBL   | SBT   | SBR   |
| Lane Configurations          |  |  |  |  |  |  |   |    |    |    |    |    |
| Traffic Volume (veh/h)       | 529   | 1251  | 202   | 294   | 1125  | 178   | 240  | 807   | 100   | 212   | 826   | 301   |
| Future Volume (veh/h)        | 529   | 1251  | 202   | 294   | 1125  | 178   | 240  | 807   | 100   | 212   | 826   | 301   |
| Number                       | 5   | 2   | 12  | 1   | 6   | 16  | 3  | 8   | 18  | 7   | 4   | 14  |
| Initial Q (Qb), veh          | 0   | 0   | 0   | 0   | 0   | 0   | 0  | 0   | 0   | 0   | 0   | 0   |
| Ped-Bike Adj(A_pbT)          | 1.00  |   | 0.99  | 1.00  |   | 0.99  | 1.00   |   | 0.99  | 1.00  |   | 0.97  |
| Parking Bus, Adj             | 1.00  | 1.00  | 1.00  | 1.00  | 1.00  | 1.00  | 1.00   | 1.00  | 1.00  | 1.00  | 1.00  | 1.00  |
| Adj Sat Flow, veh/h/ln       | 1845  | 1845  | 1845  | 1845  | 1845  | 1900  | 1845   | 1845  | 1845  | 1845  | 1845  | 1900  |
| Adj Flow Rate, veh/h         | 545   | 1290  | 106   | 303   | 1160  | 168   | 247  | 832   | 29  | 219   | 852   | 255   |
| Adj No. of Lanes             | 2   | 3   | 1   | 2   | 3   | 0   | 2  | 3   | 1   | 2   | 3   | 0   |
| Peak Hour Factor             | 0.97  | 0.97  | 0.97  | 0.97  | 0.97  | 0.97  | 0.97   | 0.97  | 0.97  | 0.97  | 0.97  | 0.97  |
| Percent Heavy Veh, %         | 3   | 3   | 3   | 3   | 3   | 3   | 3  | 3   | 3   | 3   | 3   | 3   |
| Cap, veh/h                   | 369   | 1469  | 451   | 555   | 1536  | 222   | 445  | 1497  | 462   | 278   | 949   | 282   |
| Arrive On Green              | 0.11  | 0.29  | 0.29  | 0.16  | 0.35  | 0.35  | 0.13   | 0.30  | 0.30  | 0.08  | 0.25  | 0.25  |
| Sat Flow, veh/h              | 3408  | 5036  | 1546  | 3408  | 4436  | 642   | 3408   | 5036  | 1554  | 3408  | 3820  | 1135  |
| Grp Volume(v), veh/h         | 545   | 1290  | 106   | 303   | 878   | 450   | 247  | 832   | 29  | 219   | 748   | 359   |
| Grp Sat Flow(s),veh/h/ln     | 1704  | 1679  | 1546  | 1704  | 1679  | 1721  | 1704   | 1679  | 1554  | 1704  | 1679  | 1598  |
| Q Serve(g_s), s              | 13.0  | 29.3  | 6.3   | 9.8   | 27.8  | 27.8  | 8.2  | 16.7  | 1.0   | 7.6   | 25.9  | 26.1  |
| Cycle Q Clear(g_c), s        | 13.0  | 29.3  | 6.3   | 9.8   | 27.8  | 27.8  | 8.2  | 16.7  | 1.0   | 7.6   | 25.9  | 26.1  |
| Prop In Lane                 | 1.00  |   | 1.00  | 1.00  |   | 0.37  | 1.00   |   | 1.00  | 1.00  |   | 0.71  |
| Lane Grp Cap(c), veh/h       | 369   | 1469  | 451   | 555   | 1162  | 596   | 445  | 1497  | 462   | 278   | 834   | 397   |
| V/C Ratio(X)                 | 1.48  | 0.88  | 0.24  | 0.55  | 0.76  | 0.76  | 0.56   | 0.56  | 0.06  | 0.79  | 0.90  | 0.90  |
| Avail Cap(c_a), veh/h        | 369   | 1469  | 451   | 555   | 1162  | 596   | 625  | 1497  | 462   | 483   | 839   | 400   |
| HCM Platoon Ratio            | 1.00  | 1.00  | 1.00  | 1.00  | 1.00  | 1.00  | 1.00   | 1.00  | 1.00  | 1.00  | 1.00  | 1.00  |
| Upstream Filter(I)           | 1.00  | 1.00  | 1.00  | 1.00  | 1.00  | 1.00  | 1.00   | 1.00  | 1.00  | 1.00  | 1.00  | 1.00  |
| Uniform Delay (d), s/veh     | 53.5  | 40.5  | 32.3  | 46.2  | 34.7  | 34.7  | 48.9   | 35.5  | 12.7  | 54.1  | 43.6  | 43.7  |
| Incr Delay (d2), s/veh       | 228.4   | 7.7   | 1.2   | 0.6   | 4.6   | 8.7   | 0.4  | 1.2   | 0.2   | 1.9   | 13.8  | 25.7  |
| Initial Q Delay(d3),s/veh    | 0.0   | 0.0   | 0.0   | 0.0   | 0.0   | 0.0   | 0.0  | 0.0   | 0.0   | 0.0   | 0.0   | 0.0   |
| %ile BackOfQ(50%),veh/ln     | 17.8  | 14.6  | 2.8   | 4.7   | 13.5  | 14.6  | 3.9  | 7.9   | 0.5   | 3.6   | 13.6  | 14.4  |
| LnGrp Delay(d),s/veh         | 281.9   | 48.2  | 33.5  | 46.8  | 39.3  | 43.4  | 49.3   | 36.7  | 13.0  | 56.0  | 57.5  | 69.4  |
| LnGrp LOS                    | F   | D   | C   | D   | D   | D   | D  | D   | B   | E   | E   | E   |
| Approach Vol, veh/h          |   | 1941  |   |   | 1631  |   |  | 1108  |   |   | 1326  |   |
| Approach Delay, s/veh        |   | 113.0   |   |   | 41.8  |   |  | 38.9  |   |   | 60.5  |   |
| Approach LOS                 |   | F   |   |   | D   |   |  | D   |   |   | E   |   |
| Timer                        | 1   | 2   | 3   | 4   | 5   | 6   | 7  | 8   |   |   |   |   |
| Assigned Phs                 | 1   | 2   | 3   | 4   | 5   | 6   | 7  | 8   |   |   |   |   |
| Phs Duration (G+Y+Rc), s     | 24.5  | 40.0  | 20.7  | 34.8  | 18.0  | 46.5  | 14.8   | 40.7  |   |   |   |   |
| Change Period (Y+Rc), s      | 5.0   | 5.0   | 5.0   | 5.0   | 5.0   | 5.0   | 5.0  | 5.0   |   |   |   |   |
| Max Green Setting (Gmax), s  | 13.0  | 35.0  | 22.0  | 30.0  | 13.0  | 35.0  | 17.0   | 35.0  |   |   |   |   |
| Max Q Clear Time (g_c+I1), s | 11.8  | 31.3  | 10.2  | 28.1  | 15.0  | 29.8  | 9.6  | 18.7  |   |   |   |   |
| Green Ext Time (p_c), s      | 1.1   | 3.4   | 5.5   | 1.6   | 0.0   | 4.7   | 0.2  | 10.0  |   |   |   |   |
| <b>Intersection Summary</b>  |   |   |   |   |   |   |  |   |   |   |   |   |
| HCM 2010 Ctrl Delay          |   |   | 68.4  |   |   |   |  |   |   |   |   |   |
| HCM 2010 LOS                 |   |   | E   |   |   |   |  |   |   |   |   |   |
| <b>Notes</b>                 |   |   |   |   |   |   |  |   |   |   |   |   |























HCM 2010 Signalized Intersection Summary  
8: Pershing Avenue & Country Club Boulevard

Stockton General Plan  
Existing PM

|                              |  |  |  |  |  |  |  |  |  |  |  |  |
|------------------------------|---|---|---|---|---|---|--|---|---|---|---|---|
| Movement                     | EBL   | EBT   | EBR   | WBL   | WBT   | WBR   | NBL  | NBT   | NBR   | SBL   | SBT   | SBR   |
| Lane Configurations          |  |  |   |  |  |   |  |  |   |  |  |   |
| Traffic Volume (veh/h)       | 123   | 61  | 101   | 67  | 128   | 28  | 153  | 1315  | 33  | 31  | 767   | 107   |
| Future Volume (veh/h)        | 123   | 61  | 101   | 67  | 128   | 28  | 153  | 1315  | 33  | 31  | 767   | 107   |
| Number                       | 7   | 4   | 14  | 3   | 8   | 18  | 5  | 2   | 12  | 1   | 6   | 16  |
| Initial Q (Qb), veh          | 0   | 0   | 0   | 0   | 0   | 0   | 0  | 0   | 0   | 0   | 0   | 0   |
| Ped-Bike Adj(A_pbT)          | 1.00  |   | 0.99  | 1.00  |   | 0.98  | 1.00   |   | 1.00  | 1.00  |   | 0.97  |
| Parking Bus, Adj             | 1.00  | 1.00  | 1.00  | 1.00  | 1.00  | 1.00  | 1.00   | 1.00  | 1.00  | 1.00  | 1.00  | 1.00  |
| Adj Sat Flow, veh/h/ln       | 1845  | 1834  | 1900  | 1845  | 1841  | 1900  | 1845   | 1845  | 1900  | 1845  | 1845  | 1900  |
| Adj Flow Rate, veh/h         | 134   | 66  | 53  | 73  | 139   | 23  | 166  | 1429  | 35  | 34  | 834   | 109   |
| Adj No. of Lanes             | 1   | 1   | 0   | 1   | 1   | 0   | 1  | 2   | 0   | 1   | 2   | 0   |
| Peak Hour Factor             | 0.92  | 0.92  | 0.92  | 0.92  | 0.92  | 0.92  | 0.92   | 0.92  | 0.92  | 0.92  | 0.92  | 0.92  |
| Percent Heavy Veh, %         | 3   | 3   | 3   | 3   | 3   | 3   | 3  | 3   | 3   | 3   | 3   | 3   |
| Cap, veh/h                   | 219   | 198   | 159   | 249   | 324   | 54  | 193  | 2236  | 55  | 43  | 1721  | 225   |
| Arrive On Green              | 0.21  | 0.21  | 0.21  | 0.21  | 0.21  | 0.21  | 0.11   | 0.64  | 0.64  | 0.02  | 0.55  | 0.55  |
| Sat Flow, veh/h              | 1203  | 940   | 754   | 1250  | 1536  | 254   | 1757   | 3496  | 86  | 1757  | 3106  | 406   |
| Grp Volume(v), veh/h         | 134   | 0   | 119   | 73  | 0   | 162   | 166  | 716   | 748   | 34  | 470   | 473   |
| Grp Sat Flow(s),veh/h/ln     | 1203  | 0   | 1694  | 1250  | 0   | 1790  | 1757   | 1752  | 1829  | 1757  | 1752  | 1760  |
| Q Serve(g_s), s              | 13.0  | 0.0   | 7.2   | 6.3   | 0.0   | 9.4   | 11.1   | 29.8  | 29.9  | 2.3   | 19.6  | 19.6  |
| Cycle Q Clear(g_c), s        | 22.5  | 0.0   | 7.2   | 13.5  | 0.0   | 9.4   | 11.1   | 29.8  | 29.9  | 2.3   | 19.6  | 19.6  |
| Prop In Lane                 | 1.00  |   | 0.45  | 1.00  |   | 0.14  | 1.00   |   | 0.05  | 1.00  |   | 0.23  |
| Lane Grp Cap(c), veh/h       | 219   | 0   | 357   | 249   | 0   | 378   | 193  | 1121  | 1170  | 43  | 971   | 975   |
| V/C Ratio(X)                 | 0.61  | 0.00  | 0.33  | 0.29  | 0.00  | 0.43  | 0.86   | 0.64  | 0.64  | 0.79  | 0.48  | 0.48  |
| Avail Cap(c_a), veh/h        | 266   | 0   | 424   | 298   | 0   | 448   | 278  | 1121  | 1170  | 220   | 971   | 975   |
| HCM Platoon Ratio            | 1.00  | 1.00  | 1.00  | 1.00  | 1.00  | 1.00  | 1.00   | 1.00  | 1.00  | 1.00  | 1.00  | 1.00  |
| Upstream Filter(I)           | 1.00  | 0.00  | 1.00  | 1.00  | 0.00  | 1.00  | 1.00   | 1.00  | 1.00  | 1.00  | 1.00  | 1.00  |
| Uniform Delay (d), s/veh     | 50.8  | 0.0   | 40.2  | 45.9  | 0.0   | 41.1  | 52.5   | 13.2  | 13.2  | 58.2  | 16.3  | 16.3  |
| Incr Delay (d2), s/veh       | 1.1   | 0.0   | 0.2   | 0.2   | 0.0   | 0.3   | 12.3   | 2.8   | 2.7   | 11.4  | 1.7   | 1.7   |
| Initial Q Delay(d3),s/veh    | 0.0   | 0.0   | 0.0   | 0.0   | 0.0   | 0.0   | 0.0  | 0.0   | 0.0   | 0.0   | 0.0   | 0.0   |
| %ile BackOfQ(50%),veh/ln     | 4.4   | 0.0   | 3.4   | 2.2   | 0.0   | 4.7   | 6.1  | 15.2  | 15.8  | 1.3   | 9.9   | 9.9   |
| LnGrp Delay(d),s/veh         | 51.9  | 0.0   | 40.4  | 46.1  | 0.0   | 41.4  | 64.8   | 16.0  | 15.9  | 69.6  | 18.0  | 18.0  |
| LnGrp LOS                    | D   |   | D   | D   |   | D   | E  | B   | B   | E   | B   | B   |
| Approach Vol, veh/h          |   | 253   |   |   | 235   |   |  | 1630  |   |   | 977   |   |
| Approach Delay, s/veh        |   | 46.5  |   |   | 42.8  |   |  | 20.9  |   |   | 19.8  |   |
| Approach LOS                 |   | D   |   |   | D   |   |  | C   |   |   | B   |   |
| Timer                        | 1   | 2   | 3   | 4   | 5   | 6   | 7  | 8   |   |   |   |   |
| Assigned Phs                 | 1   | 2   |   | 4   | 5   | 6   |  | 8   |   |   |   |   |
| Phs Duration (G+Y+Rc), s     | 7.9   | 81.8  |   | 30.3  | 18.2  | 71.5  |  | 30.3  |   |   |   |   |
| Change Period (Y+Rc), s      | 5.0   | 5.0   |   | 5.0   | 5.0   | 5.0   |  | 5.0   |   |   |   |   |
| Max Green Setting (Gmax), s  | 15.0  | 60.0  |   | 30.0  | 19.0  | 56.0  |  | 30.0  |   |   |   |   |
| Max Q Clear Time (g_c+I1), s | 4.3   | 31.9  |   | 24.5  | 13.1  | 21.6  |  | 15.5  |   |   |   |   |
| Green Ext Time (p_c), s      | 0.0   | 27.2  |   | 0.8   | 0.1   | 33.1  |  | 1.4   |   |   |   |   |
| <b>Intersection Summary</b>  |   |   |   |   |   |   |  |   |   |   |   |   |
| HCM 2010 Ctrl Delay          |   |   | 24.3  |   |   |   |  |   |   |   |   |   |
| HCM 2010 LOS                 |   |   | C   |   |   |   |  |   |   |   |   |   |



















HCM 2010 Signalized Intersection Summary  
9: El Dorado Street & Alpine Avenue

Stockton General Plan  
Existing PM

|                              |  |  |  |  |  |  |  |  |  |  |  |  |
|------------------------------|---|---|---|---|---|---|--|---|---|---|---|---|
| Movement                     | EBL   | EBT   | EBR   | WBL   | WBT   | WBR   | NBL  | NBT   | NBR   | SBL   | SBT   | SBR   |
| Lane Configurations          |  |  |   |  |  |  |  |  |   |  |  |  |
| Traffic Volume (veh/h)       | 75  | 366   | 31  | 122   | 526   | 305   | 93   | 1257  | 105   | 167   | 636   | 58  |
| Future Volume (veh/h)        | 75  | 366   | 31  | 122   | 526   | 305   | 93   | 1257  | 105   | 167   | 636   | 58  |
| Number                       | 7   | 4   | 14  | 3   | 8   | 18  | 1  | 6   | 16  | 5   | 2   | 12  |
| Initial Q (Qb), veh          | 0   | 0   | 0   | 0   | 0   | 0   | 0  | 0   | 0   | 0   | 0   | 0   |
| Ped-Bike Adj(A_pbT)          | 1.00  |   | 0.99  | 1.00  |   | 0.99  | 1.00   |   | 0.99  | 1.00  |   | 1.00  |
| Parking Bus, Adj             | 1.00  | 1.00  | 1.00  | 1.00  | 1.00  | 1.00  | 1.00   | 1.00  | 1.00  | 1.00  | 1.00  | 1.00  |
| Adj Sat Flow, veh/h/ln       | 1845  | 1845  | 1900  | 1845  | 1845  | 1845  | 1845   | 1845  | 1900  | 1845  | 1845  | 1845  |
| Adj Flow Rate, veh/h         | 81  | 394   | 28  | 131   | 566   | 131   | 100  | 1352  | 108   | 180   | 684   | 30  |
| Adj No. of Lanes             | 1   | 2   | 0   | 1   | 2   | 1   | 1  | 2   | 0   | 1   | 2   | 1   |
| Peak Hour Factor             | 0.93  | 0.93  | 0.93  | 0.93  | 0.93  | 0.93  | 0.93   | 0.93  | 0.93  | 0.93  | 0.93  | 0.93  |
| Percent Heavy Veh, %         | 3   | 3   | 3   | 3   | 3   | 3   | 3  | 3   | 3   | 3   | 3   | 3   |
| Cap, veh/h                   | 102   | 557   | 39  | 122   | 628   | 277   | 273  | 1647  | 131   | 189   | 1591  | 711   |
| Arrive On Green              | 0.06  | 0.17  | 0.17  | 0.07  | 0.18  | 0.18  | 0.16   | 0.50  | 0.50  | 0.11  | 0.45  | 0.45  |
| Sat Flow, veh/h              | 1757  | 3319  | 235   | 1757  | 3505  | 1545  | 1757   | 3285  | 261   | 1757  | 3505  | 1566  |
| Grp Volume(v), veh/h         | 81  | 207   | 215   | 131   | 566   | 131   | 100  | 719   | 741   | 180   | 684   | 30  |
| Grp Sat Flow(s),veh/h/ln     | 1757  | 1752  | 1802  | 1757  | 1752  | 1545  | 1757   | 1752  | 1794  | 1757  | 1752  | 1566  |
| Q Serve(g_s), s              | 5.9   | 14.5  | 14.6  | 9.0   | 20.5  | 7.1   | 6.6  | 45.1  | 45.6  | 13.2  | 17.2  | 1.0   |
| Cycle Q Clear(g_c), s        | 5.9   | 14.5  | 14.6  | 9.0   | 20.5  | 7.1   | 6.6  | 45.1  | 45.6  | 13.2  | 17.2  | 1.0   |
| Prop In Lane                 | 1.00  |   | 0.13  | 1.00  |   | 1.00  | 1.00   |   | 0.15  | 1.00  |   | 1.00  |
| Lane Grp Cap(c), veh/h       | 102   | 294   | 303   | 122   | 628   | 277   | 273  | 878   | 899   | 189   | 1591  | 711   |
| V/C Ratio(X)                 | 0.80  | 0.70  | 0.71  | 1.08  | 0.90  | 0.47  | 0.37   | 0.82  | 0.82  | 0.95  | 0.43  | 0.04  |
| Avail Cap(c_a), veh/h        | 176   | 377   | 388   | 122   | 647   | 285   | 273  | 878   | 899   | 189   | 1591  | 711   |
| HCM Platoon Ratio            | 1.00  | 1.00  | 1.00  | 1.00  | 1.00  | 1.00  | 1.00   | 1.00  | 1.00  | 1.00  | 1.00  | 1.00  |
| Upstream Filter(I)           | 1.00  | 1.00  | 1.00  | 1.00  | 1.00  | 1.00  | 1.00   | 1.00  | 1.00  | 1.00  | 1.00  | 1.00  |
| Uniform Delay (d), s/veh     | 60.5  | 51.0  | 51.1  | 60.5  | 52.2  | 24.6  | 49.2   | 27.4  | 27.5  | 57.7  | 24.1  | 10.6  |
| Incr Delay (d2), s/veh       | 5.3   | 2.4   | 2.5   | 103.8   | 15.0  | 0.5   | 0.3  | 8.4   | 8.5   | 50.9  | 0.9   | 0.1   |
| Initial Q Delay(d3),s/veh    | 0.0   | 0.0   | 0.0   | 0.0   | 0.0   | 0.0   | 0.0  | 0.0   | 0.0   | 0.0   | 0.0   | 0.0   |
| %ile BackOfQ(50%),veh/ln     | 3.0   | 7.2   | 7.5   | 7.9   | 11.3  | 3.0   | 3.2  | 23.8  | 24.6  | 9.1   | 8.5   | 0.5   |
| LnGrp Delay(d),s/veh         | 65.7  | 53.5  | 53.6  | 164.3   | 67.2  | 25.1  | 49.5   | 35.8  | 36.0  | 108.6   | 24.9  | 10.7  |
| LnGrp LOS                    | E   | D   | D   | F   | E   | C   | D  | D   | D   | F   | C   | B   |
| Approach Vol, veh/h          |   | 503   |   |   | 828   |   |  | 1560  |   |   | 894   |   |
| Approach Delay, s/veh        |   | 55.5  |   |   | 75.9  |   |  | 36.8  |   |   | 41.3  |   |
| Approach LOS                 |   | E   |   |   | E   |   |  | D   |   |   | D   |   |
| Timer                        | 1   | 2   | 3   | 4   | 5   | 6   | 7  | 8   |   |   |   |   |
| Assigned Phs                 | 1   | 2   | 3   | 4   | 5   | 6   | 7  | 8   |   |   |   |   |
| Phs Duration (G+Y+Rc), s     | 25.2  | 64.0  | 14.0  | 26.8  | 19.0  | 70.2  | 12.5   | 28.3  |   |   |   |   |
| Change Period (Y+Rc), s      | 5.0   | 5.0   | 5.0   | 5.0   | 5.0   | 5.0   | 5.0  | 5.0   |   |   |   |   |
| Max Green Setting (Gmax), s  | 14.0  | 59.0  | 9.0   | 28.0  | 14.0  | 59.0  | 13.0   | 24.0  |   |   |   |   |
| Max Q Clear Time (g_c+I1), s | 8.6   | 19.2  | 11.0  | 16.6  | 15.2  | 47.6  | 7.9  | 22.5  |   |   |   |   |
| Green Ext Time (p_c), s      | 5.0   | 13.6  | 0.0   | 3.5   | 0.0   | 10.3  | 0.0  | 0.7   |   |   |   |   |
| <b>Intersection Summary</b>  |   |   |   |   |   |   |  |   |   |   |   |   |
| HCM 2010 Ctrl Delay          |   |   | 48.9  |   |   |   |  |   |   |   |   |   |
| HCM 2010 LOS                 |   |   | D   |   |   |   |  |   |   |   |   |   |
| <b>Notes</b>                 |   |   |   |   |   |   |  |   |   |   |   |   |

HCM 2010 Signalized Intersection Summary  
 10: Pacific Avenue & Harding Way























Stockton General Plan  
 Existing PM

|                              |  |  |  |  |  |  |  |  |  |  |  |  |
|------------------------------|---|---|---|---|---|---|--|---|---|---|---|---|
| Movement                     | EBL   | EBT   | EBR   | WBL   | WBT   | WBR   | NBL  | NBT   | NBR   | SBL   | SBT   | SBR   |
| Lane Configurations          |   |  |   |   |  |  |  |  |  |  |  |   |
| Traffic Volume (veh/h)       | 104   | 352   | 12  | 28  | 426   | 318   | 15   | 157   | 50  | 317   | 77  | 112   |
| Future Volume (veh/h)        | 104   | 352   | 12  | 28  | 426   | 318   | 15   | 157   | 50  | 317   | 77  | 112   |
| Number                       | 5   | 2   | 12  | 1   | 6   | 16  | 3  | 8   | 18  | 7   | 4   | 14  |
| Initial Q (Qb), veh          | 0   | 0   | 0   | 0   | 0   | 0   | 0  | 0   | 0   | 0   | 0   | 0   |
| Ped-Bike Adj(A_pbT)          | 1.00  |   | 0.98  | 1.00  |   | 0.98  | 1.00   |   | 0.99  | 1.00  |   | 1.00  |
| Parking Bus, Adj             | 1.00  | 1.00  | 0.88  | 1.00  | 1.00  | 1.00  | 1.00   | 1.00  | 1.00  | 1.00  | 1.00  | 1.00  |
| Adj Sat Flow, veh/h/ln       | 1900  | 1845  | 1900  | 1900  | 1844  | 1845  | 1900   | 1845  | 1845  | 1845  | 1812  | 1900  |
| Adj Flow Rate, veh/h         | 121   | 409   | 14  | 33  | 495   | 140   | 17   | 183   | 10  | 230   | 285   | 0   |
| Adj No. of Lanes             | 0   | 2   | 0   | 0   | 2   | 1   | 0  | 1   | 1   | 1   | 1   | 0   |
| Peak Hour Factor             | 0.86  | 0.86  | 0.86  | 0.86  | 0.86  | 0.86  | 0.86   | 0.86  | 0.86  | 0.86  | 0.86  | 0.86  |
| Percent Heavy Veh, %         | 3   | 3   | 3   | 3   | 3   | 3   | 3  | 3   | 3   | 3   | 9   | 9   |
| Cap, veh/h                   | 253   | 893   | 32  | 107   | 1465  | 710   | 23   | 244   | 224   | 384   | 396   | 0   |
| Arrive On Green              | 0.46  | 0.46  | 0.46  | 0.46  | 0.46  | 0.46  | 0.14   | 0.14  | 0.14  | 0.22  | 0.22  | 0.00  |
| Sat Flow, veh/h              | 415   | 1942  | 70  | 130   | 3185  | 1544  | 156  | 1681  | 1548  | 1757  | 1812  | 0   |
| Grp Volume(v), veh/h         | 253   | 0   | 291   | 276   | 252   | 140   | 200  | 0   | 10  | 230   | 285   | 0   |
| Grp Sat Flow(s),veh/h/ln     | 972   | 0   | 1455  | 1721  | 1594  | 1544  | 1837   | 0   | 1548  | 1757  | 1812  | 0   |
| Q Serve(g_s), s              | 11.3  | 0.0   | 11.5  | 0.0   | 8.6   | 4.6   | 8.9  | 0.0   | 0.5   | 10.0  | 12.4  | 0.0   |
| Cycle Q Clear(g_c), s        | 20.0  | 0.0   | 11.5  | 8.1   | 8.6   | 4.6   | 8.9  | 0.0   | 0.5   | 10.0  | 12.4  | 0.0   |
| Prop In Lane                 | 0.48  |   | 0.05  | 0.12  |   | 1.00  | 0.08   |   | 1.00  | 1.00  |   | 0.00  |
| Lane Grp Cap(c), veh/h       | 510   | 0   | 669   | 839   | 733   | 710   | 266  | 0   | 224   | 384   | 396   | 0   |
| V/C Ratio(X)                 | 0.50  | 0.00  | 0.43  | 0.33  | 0.34  | 0.20  | 0.75   | 0.00  | 0.04  | 0.60  | 0.72  | 0.00  |
| Avail Cap(c_a), veh/h        | 510   | 0   | 669   | 839   | 733   | 710   | 475  | 0   | 401   | 517   | 533   | 0   |
| HCM Platoon Ratio            | 1.00  | 1.00  | 1.00  | 1.00  | 1.00  | 1.00  | 1.00   | 1.00  | 1.00  | 1.00  | 1.00  | 1.00  |
| Upstream Filter(I)           | 1.00  | 0.00  | 1.00  | 1.00  | 1.00  | 1.00  | 1.00   | 0.00  | 1.00  | 1.00  | 1.00  | 0.00  |
| Uniform Delay (d), s/veh     | 18.7  | 0.0   | 15.5  | 14.6  | 14.7  | 13.6  | 34.9   | 0.0   | 31.3  | 29.8  | 30.8  | 0.0   |
| Incr Delay (d2), s/veh       | 3.4   | 0.0   | 2.1   | 1.0   | 1.3   | 0.6   | 4.3  | 0.0   | 0.1   | 5.3   | 8.7   | 0.0   |
| Initial Q Delay(d3),s/veh    | 0.0   | 0.0   | 0.0   | 0.0   | 0.0   | 0.0   | 0.0  | 0.0   | 0.0   | 0.0   | 0.0   | 0.0   |
| %ile BackOfQ(50%),veh/ln     | 5.1   | 0.0   | 5.0   | 4.3   | 4.0   | 2.1   | 4.8  | 0.0   | 0.2   | 5.4   | 7.1   | 0.0   |
| LnGrp Delay(d),s/veh         | 22.1  | 0.0   | 17.6  | 15.6  | 16.0  | 14.3  | 39.1   | 0.0   | 31.4  | 35.2  | 39.5  | 0.0   |
| LnGrp LOS                    | C   |   | B   | B   | B   | B   | D  |   | C   | D   | D   |   |
| Approach Vol, veh/h          |   | 544   |   |   | 668   |   |  | 210   |   |   | 515   |   |
| Approach Delay, s/veh        |   | 19.7  |   |   | 15.5  |   |  | 38.8  |   |   | 37.6  |   |
| Approach LOS                 |   | B   |   |   | B   |   |  | D   |   |   | D   |   |
| Timer                        | 1   | 2   | 3   | 4   | 5   | 6   | 7  | 8   |   |   |   |   |
| Assigned Phs                 |   | 2   |   | 4   |   | 6   |  | 8   |   |   |   |   |
| Phs Duration (G+Y+Rc), s     |   | 44.1  |   | 23.6  |   | 44.1  |  | 17.3  |   |   |   |   |
| Change Period (Y+Rc), s      |   | 5.0   |   | 5.0   |   | 5.0   |  | 5.0   |   |   |   |   |
| Max Green Setting (Gmax), s  |   | 23.0  |   | 25.0  |   | 23.0  |  | 22.0  |   |   |   |   |
| Max Q Clear Time (g_c+I1), s |   | 22.0  |   | 14.4  |   | 10.6  |  | 10.9  |   |   |   |   |
| Green Ext Time (p_c), s      |   | 0.6   |   | 4.1   |   | 4.3   |  | 0.8   |   |   |   |   |
| <b>Intersection Summary</b>  |   |   |   |   |   |   |  |   |   |   |   |   |
| HCM 2010 Ctrl Delay          |   |   | 25.1  |   |   |   |  |   |   |   |   |   |
| HCM 2010 LOS                 |   |   | C   |   |   |   |  |   |   |   |   |   |
| <b>Notes</b>                 |   |   |   |   |   |   |  |   |   |   |   |   |

























HCM 2010 Signalized Intersection Summary  
 11: Airport Way/West Lane & Harding Way

Stockton General Plan  
 Existing PM

























|                              |  |  |  |  |  |  |  |  |  |  |  |  |
|------------------------------|---|---|---|---|---|---|--|---|---|---|---|---|
| Movement                     | EBL   | EBT   | EBR   | WBL   | WBT   | WBR   | NBL  | NBT   | NBR   | SBL   | SBT   | SBR   |
| Lane Configurations          |  |  |  |  |  |   |  |  |   |  |  |  |
| Traffic Volume (veh/h)       | 189   | 659   | 109   | 26  | 467   | 114   | 140  | 736   | 62  | 160   | 554   | 152   |
| Future Volume (veh/h)        | 189   | 659   | 109   | 26  | 467   | 114   | 140  | 736   | 62  | 160   | 554   | 152   |
| Number                       | 3   | 8   | 18  | 7   | 4   | 14  | 5  | 2   | 12  | 1   | 6   | 16  |
| Initial Q (Qb), veh          | 0   | 0   | 0   | 0   | 0   | 0   | 0  | 0   | 0   | 0   | 0   | 0   |
| Ped-Bike Adj(A_pbT)          | 1.00  |   | 0.98  | 1.00  |   | 0.95  | 1.00   |   | 0.98  | 1.00  |   | 0.99  |
| Parking Bus, Adj             | 1.00  | 1.00  | 1.00  | 1.00  | 1.00  | 1.00  | 1.00   | 1.00  | 1.00  | 1.00  | 1.00  | 1.00  |
| Adj Sat Flow, veh/h/ln       | 1845  | 1845  | 1845  | 1845  | 1806  | 1900  | 1827   | 1839  | 1900  | 1792  | 1845  | 1845  |
| Adj Flow Rate, veh/h         | 205   | 716   | 50  | 28  | 508   | 112   | 152  | 800   | 63  | 174   | 602   | 64  |
| Adj No. of Lanes             | 1   | 2   | 1   | 1   | 2   | 0   | 1  | 2   | 0   | 1   | 2   | 1   |
| Peak Hour Factor             | 0.92  | 0.92  | 0.92  | 0.92  | 0.92  | 0.92  | 0.92   | 0.92  | 0.92  | 0.92  | 0.92  | 0.92  |
| Percent Heavy Veh, %         | 3   | 3   | 3   | 3   | 5   | 5   | 4  | 3   | 3   | 6   | 3   | 3   |
| Cap, veh/h                   | 235   | 1326  | 581   | 36  | 734   | 161   | 180  | 1025  | 81  | 202   | 1146  | 506   |
| Arrive On Green              | 0.13  | 0.38  | 0.38  | 0.02  | 0.27  | 0.27  | 0.10   | 0.31  | 0.31  | 0.12  | 0.33  | 0.33  |
| Sat Flow, veh/h              | 1757  | 3505  | 1535  | 1757  | 2770  | 607   | 1740   | 3278  | 258   | 1707  | 3505  | 1547  |
| Grp Volume(v), veh/h         | 205   | 716   | 50  | 28  | 313   | 307   | 152  | 426   | 437   | 174   | 602   | 64  |
| Grp Sat Flow(s),veh/h/ln     | 1757  | 1752  | 1535  | 1757  | 1716  | 1660  | 1740   | 1747  | 1789  | 1707  | 1752  | 1547  |
| Q Serve(g_s), s              | 13.4  | 18.7  | 2.5   | 1.9   | 19.3  | 19.5  | 10.1   | 26.0  | 26.0  | 11.7  | 16.4  | 3.4   |
| Cycle Q Clear(g_c), s        | 13.4  | 18.7  | 2.5   | 1.9   | 19.3  | 19.5  | 10.1   | 26.0  | 26.0  | 11.7  | 16.4  | 3.4   |
| Prop In Lane                 | 1.00  |   | 1.00  | 1.00  |   | 0.37  | 1.00   |   | 0.14  | 1.00  |   | 1.00  |
| Lane Grp Cap(c), veh/h       | 235   | 1326  | 581   | 36  | 455   | 440   | 180  | 546   | 559   | 202   | 1146  | 506   |
| V/C Ratio(X)                 | 0.87  | 0.54  | 0.09  | 0.78  | 0.69  | 0.70  | 0.84   | 0.78  | 0.78  | 0.86  | 0.53  | 0.13  |
| Avail Cap(c_a), veh/h        | 599   | 1495  | 655   | 240   | 468   | 453   | 519  | 566   | 580   | 350   | 1146  | 506   |
| HCM Platoon Ratio            | 1.00  | 1.00  | 1.00  | 1.00  | 1.00  | 1.00  | 1.00   | 1.00  | 1.00  | 1.00  | 1.00  | 1.00  |
| Upstream Filter(I)           | 1.00  | 1.00  | 1.00  | 1.00  | 1.00  | 1.00  | 1.00   | 1.00  | 1.00  | 1.00  | 1.00  | 1.00  |
| Uniform Delay (d), s/veh     | 49.8  | 28.5  | 23.4  | 57.2  | 38.7  | 38.8  | 51.6   | 36.6  | 36.6  | 50.8  | 32.1  | 27.7  |
| Incr Delay (d2), s/veh       | 4.0   | 1.2   | 0.2   | 12.7  | 7.2   | 7.7   | 4.0  | 9.6   | 9.4   | 4.2   | 1.4   | 0.4   |
| Initial Q Delay(d3),s/veh    | 0.0   | 0.0   | 0.0   | 0.0   | 0.0   | 0.0   | 0.0  | 0.0   | 0.0   | 0.0   | 0.0   | 0.0   |
| %ile BackOfQ(50%),veh/ln     | 6.8   | 9.3   | 1.1   | 1.0   | 10.0  | 9.9   | 5.1  | 14.0  | 14.3  | 5.8   | 8.2   | 1.5   |
| LnGrp Delay(d),s/veh         | 53.8  | 29.7  | 23.6  | 69.9  | 45.9  | 46.5  | 55.6   | 46.2  | 46.0  | 55.0  | 33.4  | 28.1  |
| LnGrp LOS                    | D   | C   | C   | E   | D   | D   | E  | D   | D   | D   | C   | C   |
| Approach Vol, veh/h          |   | 971   |   |   | 648   |   |  | 1015  |   |   | 840   |   |
| Approach Delay, s/veh        |   | 34.5  |   |   | 47.2  |   |  | 47.5  |   |   | 37.5  |   |
| Approach LOS                 |   | C   |   |   | D   |   |  | D   |   |   | D   |   |
| Timer                        | 1   | 2   | 3   | 4   | 5   | 6   | 7  | 8   |   |   |   |   |
| Assigned Phs                 | 1   | 2   | 3   | 4   | 5   | 6   | 7  | 8   |   |   |   |   |
| Phs Duration (G+Y+Rc), s     | 18.8  | 41.6  | 20.7  | 36.1  | 17.2  | 43.3  | 7.4  | 49.3  |   |   |   |   |
| Change Period (Y+Rc), s      | 5.0   | 5.0   | 5.0   | 5.0   | 5.0   | 5.0   | 5.0  | 5.0   |   |   |   |   |
| Max Green Setting (Gmax), s  | 24.0  | 38.0  | 40.0  | 32.0  | 35.0  | 38.0  | 16.0   | 50.0  |   |   |   |   |
| Max Q Clear Time (g_c+I1), s | 13.7  | 28.0  | 15.4  | 21.5  | 12.1  | 18.4  | 3.9  | 20.7  |   |   |   |   |
| Green Ext Time (p_c), s      | 0.2   | 8.6   | 0.3   | 9.0   | 0.2   | 16.3  | 0.0  | 21.5  |   |   |   |   |
| <b>Intersection Summary</b>  |   |   |   |   |   |   |  |   |   |   |   |   |
| HCM 2010 Ctrl Delay          |   |   | 41.4  |   |   |   |  |   |   |   |   |   |
| HCM 2010 LOS                 |   |   | D   |   |   |   |  |   |   |   |   |   |

HCM 2010 Signalized Intersection Summary  
 12: Fresno Avenue & Charter Way

|                              |  |  |  |  |  |  |   |  |  |  |  |  |
|------------------------------|---|---|---|---|---|---|---|---|---|---|---|---|
| Movement                     | EBL   | EBT   | EBR   | WBL   | WBT   | WBR   | NBL   | NBT   | NBR   | SBL   | SBT   | SBR   |
| Lane Configurations          |  |  |   |  |  |  |  |  |   |  |  |  |
| Traffic Volume (veh/h)       | 444   | 542   | 129   | 146   | 358   | 67  | 8   | 104   | 58  | 82  | 136   | 107   |
| Future Volume (veh/h)        | 444   | 542   | 129   | 146   | 358   | 67  | 8   | 104   | 58  | 82  | 136   | 107   |
| Number                       | 5   | 2   | 12  | 1   | 6   | 16  | 3   | 8   | 18  | 7   | 4   | 14  |
| Initial Q (Qb), veh          | 0   | 0   | 0   | 0   | 0   | 0   | 0   | 0   | 0   | 0   | 0   | 0   |
| Ped-Bike Adj(A_pbT)          | 1.00  |   | 1.00  | 1.00  |   | 1.00  | 1.00  |   | 0.97  | 1.00  |   | 0.97  |
| Parking Bus, Adj             | 1.00  | 1.00  | 1.00  | 1.00  | 1.00  | 1.00  | 1.00  | 1.00  | 1.00  | 1.00  | 1.00  | 1.00  |
| Adj Sat Flow, veh/h/ln       | 1810  | 1723  | 1900  | 1845  | 1727  | 1484  | 1845  | 1832  | 1900  | 1473  | 1845  | 1845  |
| Adj Flow Rate, veh/h         | 462   | 565   | 0   | 152   | 373   | 18  | 8   | 108   | 46  | 85  | 142   | 28  |
| Adj No. of Lanes             | 1   | 1   | 0   | 1   | 1   | 1   | 1   | 1   | 0   | 1   | 1   | 1   |
| Peak Hour Factor             | 0.96  | 0.96  | 0.96  | 0.96  | 0.96  | 0.96  | 0.96  | 0.96  | 0.96  | 0.96  | 0.96  | 0.96  |
| Percent Heavy Veh, %         | 5   | 12  | 12  | 3   | 10  | 28  | 3   | 3   | 3   | 29  | 3   | 3   |
| Cap, veh/h                   | 508   | 760   | 0   | 203   | 415   | 304   | 39  | 155   | 66  | 161   | 408   | 338   |
| Arrive On Green              | 0.29  | 0.44  | 0.00  | 0.12  | 0.24  | 0.24  | 0.02  | 0.13  | 0.13  | 0.11  | 0.22  | 0.22  |
| Sat Flow, veh/h              | 1723  | 1723  | 0   | 1757  | 1727  | 1262  | 1757  | 1206  | 514   | 1403  | 1845  | 1529  |
| Grp Volume(v), veh/h         | 462   | 565   | 0   | 152   | 373   | 18  | 8   | 0   | 154   | 85  | 142   | 28  |
| Grp Sat Flow(s),veh/h/ln     | 1723  | 1723  | 0   | 1757  | 1727  | 1262  | 1757  | 0   | 1719  | 1403  | 1845  | 1529  |
| Q Serve(g_s), s              | 24.1  | 25.4  | 0.0   | 7.8   | 19.5  | 0.7   | 0.4   | 0.0   | 8.0   | 5.3   | 6.0   | 0.6   |
| Cycle Q Clear(g_c), s        | 24.1  | 25.4  | 0.0   | 7.8   | 19.5  | 0.7   | 0.4   | 0.0   | 8.0   | 5.3   | 6.0   | 0.6   |
| Prop In Lane                 | 1.00  |   | 0.00  | 1.00  |   | 1.00  | 1.00  |   | 0.30  | 1.00  |   | 1.00  |
| Lane Grp Cap(c), veh/h       | 508   | 760   | 0   | 203   | 415   | 304   | 39  | 0   | 222   | 161   | 408   | 338   |
| V/C Ratio(X)                 | 0.91  | 0.74  | 0.00  | 0.75  | 0.90  | 0.06  | 0.21  | 0.00  | 0.69  | 0.53  | 0.35  | 0.08  |
| Avail Cap(c_a), veh/h        | 555   | 1202  | 0   | 377   | 927   | 677   | 283   | 0   | 369   | 226   | 408   | 338   |
| HCM Platoon Ratio            | 1.00  | 1.00  | 1.00  | 1.00  | 1.00  | 1.00  | 1.00  | 1.00  | 1.00  | 1.00  | 1.00  | 1.00  |
| Upstream Filter(I)           | 1.00  | 1.00  | 0.00  | 1.00  | 1.00  | 1.00  | 1.00  | 0.00  | 1.00  | 1.00  | 1.00  | 1.00  |
| Uniform Delay (d), s/veh     | 31.6  | 21.6  | 0.0   | 39.9  | 34.3  | 13.7  | 44.8  | 0.0   | 38.8  | 38.9  | 30.6  | 6.5   |
| Incr Delay (d2), s/veh       | 17.8  | 0.5   | 0.0   | 4.1   | 2.9   | 0.0   | 1.9   | 0.0   | 4.8   | 2.0   | 0.6   | 0.1   |
| Initial Q Delay(d3),s/veh    | 0.0   | 0.0   | 0.0   | 0.0   | 0.0   | 0.0   | 0.0   | 0.0   | 0.0   | 0.0   | 0.0   | 0.0   |
| %ile BackOfQ(50%),veh/ln     | 13.9  | 12.2  | 0.0   | 4.0   | 9.7   | 0.3   | 0.2   | 0.0   | 4.1   | 2.1   | 3.1   | 0.6   |
| LnGrp Delay(d),s/veh         | 49.4  | 22.2  | 0.0   | 43.9  | 37.1  | 13.7  | 46.7  | 0.0   | 43.6  | 40.9  | 31.2  | 6.6   |
| LnGrp LOS                    | D   | C   |   | D   | D   | B   | D   |   | D   | D   | C   | A   |
| Approach Vol, veh/h          |   | 1027  |   |   | 543   |   |   | 162   |   |   | 255   |   |
| Approach Delay, s/veh        |   | 34.4  |   |   | 38.3  |   |   | 43.8  |   |   | 31.7  |   |
| Approach LOS                 |   | C   |   |   | D   |   |   | D   |   |   | C   |   |
| Timer                        | 1   | 2   | 3   | 4   | 5   | 6   | 7   | 8   |   |   |   |   |
| Assigned Phs                 | 1   | 2   | 3   | 4   | 5   | 6   | 7   | 8   |   |   |   |   |
| Phs Duration (G+Y+Rc), s     | 14.8  | 47.1  | 6.1   | 25.2  | 33.5  | 28.4  | 14.7  | 16.6  |   |   |   |   |
| Change Period (Y+Rc), s      | 4.0   | 6.0   | 4.0   | 4.6   | 6.0   | * 6   | 4.0   | 4.6   |   |   |   |   |
| Max Green Setting (Gmax), s  | 20.0  | 65.0  | 15.0  | 20.0  | 30.0  | * 50  | 15.0  | 20.0  |   |   |   |   |
| Max Q Clear Time (g_c+I1), s | 9.8   | 27.4  | 2.4   | 8.0   | 26.1  | 21.5  | 7.3   | 10.0  |   |   |   |   |
| Green Ext Time (p_c), s      | 0.2   | 3.3   | 0.0   | 1.6   | 1.4   | 0.9   | 0.1   | 0.7   |   |   |   |   |
| <b>Intersection Summary</b>  |   |   |   |   |   |   |   |   |   |   |   |   |
| HCM 2010 Ctrl Delay          |   |   | 35.9  |   |   |   |   |   |   |   |   |   |
| HCM 2010 LOS                 |   |   | D   |   |   |   |   |   |   |   |   |   |
| <b>Notes</b>                 |   |   |   |   |   |   |   |   |   |   |   |   |

HCM 2010 Signalized Intersection Summary  
 13: Airport Way & Dr Martin Luther King Jr Boulevard





















Stockton General Plan  
 Existing PM

|                              |  |  |  |  |  |  |  |  |  |  |  |  |
|------------------------------|---|---|---|---|---|---|--|---|---|---|---|---|
| Movement                     | EBL   | EBT   | EBR   | WBL   | WBT   | WBR   | NBL  | NBT   | NBR   | SBL   | SBT   | SBR   |
| Lane Configurations          |  |  |  |  |  |  |  |  |  |  |  |  |
| Traffic Volume (veh/h)       | 137   | 643   | 409   | 284   | 564   | 67  | 462  | 580   | 303   | 87  | 343   | 138   |
| Future Volume (veh/h)        | 137   | 643   | 409   | 284   | 564   | 67  | 462  | 580   | 303   | 87  | 343   | 138   |
| Number                       | 5   | 2   | 12  | 1   | 6   | 16  | 7  | 4   | 14  | 3   | 8   | 18  |
| Initial Q (Qb), veh          | 0   | 0   | 0   | 0   | 0   | 0   | 0  | 0   | 0   | 0   | 0   | 0   |
| Ped-Bike Adj(A_pbT)          | 1.00  |   | 1.00  | 1.00  |   | 1.00  | 1.00   |   | 1.00  | 1.00  |   | 0.98  |
| Parking Bus, Adj             | 1.00  | 1.00  | 1.00  | 1.00  | 1.00  | 1.00  | 1.00   | 1.00  | 1.00  | 1.00  | 1.00  | 1.00  |
| Adj Sat Flow, veh/h/ln       | 1845  | 1759  | 1845  | 1776  | 1827  | 1845  | 1845   | 1826  | 1900  | 1845  | 1845  | 1845  |
| Adj Flow Rate, veh/h         | 149   | 699   | 227   | 309   | 613   | 27  | 502  | 630   | 0   | 95  | 373   | 30  |
| Adj No. of Lanes             | 2   | 2   | 1   | 2   | 2   | 1   | 2  | 2   | 0   | 2   | 2   | 1   |
| Peak Hour Factor             | 0.92  | 0.92  | 0.92  | 0.92  | 0.92  | 0.92  | 0.92   | 0.92  | 0.92  | 0.92  | 0.92  | 0.92  |
| Percent Heavy Veh, %         | 3   | 8   | 3   | 7   | 4   | 3   | 3  | 3   | 3   | 3   | 3   | 3   |
| Cap, veh/h                   | 218   | 1072  | 501   | 381   | 1295  | 582   | 585  | 1099  | 0   | 154   | 667   | 292   |
| Arrive On Green              | 0.06  | 0.32  | 0.32  | 0.12  | 0.37  | 0.37  | 0.17   | 0.32  | 0.00  | 0.05  | 0.19  | 0.19  |
| Sat Flow, veh/h              | 3408  | 3343  | 1564  | 3281  | 3471  | 1562  | 3408   | 3562  | 0   | 3408  | 3505  | 1534  |
| Grp Volume(v), veh/h         | 149   | 699   | 227   | 309   | 613   | 27  | 502  | 630   | 0   | 95  | 373   | 30  |
| Grp Sat Flow(s),veh/h/ln     | 1704  | 1671  | 1564  | 1640  | 1736  | 1562  | 1704   | 1735  | 0   | 1704  | 1752  | 1534  |
| Q Serve(g_s), s              | 4.2   | 17.8  | 11.5  | 9.1   | 13.4  | 1.1   | 14.2   | 15.1  | 0.0   | 2.7   | 9.6   | 1.6   |
| Cycle Q Clear(g_c), s        | 4.2   | 17.8  | 11.5  | 9.1   | 13.4  | 1.1   | 14.2   | 15.1  | 0.0   | 2.7   | 9.6   | 1.6   |
| Prop In Lane                 | 1.00  |   | 1.00  | 1.00  |   | 1.00  | 1.00   |   | 0.00  | 1.00  |   | 1.00  |
| Lane Grp Cap(c), veh/h       | 218   | 1072  | 501   | 381   | 1295  | 582   | 585  | 1099  | 0   | 154   | 667   | 292   |
| V/C Ratio(X)                 | 0.68  | 0.65  | 0.45  | 0.81  | 0.47  | 0.05  | 0.86   | 0.57  | 0.00  | 0.62  | 0.56  | 0.10  |
| Avail Cap(c_a), veh/h        | 687   | 1347  | 630   | 661   | 1295  | 582   | 1030   | 1099  | 0   | 687   | 883   | 386   |
| HCM Platoon Ratio            | 1.00  | 1.00  | 1.00  | 1.00  | 1.00  | 1.00  | 1.00   | 1.00  | 1.00  | 1.00  | 1.00  | 1.00  |
| Upstream Filter(I)           | 1.00  | 1.00  | 1.00  | 1.00  | 1.00  | 1.00  | 1.00   | 1.00  | 0.00  | 1.00  | 1.00  | 1.00  |
| Uniform Delay (d), s/veh     | 45.5  | 29.0  | 26.8  | 42.8  | 23.7  | 19.9  | 40.0   | 28.3  | 0.0   | 46.6  | 36.4  | 33.2  |
| Incr Delay (d2), s/veh       | 1.4   | 2.5   | 2.3   | 1.6   | 1.0   | 0.1   | 1.5  | 1.8   | 0.0   | 1.5   | 2.7   | 0.6   |
| Initial Q Delay(d3),s/veh    | 0.0   | 0.0   | 0.0   | 0.0   | 0.0   | 0.0   | 0.0  | 0.0   | 0.0   | 0.0   | 0.0   | 0.0   |
| %ile BackOfQ(50%),veh/ln     | 2.1   | 8.6   | 5.3   | 4.2   | 6.6   | 0.5   | 6.8  | 7.4   | 0.0   | 1.3   | 4.9   | 0.7   |
| LnGrp Delay(d),s/veh         | 46.9  | 31.4  | 29.1  | 44.4  | 24.7  | 20.0  | 41.4   | 30.1  | 0.0   | 48.1  | 39.1  | 33.8  |
| LnGrp LOS                    | D   | C   | C   | D   | C   | B   | D  | C   |   | D   | D   | C   |
| Approach Vol, veh/h          |   | 1075  |   |   | 949   |   |  | 1132  |   |   | 498   |   |
| Approach Delay, s/veh        |   | 33.1  |   |   | 31.0  |   |  | 35.1  |   |   | 40.5  |   |
| Approach LOS                 |   | C   |   |   | C   |   |  | D   |   |   | D   |   |
| Timer                        | 1   | 2   | 3   | 4   | 5   | 6   | 7  | 8   |   |   |   |   |
| Assigned Phs                 | 1   | 2   | 3   | 4   | 5   | 6   | 7  | 8   |   |   |   |   |
| Phs Duration (G+Y+Rc), s     | 16.5  | 36.8  | 9.5   | 36.4  | 11.3  | 42.0  | 22.0   | 23.9  |   |   |   |   |
| Change Period (Y+Rc), s      | 5.0   | 5.0   | 5.0   | 5.0   | 5.0   | 5.0   | 5.0  | 5.0   |   |   |   |   |
| Max Green Setting (Gmax), s  | 20.0  | 40.0  | 20.0  | 30.0  | 20.0  | 30.0  | 30.0   | 25.0  |   |   |   |   |
| Max Q Clear Time (g_c+I1), s | 11.1  | 19.8  | 4.7   | 17.1  | 6.2   | 15.4  | 16.2   | 11.6  |   |   |   |   |
| Green Ext Time (p_c), s      | 0.4   | 12.0  | 0.1   | 9.1   | 0.2   | 12.7  | 0.8  | 7.1   |   |   |   |   |
| <b>Intersection Summary</b>  |   |   |   |   |   |   |  |   |   |   |   |   |
| HCM 2010 Ctrl Delay          |   |   | 34.2  |   |   |   |  |   |   |   |   |   |
| HCM 2010 LOS                 |   |   | C   |   |   |   |  |   |   |   |   |   |
| <b>Notes</b>                 |   |   |   |   |   |   |  |   |   |   |   |   |

| Movement                     | EBL  | EBT  | EBR  | WBL  | WBT  | WBR  | NBL  | NBT  | NBR  | SBL  | SBT  | SBR  |
|------------------------------|------|------|------|------|------|------|------|------|------|------|------|------|
| Lane Configurations          |      |      |      |      |      |      |      |      |      |      |      |      |
| Traffic Volume (veh/h)       | 15   | 415  | 583  | 130  | 295  | 4    | 444  | 13   | 125  | 41   | 42   | 46   |
| Future Volume (veh/h)        | 15   | 415  | 583  | 130  | 295  | 4    | 444  | 13   | 125  | 41   | 42   | 46   |
| Number                       | 5    | 2    | 12   | 1    | 6    | 16   | 3    | 8    | 18   | 7    | 4    | 14   |
| Initial Q (Qb), veh          | 0    | 0    | 0    | 0    | 0    | 0    | 0    | 0    | 0    | 0    | 0    | 0    |
| Ped-Bike Adj(A_pbT)          | 1.00 |      | 1.00 | 1.00 |      | 1.00 | 1.00 |      | 1.00 | 1.00 |      | 1.00 |
| Parking Bus, Adj             | 1.00 | 1.00 | 1.00 | 1.00 | 1.00 | 1.00 | 1.00 | 1.00 | 1.00 | 1.00 | 1.00 | 1.00 |
| Adj Sat Flow, veh/h/ln       | 1496 | 1827 | 1845 | 1827 | 1805 | 1900 | 1810 | 1788 | 1900 | 1776 | 1726 | 1900 |
| Adj Flow Rate, veh/h         | 17   | 461  | 0    | 144  | 328  | 0    | 503  | 0    | 0    | 46   | 47   | 0    |
| Adj No. of Lanes             | 1    | 2    | 1    | 1    | 2    | 0    | 2    | 1    | 0    | 1    | 1    | 0    |
| Peak Hour Factor             | 0.90 | 0.90 | 0.90 | 0.90 | 0.90 | 0.90 | 0.90 | 0.90 | 0.90 | 0.90 | 0.90 | 0.90 |
| Percent Heavy Veh, %         | 27   | 4    | 3    | 4    | 5    | 5    | 5    | 54   | 54   | 7    | 17   | 17   |
| Cap, veh/h                   | 23   | 1132 | 511  | 183  | 1424 | 0    | 640  | 332  | 0    | 84   | 86   | 0    |
| Arrive On Green              | 0.02 | 0.33 | 0.00 | 0.11 | 0.42 | 0.00 | 0.19 | 0.00 | 0.00 | 0.05 | 0.05 | 0.00 |
| Sat Flow, veh/h              | 1425 | 3471 | 1568 | 1740 | 3520 | 0    | 3447 | 1788 | 0    | 1691 | 1726 | 0    |
| Grp Volume(v), veh/h         | 17   | 461  | 0    | 144  | 328  | 0    | 503  | 0    | 0    | 46   | 47   | 0    |
| Grp Sat Flow(s),veh/h/ln     | 1425 | 1736 | 1568 | 1740 | 1715 | 0    | 1723 | 1788 | 0    | 1691 | 1726 | 0    |
| Q Serve(g_s), s              | 0.8  | 6.8  | 0.0  | 5.3  | 4.1  | 0.0  | 9.2  | 0.0  | 0.0  | 1.8  | 1.8  | 0.0  |
| Cycle Q Clear(g_c), s        | 0.8  | 6.8  | 0.0  | 5.3  | 4.1  | 0.0  | 9.2  | 0.0  | 0.0  | 1.8  | 1.8  | 0.0  |
| Prop In Lane                 | 1.00 |      | 1.00 | 1.00 |      | 0.00 | 1.00 |      | 0.00 | 1.00 |      | 0.00 |
| Lane Grp Cap(c), veh/h       | 23   | 1132 | 511  | 183  | 1424 | 0    | 640  | 332  | 0    | 84   | 86   | 0    |
| V/C Ratio(X)                 | 0.74 | 0.41 | 0.00 | 0.79 | 0.23 | 0.00 | 0.79 | 0.00 | 0.00 | 0.55 | 0.55 | 0.00 |
| Avail Cap(c_a), veh/h        | 518  | 2105 | 951  | 659  | 2080 | 0    | 1567 | 813  | 0    | 641  | 654  | 0    |
| HCM Platoon Ratio            | 1.00 | 1.00 | 1.00 | 1.00 | 1.00 | 1.00 | 1.00 | 1.00 | 1.00 | 1.00 | 1.00 | 1.00 |
| Upstream Filter(I)           | 1.00 | 1.00 | 0.00 | 1.00 | 1.00 | 0.00 | 1.00 | 0.00 | 0.00 | 1.00 | 1.00 | 0.00 |
| Uniform Delay (d), s/veh     | 32.3 | 17.3 | 0.0  | 28.8 | 12.5 | 0.0  | 25.6 | 0.0  | 0.0  | 30.6 | 30.6 | 0.0  |
| Incr Delay (d2), s/veh       | 15.4 | 0.9  | 0.0  | 2.8  | 0.3  | 0.0  | 0.8  | 0.0  | 0.0  | 2.1  | 2.0  | 0.0  |
| Initial Q Delay(d3),s/veh    | 0.0  | 0.0  | 0.0  | 0.0  | 0.0  | 0.0  | 0.0  | 0.0  | 0.0  | 0.0  | 0.0  | 0.0  |
| %ile BackOfQ(50%),veh/ln     | 0.4  | 3.4  | 0.0  | 2.7  | 2.0  | 0.0  | 4.4  | 0.0  | 0.0  | 0.9  | 0.9  | 0.0  |
| LnGrp Delay(d),s/veh         | 47.7 | 18.1 | 0.0  | 31.6 | 12.8 | 0.0  | 26.4 | 0.0  | 0.0  | 32.7 | 32.7 | 0.0  |
| LnGrp LOS                    | D    | B    |      | C    | B    |      | C    |      |      | C    | C    |      |
| Approach Vol, veh/h          |      | 478  |      |      | 472  |      |      | 503  |      |      | 93   |      |
| Approach Delay, s/veh        |      | 19.2 |      |      | 18.5 |      |      | 26.4 |      |      | 32.7 |      |
| Approach LOS                 |      | B    |      |      | B    |      |      | C    |      |      | C    |      |
| Timer                        | 1    | 2    | 3    | 4    | 5    | 6    | 7    | 8    |      |      |      |      |
| Assigned Phs                 | 1    | 2    |      | 4    | 5    | 6    |      | 8    |      |      |      |      |
| Phs Duration (G+Y+Rc), s     | 11.9 | 27.5 |      | 8.3  | 6.1  | 33.4 |      | 18.2 |      |      |      |      |
| Change Period (Y+Rc), s      | 5.0  | 6.0  |      | 5.0  | 5.0  | 6.0  |      | 6.0  |      |      |      |      |
| Max Green Setting (Gmax), s  | 25.0 | 40.0 |      | 25.0 | 24.0 | 40.0 |      | 30.0 |      |      |      |      |
| Max Q Clear Time (g_c+I1), s | 7.3  | 8.8  |      | 3.8  | 2.8  | 6.1  |      | 11.2 |      |      |      |      |
| Green Ext Time (p_c), s      | 0.1  | 12.7 |      | 0.2  | 0.0  | 13.2 |      | 0.9  |      |      |      |      |
| <b>Intersection Summary</b>  |      |      |      |      |      |      |      |      |      |      |      |      |
| HCM 2010 Ctrl Delay          |      |      | 22.2 |      |      |      |      |      |      |      |      |      |
| HCM 2010 LOS                 |      |      | C    |      |      |      |      |      |      |      |      |      |
| <b>Notes</b>                 |      |      |      |      |      |      |      |      |      |      |      |      |























HCM 2010 Signalized Intersection Summary  
 15: Mariposa Road & Stagecoach Road

Stockton General Plan  
 Existing PM

|                              |  |  |  |  |  |  |  |  |  |  |  |  |
|------------------------------|---|---|---|---|---|---|--|---|---|---|---|---|
| Movement                     | EBL   | EBT   | EBR   | WBL   | WBT   | WBR   | NBL  | NBT   | NBR   | SBL   | SBT   | SBR   |
| Lane Configurations          |  |  |   |  |  |  |  |  |   |   |  |  |
| Traffic Volume (veh/h)       | 7   | 0   | 2   | 60  | 0   | 126   | 1  | 542   | 57  | 61  | 524   | 0   |
| Future Volume (veh/h)        | 7   | 0   | 2   | 60  | 0   | 126   | 1  | 542   | 57  | 61  | 524   | 0   |
| Number                       | 5   | 2   | 12  | 1   | 6   | 16  | 3  | 8   | 18  | 7   | 4   | 14  |
| Initial Q (Qb), veh          | 0   | 0   | 0   | 0   | 0   | 0   | 0  | 0   | 0   | 0   | 0   | 0   |
| Ped-Bike Adj(A_pbT)          | 1.00  |   | 1.00  | 1.00  |   | 1.00  | 1.00   |   | 1.00  | 1.00  |   | 1.00  |
| Parking Bus, Adj             | 1.00  | 1.00  | 1.00  | 1.00  | 1.00  | 1.00  | 1.00   | 1.00  | 1.00  | 1.00  | 1.00  | 1.00  |
| Adj Sat Flow, veh/h/ln       | 1845  | 1845  | 1900  | 1759  | 1845  | 1610  | 1900   | 1658  | 1900  | 1900  | 1607  | 1845  |
| Adj Flow Rate, veh/h         | 7   | 0   | 0   | 61  | 0   | 24  | 1  | 553   | 56  | 62  | 535   | 0   |
| Adj No. of Lanes             | 1   | 2   | 0   | 1   | 2   | 1   | 0  | 1   | 0   | 0   | 1   | 1   |
| Peak Hour Factor             | 0.98  | 0.98  | 0.98  | 0.98  | 0.98  | 0.98  | 0.98   | 0.98  | 0.98  | 0.98  | 0.98  | 0.98  |
| Percent Heavy Veh, %         | 3   | 3   | 3   | 8   | 3   | 18  | 15   | 15  | 15  | 15  | 15  | 3   |
| Cap, veh/h                   | 33  | 7   | 0   | 192   | 298   | 116   | 72   | 882   | 89  | 134   | 836   | 934   |
| Arrive On Green              | 0.02  | 0.00  | 0.00  | 0.11  | 0.00  | 0.09  | 0.60   | 0.60  | 0.60  | 0.60  | 0.60  | 0.00  |
| Sat Flow, veh/h              | 1757  | 3597  | 0   | 1675  | 3505  | 1369  | 0  | 1481  | 150   | 91  | 1402  | 1568  |
| Grp Volume(v), veh/h         | 7   | 0   | 0   | 61  | 0   | 24  | 610  | 0   | 0   | 597   | 0   | 0   |
| Grp Sat Flow(s),veh/h/ln     | 1757  | 1752  | 0   | 1675  | 1752  | 1369  | 1631   | 0   | 0   | 1493  | 0   | 1568  |
| Q Serve(g_s), s              | 0.2   | 0.0   | 0.0   | 1.7   | 0.0   | 0.8   | 0.0  | 0.0   | 0.0   | 0.0   | 0.0   | 0.0   |
| Cycle Q Clear(g_c), s        | 0.2   | 0.0   | 0.0   | 1.7   | 0.0   | 0.8   | 12.0   | 0.0   | 0.0   | 11.9  | 0.0   | 0.0   |
| Prop In Lane                 | 1.00  |   | 0.00  | 1.00  |   | 1.00  | 0.00   |   | 0.09  | 0.10  |   | 1.00  |
| Lane Grp Cap(c), veh/h       | 33  | 7   | 0   | 192   | 298   | 116   | 1044   | 0   | 0   | 969   | 0   | 934   |
| V/C Ratio(X)                 | 0.22  | 0.00  | 0.00  | 0.32  | 0.00  | 0.21  | 0.58   | 0.00  | 0.00  | 0.62  | 0.00  | 0.00  |
| Avail Cap(c_a), veh/h        | 1056  | 3512  | 0   | 1007  | 3512  | 1371  | 1706   | 0   | 0   | 1544  | 0   | 1571  |
| HCM Platoon Ratio            | 1.00  | 1.00  | 1.00  | 1.00  | 1.00  | 1.00  | 1.00   | 1.00  | 1.00  | 1.00  | 1.00  | 1.00  |
| Upstream Filter(I)           | 1.00  | 0.00  | 0.00  | 1.00  | 0.00  | 1.00  | 1.00   | 0.00  | 0.00  | 1.00  | 0.00  | 0.00  |
| Uniform Delay (d), s/veh     | 24.1  | 0.0   | 0.0   | 20.3  | 0.0   | 21.3  | 6.5  | 0.0   | 0.0   | 6.5   | 0.0   | 0.0   |
| Incr Delay (d2), s/veh       | 4.6   | 0.0   | 0.0   | 1.3   | 0.0   | 1.8   | 0.7  | 0.0   | 0.0   | 0.9   | 0.0   | 0.0   |
| Initial Q Delay(d3),s/veh    | 0.0   | 0.0   | 0.0   | 0.0   | 0.0   | 0.0   | 0.0  | 0.0   | 0.0   | 0.0   | 0.0   | 0.0   |
| %ile BackOfQ(50%),veh/ln     | 0.1   | 0.0   | 0.0   | 0.8   | 0.0   | 0.4   | 5.5  | 0.0   | 0.0   | 5.4   | 0.0   | 0.0   |
| LnGrp Delay(d),s/veh         | 28.7  | 0.0   | 0.0   | 21.7  | 0.0   | 23.1  | 7.3  | 0.0   | 0.0   | 7.4   | 0.0   | 0.0   |
| LnGrp LOS                    | C   |   |   | C   |   | C   | A  |   |   | A   |   |   |
| Approach Vol, veh/h          |   | 7   |   |   | 85  |   |  | 610   |   |   | 597   |   |
| Approach Delay, s/veh        |   | 28.7  |   |   | 22.1  |   |  | 7.3   |   |   | 7.4   |   |
| Approach LOS                 |   | C   |   |   | C   |   |  | A   |   |   | A   |   |
| Timer                        | 1   | 2   | 3   | 4   | 5   | 6   | 7  | 8   |   |   |   |   |
| Assigned Phs                 | 1   | 2   |   | 4   | 5   | 6   |  | 8   |   |   |   |   |
| Phs Duration (G+Y+Rc), s     | 10.7  | 4.5   |   | 34.7  | 5.9   | 9.2   |  | 34.7  |   |   |   |   |
| Change Period (Y+Rc), s      | 5.0   | 5.0   |   | 5.0   | 5.0   | 5.0   |  | 5.0   |   |   |   |   |
| Max Green Setting (Gmax), s  | 30.0  | 50.0  |   | 50.0  | 30.0  | 50.0  |  | 50.0  |   |   |   |   |
| Max Q Clear Time (g_c+I1), s | 3.7   | 0.0   |   | 13.9  | 2.2   | 2.8   |  | 14.0  |   |   |   |   |
| Green Ext Time (p_c), s      | 0.2   | 0.0   |   | 15.7  | 0.0   | 0.1   |  | 15.7  |   |   |   |   |
| <b>Intersection Summary</b>  |   |   |   |   |   |   |  |   |   |   |   |   |
| HCM 2010 Ctrl Delay          |   |   |   | 8.4   |   |   |  |   |   |   |   |   |
| HCM 2010 LOS                 |   |   |   | A   |   |   |  |   |   |   |   |   |





















HCM 2010 Signalized Intersection Summary  
 16: McDougald Boulevard & Carolyn Weston Boulevard

Stockton General Plan  
 Existing PM

|                              |  |  |  |  |  |  |  |  |  |  |  |  |
|------------------------------|---|---|---|---|---|---|--|---|---|---|---|---|
| Movement                     | EBL   | EBT   | EBR   | WBL   | WBT   | WBR   | NBL  | NBT   | NBR   | SBL   | SBT   | SBR   |
| Lane Configurations          |  |  |   |  |  |   |  |  |  |  |  |  |
| Traffic Volume (veh/h)       | 1   | 529   | 6   | 193   | 808   | 19  | 3  | 1   | 119   | 22  | 2   | 1   |
| Future Volume (veh/h)        | 1   | 529   | 6   | 193   | 808   | 19  | 3  | 1   | 119   | 22  | 2   | 1   |
| Number                       | 5   | 2   | 12  | 1   | 6   | 16  | 3  | 8   | 18  | 7   | 4   | 14  |
| Initial Q (Qb), veh          | 0   | 0   | 0   | 0   | 0   | 0   | 0  | 0   | 0   | 0   | 0   | 0   |
| Ped-Bike Adj(A_pbT)          | 1.00  |   | 1.00  | 1.00  |   | 1.00  | 1.00   |   | 0.99  | 1.00  |   | 1.00  |
| Parking Bus, Adj             | 1.00  | 1.00  | 1.00  | 1.00  | 1.00  | 1.00  | 1.00   | 1.00  | 1.00  | 1.00  | 1.00  | 1.00  |
| Adj Sat Flow, veh/h/ln       | 1845  | 1845  | 1900  | 1845  | 1845  | 1900  | 1845   | 1845  | 1845  | 1845  | 1845  | 1900  |
| Adj Flow Rate, veh/h         | 1   | 557   | 5   | 203   | 851   | 20  | 3  | 1   | 13  | 23  | 2   | 0   |
| Adj No. of Lanes             | 1   | 2   | 0   | 1   | 2   | 0   | 1  | 1   | 1   | 1   | 1   | 0   |
| Peak Hour Factor             | 0.95  | 0.95  | 0.95  | 0.95  | 0.95  | 0.95  | 0.95   | 0.95  | 0.95  | 0.95  | 0.95  | 0.95  |
| Percent Heavy Veh, %         | 3   | 3   | 3   | 3   | 3   | 3   | 3  | 3   | 3   | 3   | 3   | 3   |
| Cap, veh/h                   | 3   | 1859  | 17  | 250   | 2322  | 55  | 6  | 31  | 26  | 37  | 63  | 0   |
| Arrive On Green              | 0.00  | 0.52  | 0.52  | 0.14  | 0.66  | 0.66  | 0.00   | 0.02  | 0.02  | 0.02  | 0.03  | 0.00  |
| Sat Flow, veh/h              | 1757  | 3559  | 32  | 1757  | 3500  | 82  | 1757   | 1845  | 1560  | 1757  | 1845  | 0   |
| Grp Volume(v), veh/h         | 1   | 274   | 288   | 203   | 426   | 445   | 3  | 1   | 13  | 23  | 2   | 0   |
| Grp Sat Flow(s),veh/h/ln     | 1757  | 1752  | 1839  | 1757  | 1752  | 1830  | 1757   | 1845  | 1560  | 1757  | 1845  | 0   |
| Q Serve(g_s), s              | 0.0   | 5.9   | 5.9   | 7.5   | 7.3   | 7.3   | 0.1  | 0.0   | 0.6   | 0.9   | 0.1   | 0.0   |
| Cycle Q Clear(g_c), s        | 0.0   | 5.9   | 5.9   | 7.5   | 7.3   | 7.3   | 0.1  | 0.0   | 0.6   | 0.9   | 0.1   | 0.0   |
| Prop In Lane                 | 1.00  |   | 0.02  | 1.00  |   | 0.04  | 1.00   |   | 1.00  | 1.00  |   | 0.00  |
| Lane Grp Cap(c), veh/h       | 3   | 915   | 960   | 250   | 1162  | 1214  | 6  | 31  | 26  | 37  | 63  | 0   |
| V/C Ratio(X)                 | 0.38  | 0.30  | 0.30  | 0.81  | 0.37  | 0.37  | 0.53   | 0.03  | 0.50  | 0.63  | 0.03  | 0.00  |
| Avail Cap(c_a), veh/h        | 786   | 1254  | 1316  | 786   | 1254  | 1310  | 786  | 825   | 698   | 786   | 825   | 0   |
| HCM Platoon Ratio            | 1.00  | 1.00  | 1.00  | 1.00  | 1.00  | 1.00  | 1.00   | 1.00  | 1.00  | 1.00  | 1.00  | 1.00  |
| Upstream Filter(I)           | 1.00  | 1.00  | 1.00  | 1.00  | 1.00  | 1.00  | 1.00   | 1.00  | 1.00  | 1.00  | 1.00  | 0.00  |
| Uniform Delay (d), s/veh     | 33.5  | 9.1   | 9.1   | 27.9  | 5.0   | 5.0   | 33.4   | 32.4  | 32.7  | 32.6  | 31.3  | 0.0   |
| Incr Delay (d2), s/veh       | 30.7  | 0.7   | 0.6   | 2.4   | 0.7   | 0.7   | 25.2   | 0.2   | 5.4   | 6.5   | 0.1   | 0.0   |
| Initial Q Delay(d3),s/veh    | 0.0   | 0.0   | 0.0   | 0.0   | 0.0   | 0.0   | 0.0  | 0.0   | 0.0   | 0.0   | 0.0   | 0.0   |
| %ile BackOfQ(50%),veh/ln     | 0.0   | 3.0   | 3.1   | 3.8   | 3.7   | 3.8   | 0.1  | 0.0   | 0.3   | 0.5   | 0.0   | 0.0   |
| LnGrp Delay(d),s/veh         | 64.1  | 9.7   | 9.7   | 30.3  | 5.7   | 5.7   | 58.6   | 32.6  | 38.1  | 39.1  | 31.4  | 0.0   |
| LnGrp LOS                    | E   | A   | A   | C   | A   | A   | E  | C   | D   | D   | C   |   |
| Approach Vol, veh/h          |   | 563   |   |   | 1074  |   |  | 17  |   |   | 25  |   |
| Approach Delay, s/veh        |   | 9.8   |   |   | 10.4  |   |  | 41.4  |   |   | 38.4  |   |
| Approach LOS                 |   | A   |   |   | B   |   |  | D   |   |   | D   |   |
| Timer                        | 1   | 2   | 3   | 4   | 5   | 6   | 7  | 8   |   |   |   |   |
| Assigned Phs                 | 1   | 2   | 3   | 4   | 5   | 6   | 7  | 8   |   |   |   |   |
| Phs Duration (G+Y+Rc), s     | 14.5  | 40.0  | 5.2   | 7.3   | 5.1   | 49.5  | 6.4  | 6.1   |   |   |   |   |
| Change Period (Y+Rc), s      | 5.0   | 5.0   | 5.0   | 5.0   | 5.0   | 5.0   | 5.0  | 5.0   |   |   |   |   |
| Max Green Setting (Gmax), s  | 30.0  | 48.0  | 30.0  | 30.0  | 30.0  | 48.0  | 30.0   | 30.0  |   |   |   |   |
| Max Q Clear Time (g_c+I1), s | 9.5   | 7.9   | 2.1   | 2.1   | 2.0   | 9.3   | 2.9  | 2.6   |   |   |   |   |
| Green Ext Time (p_c), s      | 0.2   | 27.1  | 0.0   | 0.0   | 0.0   | 26.5  | 0.0  | 0.0   |   |   |   |   |
| <b>Intersection Summary</b>  |   |   |   |   |   |   |  |   |   |   |   |   |
| HCM 2010 Ctrl Delay          |   |   | 10.9  |   |   |   |  |   |   |   |   |   |
| HCM 2010 LOS                 |   |   | B   |   |   |   |  |   |   |   |   |   |





















HCM 2010 Signalized Intersection Summary  
17: Airport Way & Ralph Avenue

Stockton General Plan  
Existing PM

|                              |  |  |  |  |  |  |  |  |  |  |  |  |
|------------------------------|---|---|---|---|---|---|--|---|---|---|---|---|
| Movement                     | EBL   | EBT   | EBR   | WBL   | WBT   | WBR   | NBL  | NBT   | NBR   | SBL   | SBT   | SBR   |
| Lane Configurations          |   |  |   |   |  |  |  |  |  |  |  |  |
| Traffic Volume (veh/h)       | 97  | 23  | 24  | 34  | 3   | 83  | 15   | 647   | 30  | 209   | 379   | 17  |
| Future Volume (veh/h)        | 97  | 23  | 24  | 34  | 3   | 83  | 15   | 647   | 30  | 209   | 379   | 17  |
| Number                       | 3   | 8   | 18  | 7   | 4   | 14  | 5  | 2   | 12  | 1   | 6   | 16  |
| Initial Q (Qb), veh          | 0   | 0   | 0   | 0   | 0   | 0   | 0  | 0   | 0   | 0   | 0   | 0   |
| Ped-Bike Adj(A_pbT)          | 1.00  |   | 1.00  | 1.00  |   | 1.00  | 1.00   |   | 0.98  | 1.00  |   | 0.98  |
| Parking Bus, Adj             | 1.00  | 1.00  | 1.00  | 1.00  | 1.00  | 1.00  | 1.00   | 1.00  | 1.00  | 1.00  | 1.00  | 1.00  |
| Adj Sat Flow, veh/h/ln       | 1900  | 1792  | 1900  | 1900  | 1807  | 1845  | 1583   | 1811  | 1900  | 1845  | 1810  | 1610  |
| Adj Flow Rate, veh/h         | 111   | 26  | 22  | 39  | 3   | 19  | 17   | 744   | 31  | 240   | 436   | 12  |
| Adj No. of Lanes             | 0   | 1   | 0   | 0   | 1   | 1   | 1  | 2   | 0   | 1   | 2   | 1   |
| Peak Hour Factor             | 0.87  | 0.87  | 0.87  | 0.87  | 0.87  | 0.87  | 0.87   | 0.87  | 0.87  | 0.87  | 0.87  | 0.87  |
| Percent Heavy Veh, %         | 3   | 3   | 3   | 33  | 33  | 3   | 20   | 5   | 5   | 3   | 5   | 18  |
| Cap, veh/h                   | 216   | 48  | 29  | 293   | 19  | 252   | 24   | 1550  | 65  | 284   | 2086  | 813   |
| Arrive On Green              | 0.16  | 0.16  | 0.16  | 0.16  | 0.16  | 0.16  | 0.02   | 0.46  | 0.46  | 0.16  | 0.61  | 0.61  |
| Sat Flow, veh/h              | 826   | 296   | 180   | 1238  | 119   | 1562  | 1508   | 3363  | 140   | 1757  | 3438  | 1340  |
| Grp Volume(v), veh/h         | 159   | 0   | 0   | 42  | 0   | 19  | 17   | 380   | 395   | 240   | 436   | 12  |
| Grp Sat Flow(s),veh/h/ln     | 1301  | 0   | 0   | 1357  | 0   | 1562  | 1508   | 1720  | 1783  | 1757  | 1719  | 1340  |
| Q Serve(g_s), s              | 7.0   | 0.0   | 0.0   | 0.0   | 0.0   | 0.8   | 0.8  | 11.3  | 11.3  | 9.8   | 4.2   | 0.3   |
| Cycle Q Clear(g_c), s        | 8.9   | 0.0   | 0.0   | 1.9   | 0.0   | 0.8   | 0.8  | 11.3  | 11.3  | 9.8   | 4.2   | 0.3   |
| Prop In Lane                 | 0.70  |   | 0.14  | 0.93  |   | 1.00  | 1.00   |   | 0.08  | 1.00  |   | 1.00  |
| Lane Grp Cap(c), veh/h       | 292   | 0   | 0   | 312   | 0   | 252   | 24   | 793   | 822   | 284   | 2086  | 813   |
| V/C Ratio(X)                 | 0.54  | 0.00  | 0.00  | 0.13  | 0.00  | 0.08  | 0.71   | 0.48  | 0.48  | 0.84  | 0.21  | 0.01  |
| Avail Cap(c_a), veh/h        | 522   | 0   | 0   | 530   | 0   | 506   | 489  | 1115  | 1156  | 569   | 2229  | 869   |
| HCM Platoon Ratio            | 1.00  | 1.00  | 1.00  | 1.00  | 1.00  | 1.00  | 1.00   | 1.00  | 1.00  | 1.00  | 1.00  | 1.00  |
| Upstream Filter(I)           | 1.00  | 0.00  | 0.00  | 1.00  | 0.00  | 1.00  | 1.00   | 1.00  | 1.00  | 1.00  | 1.00  | 1.00  |
| Uniform Delay (d), s/veh     | 30.1  | 0.0   | 0.0   | 26.8  | 0.0   | 26.4  | 36.3   | 13.8  | 13.8  | 30.1  | 6.6   | 5.8   |
| Incr Delay (d2), s/veh       | 0.6   | 0.0   | 0.0   | 0.1   | 0.0   | 0.0   | 13.2   | 1.6   | 1.6   | 2.7   | 0.2   | 0.0   |
| Initial Q Delay(d3),s/veh    | 0.0   | 0.0   | 0.0   | 0.0   | 0.0   | 0.0   | 0.0  | 0.0   | 0.0   | 0.0   | 0.0   | 0.0   |
| %ile BackOfQ(50%),veh/ln     | 3.1   | 0.0   | 0.0   | 0.8   | 0.0   | 0.3   | 0.4  | 5.8   | 5.9   | 4.9   | 2.1   | 0.1   |
| LnGrp Delay(d),s/veh         | 30.7  | 0.0   | 0.0   | 26.9  | 0.0   | 26.4  | 49.5   | 15.4  | 15.4  | 32.8  | 6.7   | 5.8   |
| LnGrp LOS                    | C   |   |   | C   |   | C   | D  | B   | B   | C   | A   | A   |
| Approach Vol, veh/h          |   | 159   |   |   | 61  |   |  | 792   |   |   | 688   |   |
| Approach Delay, s/veh        |   | 30.7  |   |   | 26.8  |   |  | 16.2  |   |   | 15.8  |   |
| Approach LOS                 |   | C   |   |   | C   |   |  | B   |   |   | B   |   |
| Timer                        | 1   | 2   | 3   | 4   | 5   | 6   | 7  | 8   |   |   |   |   |
| Assigned Phs                 | 1   | 2   |   | 4   | 5   | 6   |  | 8   |   |   |   |   |
| Phs Duration (G+Y+Rc), s     | 17.0  | 40.1  |   | 16.9  | 6.2   | 50.9  |  | 16.9  |   |   |   |   |
| Change Period (Y+Rc), s      | 5.0   | 6.0   |   | 5.0   | 5.0   | 6.0   |  | 5.0   |   |   |   |   |
| Max Green Setting (Gmax), s  | 24.0  | 48.0  |   | 24.0  | 24.0  | 48.0  |  | 24.0  |   |   |   |   |
| Max Q Clear Time (g_c+I1), s | 11.8  | 13.3  |   | 3.9   | 2.8   | 6.2   |  | 10.9  |   |   |   |   |
| Green Ext Time (p_c), s      | 0.3   | 20.8  |   | 0.7   | 0.0   | 23.3  |  | 0.6   |   |   |   |   |
| <b>Intersection Summary</b>  |   |   |   |   |   |   |  |   |   |   |   |   |
| HCM 2010 Ctrl Delay          |   |   |   | 17.8  |   |   |  |   |   |   |   |   |
| HCM 2010 LOS                 |   |   |   | B   |   |   |  |   |   |   |   |   |
| <b>Notes</b>                 |   |   |   |   |   |   |  |   |   |   |   |   |

HCM 2010 Signalized Intersection Summary  
 18: Airport Way & Sperry Road/Arch Airport Road





















Stockton General Plan  
 Existing PM

|                              |  |  |  |  |  |  |   |  |  |  |  |  |
|------------------------------|---|---|---|---|---|---|---|---|---|---|---|---|
| Movement                     | EBL   | EBT   | EBR   | WBL   | WBT   | WBR   | NBL   | NBT   | NBR   | SBL   | SBT   | SBR   |
| Lane Configurations          |  |  |   |  |  |   |  |  |   |  |  |   |
| Traffic Volume (veh/h)       | 187   | 524   | 21  | 100   | 591   | 112   | 51  | 293   | 196   | 150   | 287   | 282   |
| Future Volume (veh/h)        | 187   | 524   | 21  | 100   | 591   | 112   | 51  | 293   | 196   | 150   | 287   | 282   |
| Number                       | 7   | 4   | 14  | 3   | 8   | 18  | 5   | 2   | 12  | 1   | 6   | 16  |
| Initial Q (Qb), veh          | 0   | 0   | 0   | 0   | 0   | 0   | 0   | 0   | 0   | 0   | 0   | 0   |
| Ped-Bike Adj(A_pbT)          | 1.00  |   | 1.00  | 1.00  |   | 1.00  | 1.00  |   | 1.00  | 1.00  |   | 1.00  |
| Parking Bus, Adj             | 1.00  | 1.00  | 1.00  | 1.00  | 1.00  | 1.00  | 1.00  | 1.00  | 1.00  | 1.00  | 1.00  | 1.00  |
| Adj Sat Flow, veh/h/ln       | 1545  | 1597  | 1900  | 1570  | 1621  | 1900  | 1727  | 1696  | 1900  | 1638  | 1705  | 1900  |
| Adj Flow Rate, veh/h         | 208   | 582   | 21  | 111   | 657   | 114   | 57  | 326   | 141   | 167   | 319   | 201   |
| Adj No. of Lanes             | 1   | 2   | 0   | 1   | 2   | 0   | 1   | 2   | 0   | 1   | 2   | 0   |
| Peak Hour Factor             | 0.90  | 0.90  | 0.90  | 0.90  | 0.90  | 0.90  | 0.90  | 0.90  | 0.90  | 0.90  | 0.90  | 0.90  |
| Percent Heavy Veh, %         | 23  | 19  | 19  | 21  | 15  | 15  | 10  | 6   | 6   | 16  | 6   | 6   |
| Cap, veh/h                   | 234   | 1036  | 37  | 134   | 728   | 126   | 72  | 513   | 218   | 194   | 604   | 372   |
| Arrive On Green              | 0.16  | 0.35  | 0.35  | 0.09  | 0.28  | 0.28  | 0.04  | 0.23  | 0.23  | 0.12  | 0.31  | 0.31  |
| Sat Flow, veh/h              | 1471  | 2987  | 108   | 1495  | 2625  | 455   | 1645  | 2207  | 936   | 1560  | 1928  | 1187  |
| Grp Volume(v), veh/h         | 208   | 295   | 308   | 111   | 385   | 386   | 57  | 236   | 231   | 167   | 267   | 253   |
| Grp Sat Flow(s),veh/h/ln     | 1471  | 1517  | 1578  | 1495  | 1540  | 1541  | 1645  | 1611  | 1531  | 1560  | 1620  | 1495  |
| Q Serve(g_s), s              | 14.7  | 16.8  | 16.8  | 7.8   | 25.6  | 25.7  | 3.7   | 14.0  | 14.5  | 11.2  | 14.4  | 14.9  |
| Cycle Q Clear(g_c), s        | 14.7  | 16.8  | 16.8  | 7.8   | 25.6  | 25.7  | 3.7   | 14.0  | 14.5  | 11.2  | 14.4  | 14.9  |
| Prop In Lane                 | 1.00  |   | 0.07  | 1.00  |   | 0.30  | 1.00  |   | 0.61  | 1.00  |   | 0.79  |
| Lane Grp Cap(c), veh/h       | 234   | 526   | 547   | 134   | 427   | 427   | 72  | 375   | 356   | 194   | 508   | 469   |
| V/C Ratio(X)                 | 0.89  | 0.56  | 0.56  | 0.83  | 0.90  | 0.90  | 0.79  | 0.63  | 0.65  | 0.86  | 0.53  | 0.54  |
| Avail Cap(c_a), veh/h        | 387   | 526   | 547   | 394   | 506   | 507   | 386   | 485   | 460   | 440   | 508   | 469   |
| HCM Platoon Ratio            | 1.00  | 1.00  | 1.00  | 1.00  | 1.00  | 1.00  | 1.00  | 1.00  | 1.00  | 1.00  | 1.00  | 1.00  |
| Upstream Filter(I)           | 1.00  | 1.00  | 1.00  | 1.00  | 1.00  | 1.00  | 1.00  | 1.00  | 1.00  | 1.00  | 1.00  | 1.00  |
| Uniform Delay (d), s/veh     | 43.8  | 28.2  | 28.2  | 47.7  | 37.1  | 37.1  | 50.4  | 36.7  | 36.9  | 45.7  | 30.0  | 30.2  |
| Incr Delay (d2), s/veh       | 8.0   | 0.8   | 0.8   | 5.0   | 15.9  | 16.2  | 7.2   | 6.2   | 7.0   | 4.3   | 3.1   | 3.6   |
| Initial Q Delay(d3),s/veh    | 0.0   | 0.0   | 0.0   | 0.0   | 0.0   | 0.0   | 0.0   | 0.0   | 0.0   | 0.0   | 0.0   | 0.0   |
| %ile BackOfQ(50%),veh/ln     | 6.5   | 7.2   | 7.5   | 3.4   | 12.8  | 12.9  | 1.8   | 6.9   | 6.8   | 5.1   | 6.9   | 6.6   |
| LnGrp Delay(d),s/veh         | 51.8  | 29.0  | 29.0  | 52.6  | 53.0  | 53.3  | 57.6  | 43.0  | 43.9  | 49.9  | 33.1  | 33.8  |
| LnGrp LOS                    | D   | C   | C   | D   | D   | D   | E   | D   | D   | D   | C   | C   |
| Approach Vol, veh/h          |   | 811   |   |   | 882   |   |   | 524   |   |   | 687   |   |
| Approach Delay, s/veh        |   | 34.9  |   |   | 53.0  |   |   | 45.0  |   |   | 37.4  |   |
| Approach LOS                 |   | C   |   |   | D   |   |   | D   |   |   | D   |   |
| Timer                        | 1   | 2   | 3   | 4   | 5   | 6   | 7   | 8   |   |   |   |   |
| Assigned Phs                 | 1   | 2   | 3   | 4   | 5   | 6   | 7   | 8   |   |   |   |   |
| Phs Duration (G+Y+Rc), s     | 18.3  | 30.7  | 14.5  | 42.9  | 9.6   | 39.4  | 21.9  | 35.5  |   |   |   |   |
| Change Period (Y+Rc), s      | 5.0   | 6.0   | 5.0   | 6.0   | 5.0   | 6.0   | 5.0   | 6.0   |   |   |   |   |
| Max Green Setting (Gmax), s  | 30.0  | 32.0  | 28.0  | 32.0  | 25.0  | 32.0  | 28.0  | 35.0  |   |   |   |   |
| Max Q Clear Time (g_c+I1), s | 13.2  | 16.5  | 9.8   | 18.8  | 5.7   | 16.9  | 16.7  | 27.7  |   |   |   |   |
| Green Ext Time (p_c), s      | 0.2   | 8.3   | 0.1   | 4.4   | 0.0   | 9.6   | 0.2   | 1.8   |   |   |   |   |
| <b>Intersection Summary</b>  |   |   |   |   |   |   |   |   |   |   |   |   |
| HCM 2010 Ctrl Delay          |   |   |   | 42.8  |   |   |   |   |   |   |   |   |
| HCM 2010 LOS                 |   |   |   | D   |   |   |   |   |   |   |   |   |



























HCM 2010 Signalized Intersection Summary  
 19: Newcastle Road & Arch Road

Stockton General Plan  
 Existing PM

|                              |  |  |  |  |  |  |  |  |  |  |  |  |
|------------------------------|---|---|---|---|---|---|--|---|---|---|---|---|
| Movement                     | EBL   | EBT   | EBR   | WBL   | WBT   | WBR   | NBL  | NBT   | NBR   | SBL   | SBT   | SBR   |
| Lane Configurations          |  |  |   |  |  |  |  |  |   |   |  |  |
| Traffic Volume (veh/h)       | 3   | 241   | 1   | 30  | 169   | 15  | 3  | 1   | 56  | 114   | 0   | 18  |
| Future Volume (veh/h)        | 3   | 241   | 1   | 30  | 169   | 15  | 3  | 1   | 56  | 114   | 0   | 18  |
| Number                       | 5   | 2   | 12  | 1   | 6   | 16  | 3  | 8   | 18  | 7   | 4   | 14  |
| Initial Q (Qb), veh          | 0   | 0   | 0   | 0   | 0   | 0   | 0  | 0   | 0   | 0   | 0   | 0   |
| Ped-Bike Adj(A_pbT)          | 1.00  |   | 1.00  | 1.00  |   | 1.00  | 1.00   |   | 1.00  | 1.00  |   | 1.00  |
| Parking Bus, Adj             | 1.00  | 1.00  | 1.00  | 1.00  | 1.00  | 1.00  | 1.00   | 1.00  | 1.00  | 1.00  | 1.00  | 1.00  |
| Adj Sat Flow, veh/h/ln       | 1138  | 1509  | 1900  | 1242  | 1329  | 1845  | 1900   | 1599  | 1900  | 1900  | 1845  | 1845  |
| Adj Flow Rate, veh/h         | 4   | 294   | 1   | 37  | 206   | 8   | 4  | 1   | 13  | 139   | 0   | 4   |
| Adj No. of Lanes             | 1   | 1   | 0   | 1   | 1   | 1   | 0  | 1   | 0   | 0   | 1   | 1   |
| Peak Hour Factor             | 0.82  | 0.82  | 0.82  | 0.82  | 0.82  | 0.82  | 0.82   | 0.82  | 0.82  | 0.82  | 0.82  | 0.82  |
| Percent Heavy Veh, %         | 67  | 26  | 26  | 53  | 43  | 3   | 3  | 3   | 3   | 3   | 3   | 3   |
| Cap, veh/h                   | 5   | 614   | 2   | 41  | 583   | 688   | 133  | 22  | 88  | 387   | 0   | 182   |
| Arrive On Green              | 0.00  | 0.41  | 0.41  | 0.03  | 0.44  | 0.44  | 0.12   | 0.12  | 0.12  | 0.12  | 0.00  | 0.12  |
| Sat Flow, veh/h              | 1084  | 1503  | 5   | 1183  | 1329  | 1568  | 102  | 189   | 757   | 1629  | 0   | 1568  |
| Grp Volume(v), veh/h         | 4   | 0   | 295   | 37  | 206   | 8   | 18   | 0   | 0   | 139   | 0   | 4   |
| Grp Sat Flow(s),veh/h/ln     | 1084  | 0   | 1508  | 1183  | 1329  | 1568  | 1048   | 0   | 0   | 1629  | 0   | 1568  |
| Q Serve(g_s), s              | 0.1   | 0.0   | 5.2   | 1.1   | 3.7   | 0.1   | 0.0  | 0.0   | 0.0   | 0.0   | 0.0   | 0.1   |
| Cycle Q Clear(g_c), s        | 0.1   | 0.0   | 5.2   | 1.1   | 3.7   | 0.1   | 2.8  | 0.0   | 0.0   | 2.8   | 0.0   | 0.1   |
| Prop In Lane                 | 1.00  |   | 0.00  | 1.00  |   | 1.00  | 0.22   |   | 0.72  | 1.00  |   | 1.00  |
| Lane Grp Cap(c), veh/h       | 5   | 0   | 616   | 41  | 583   | 688   | 243  | 0   | 0   | 387   | 0   | 182   |
| V/C Ratio(X)                 | 0.85  | 0.00  | 0.48  | 0.91  | 0.35  | 0.01  | 0.07   | 0.00  | 0.00  | 0.36  | 0.00  | 0.02  |
| Avail Cap(c_a), veh/h        | 956   | 0   | 1996  | 587   | 1759  | 2076  | 971  | 0   | 0   | 1141  | 0   | 1038  |
| HCM Platoon Ratio            | 1.00  | 1.00  | 1.00  | 1.00  | 1.00  | 1.00  | 1.00   | 1.00  | 1.00  | 1.00  | 1.00  | 1.00  |
| Upstream Filter(I)           | 1.00  | 0.00  | 1.00  | 1.00  | 1.00  | 1.00  | 1.00   | 0.00  | 0.00  | 1.00  | 0.00  | 1.00  |
| Uniform Delay (d), s/veh     | 18.0  | 0.0   | 7.9   | 17.5  | 6.8   | 5.7   | 14.4   | 0.0   | 0.0   | 15.4  | 0.0   | 14.2  |
| Incr Delay (d2), s/veh       | 79.0  | 0.0   | 2.1   | 23.2  | 1.3   | 0.0   | 0.0  | 0.0   | 0.0   | 0.2   | 0.0   | 0.0   |
| Initial Q Delay(d3),s/veh    | 0.0   | 0.0   | 0.0   | 0.0   | 0.0   | 0.0   | 0.0  | 0.0   | 0.0   | 0.0   | 0.0   | 0.0   |
| %ile BackOfQ(50%),veh/ln     | 0.1   | 0.0   | 2.5   | 0.6   | 1.5   | 0.0   | 0.2  | 0.0   | 0.0   | 1.3   | 0.0   | 0.0   |
| LnGrp Delay(d),s/veh         | 97.1  | 0.0   | 10.0  | 40.6  | 8.1   | 5.8   | 14.4   | 0.0   | 0.0   | 15.6  | 0.0   | 14.2  |
| LnGrp LOS                    | F   |   | A   | D   | A   | A   | B  |   |   | B   |   | B   |
| Approach Vol, veh/h          |   | 299   |   |   | 251   |   |  | 18  |   |   |   | 143   |
| Approach Delay, s/veh        |   | 11.1  |   |   | 12.8  |   |  | 14.4  |   |   |   | 15.6  |
| Approach LOS                 |   | B   |   |   | B   |   |  | B   |   |   |   | B   |
| Timer                        | 1   | 2   | 3   | 4   | 5   | 6   | 7  | 8   |   |   |   |   |
| Assigned Phs                 | 1   | 2   |   | 4   | 5   | 6   |  | 8   |   |   |   |   |
| Phs Duration (G+Y+Rc), s     | 6.2   | 20.8  |   | 9.2   | 5.2   | 21.9  |  | 9.2   |   |   |   |   |
| Change Period (Y+Rc), s      | 5.0   | 6.0   |   | 5.0   | 5.0   | 6.0   |  | 5.0   |   |   |   |   |
| Max Green Setting (Gmax), s  | 18.0  | 48.0  |   | 24.0  | 32.0  | 48.0  |  | 24.0  |   |   |   |   |
| Max Q Clear Time (g_c+I1), s | 3.1   | 7.2   |   | 4.8   | 2.1   | 5.7   |  | 4.8   |   |   |   |   |
| Green Ext Time (p_c), s      | 0.0   | 8.4   |   | 0.5   | 0.0   | 8.5   |  | 0.5   |   |   |   |   |
| <b>Intersection Summary</b>  |   |   |   |   |   |   |  |   |   |   |   |   |
| HCM 2010 Ctrl Delay          |   |   | 12.7  |   |   |   |  |   |   |   |   |   |
| HCM 2010 LOS                 |   |   | B   |   |   |   |  |   |   |   |   |   |

HCM 2010 Signalized Intersection Summary  
 20: Airport Way & French Camp Road

|                              |  |  |  |  |  |  |   |  |  |  |  |  |
|------------------------------|---|---|---|---|---|---|---|---|---|---|---|---|
| Movement                     | EBL   | EBT   | EBR   | WBL   | WBT   | WBR   | NBL   | NBT   | NBR   | SBL   | SBT   | SBR   |
| Lane Configurations          |  |  |  |  |  |  |  |  |  |  |  |  |
| Traffic Volume (veh/h)       | 64  | 385   | 64  | 28  | 240   | 113   | 80  | 295   | 46  | 224   | 259   | 46  |
| Future Volume (veh/h)        | 64  | 385   | 64  | 28  | 240   | 113   | 80  | 295   | 46  | 224   | 259   | 46  |
| Number                       | 1   | 6   | 16  | 5   | 2   | 12  | 7   | 4   | 14  | 3   | 8   | 18  |
| Initial Q (Qb), veh          | 0   | 0   | 0   | 0   | 0   | 0   | 0   | 0   | 0   | 0   | 0   | 0   |
| Ped-Bike Adj(A_pbT)          | 1.00  |   | 0.98  | 1.00  |   | 1.00  | 1.00  |   | 1.00  | 1.00  |   | 1.00  |
| Parking Bus, Adj             | 1.00  | 1.00  | 1.00  | 1.00  | 1.00  | 1.00  | 1.00  | 1.00  | 1.00  | 1.00  | 1.00  | 1.00  |
| Adj Sat Flow, veh/h/ln       | 1583  | 1759  | 1792  | 1367  | 1652  | 1597  | 1743  | 1652  | 1900  | 1827  | 1727  | 1845  |
| Adj Flow Rate, veh/h         | 68  | 410   | 23  | 30  | 255   | 0   | 85  | 314   | 40  | 238   | 276   | 16  |
| Adj No. of Lanes             | 1   | 1   | 1   | 1   | 1   | 1   | 1   | 2   | 0   | 1   | 1   | 1   |
| Peak Hour Factor             | 0.94  | 0.94  | 0.94  | 0.94  | 0.94  | 0.94  | 0.94  | 0.94  | 0.94  | 0.94  | 0.94  | 0.94  |
| Percent Heavy Veh, %         | 20  | 8   | 6   | 39  | 15  | 19  | 9   | 15  | 15  | 4   | 10  | 3   |
| Cap, veh/h                   | 87  | 565   | 479   | 46  | 495   | 406   | 114   | 670   | 85  | 300   | 591   | 537   |
| Arrive On Green              | 0.06  | 0.32  | 0.32  | 0.04  | 0.30  | 0.00  | 0.07  | 0.24  | 0.24  | 0.17  | 0.34  | 0.34  |
| Sat Flow, veh/h              | 1508  | 1759  | 1491  | 1302  | 1652  | 1357  | 1660  | 2805  | 354   | 1740  | 1727  | 1568  |
| Grp Volume(v), veh/h         | 68  | 410   | 23  | 30  | 255   | 0   | 85  | 175   | 179   | 238   | 276   | 16  |
| Grp Sat Flow(s),veh/h/ln     | 1508  | 1759  | 1491  | 1302  | 1652  | 1357  | 1660  | 1570  | 1590  | 1740  | 1727  | 1568  |
| Q Serve(g_s), s              | 3.8   | 17.8  | 0.9   | 2.0   | 11.0  | 0.0   | 4.3   | 8.2   | 8.3   | 11.3  | 10.8  | 0.6   |
| Cycle Q Clear(g_c), s        | 3.8   | 17.8  | 0.9   | 2.0   | 11.0  | 0.0   | 4.3   | 8.2   | 8.3   | 11.3  | 10.8  | 0.6   |
| Prop In Lane                 | 1.00  |   | 1.00  | 1.00  |   | 1.00  | 1.00  |   | 0.22  | 1.00  |   | 1.00  |
| Lane Grp Cap(c), veh/h       | 87  | 565   | 479   | 46  | 495   | 406   | 114   | 375   | 380   | 300   | 591   | 537   |
| V/C Ratio(X)                 | 0.79  | 0.73  | 0.05  | 0.65  | 0.52  | 0.00  | 0.74  | 0.47  | 0.47  | 0.79  | 0.47  | 0.03  |
| Avail Cap(c_a), veh/h        | 490   | 694   | 588   | 423   | 652   | 536   | 732   | 619   | 627   | 767   | 742   | 673   |
| HCM Platoon Ratio            | 1.00  | 1.00  | 1.00  | 1.00  | 1.00  | 1.00  | 1.00  | 1.00  | 1.00  | 1.00  | 1.00  | 1.00  |
| Upstream Filter(I)           | 1.00  | 1.00  | 1.00  | 1.00  | 1.00  | 0.00  | 1.00  | 1.00  | 1.00  | 1.00  | 1.00  | 1.00  |
| Uniform Delay (d), s/veh     | 40.1  | 25.9  | 20.2  | 41.0  | 25.0  | 0.0   | 39.4  | 28.1  | 28.1  | 34.2  | 22.2  | 18.8  |
| Incr Delay (d2), s/veh       | 27.4  | 7.9   | 0.2   | 27.8  | 3.8   | 0.0   | 18.2  | 4.1   | 4.2   | 9.7   | 2.6   | 0.1   |
| Initial Q Delay(d3),s/veh    | 0.0   | 0.0   | 0.0   | 0.0   | 0.0   | 0.0   | 0.0   | 0.0   | 0.0   | 0.0   | 0.0   | 0.0   |
| %ile BackOfQ(50%),veh/ln     | 2.3   | 9.9   | 0.4   | 1.1   | 5.6   | 0.0   | 2.6   | 4.0   | 4.1   | 6.2   | 5.6   | 0.3   |
| LnGrp Delay(d),s/veh         | 67.5  | 33.8  | 20.4  | 68.9  | 28.8  | 0.0   | 57.5  | 32.2  | 32.3  | 43.8  | 24.8  | 18.9  |
| LnGrp LOS                    | E   | C   | C   | E   | C   |   | E   | C   | C   | D   | C   | B   |
| Approach Vol, veh/h          |   | 501   |   |   | 285   |   |   | 439   |   |   | 530   |   |
| Approach Delay, s/veh        |   | 37.8  |   |   | 33.0  |   |   | 37.2  |   |   | 33.2  |   |
| Approach LOS                 |   | D   |   |   | C   |   |   | D   |   |   | C   |   |
| Timer                        | 1   | 2   | 3   | 4   | 5   | 6   | 7   | 8   |   |   |   |   |
| Assigned Phs                 | 1   | 2   | 3   | 4   | 5   | 6   | 7   | 8   |   |   |   |   |
| Phs Duration (G+Y+Rc), s     | 9.9   | 30.8  | 19.9  | 25.6  | 8.1   | 32.7  | 10.9  | 34.5  |   |   |   |   |
| Change Period (Y+Rc), s      | 5.0   | 5.0   | 5.0   | 5.0   | 5.0   | 5.0   | 5.0   | 5.0   |   |   |   |   |
| Max Green Setting (Gmax), s  | 28.0  | 34.0  | 38.0  | 34.0  | 28.0  | 34.0  | 38.0  | 37.0  |   |   |   |   |
| Max Q Clear Time (g_c+I1), s | 5.8   | 13.0  | 13.3  | 10.3  | 4.0   | 19.8  | 6.3   | 12.8  |   |   |   |   |
| Green Ext Time (p_c), s      | 0.3   | 10.3  | 1.6   | 10.2  | 0.1   | 7.9   | 0.5   | 10.4  |   |   |   |   |
| <b>Intersection Summary</b>  |   |   |   |   |   |   |   |   |   |   |   |   |
| HCM 2010 Ctrl Delay          |   |   | 35.5  |   |   |   |   |   |   |   |   |   |
| HCM 2010 LOS                 |   |   | D   |   |   |   |   |   |   |   |   |   |

## **4. List of Commenters**

---

Comments on the Draft EIR were received from the following agencies, organizations, and private individuals. Verbal comments were also recorded at the Public Hearing held at the Planning Commission meeting on August 2, 2018. Each comment letter and comment has been assigned a letter and a number as indicated below. The comments are organized and categorized by:

- A = Agencies and Organizations
- B = Members of the Public

### **4.1 AGENCIES AND ORGANIZATIONS**

|     |  |
|-----|--|
| A01 | Board of Forestry and Fire Protection                |
| A02 | FEMA   |
| A03 | Sierra Club  |
| A04 | California Public Utilities Commission               |
| A05 | Bright Development                                   |
| A06 | Delta Protection Commission                          |
| A07 | Reinvent South Stockton Coalition                    |
| A08 | Sierra Club, Delta -Sierra Group Mother Lode Chapter |
| A09 | Delta Stewardship Council                            |
| A10 | Delta Protection Commission                          |
| A11 | San Joaquin Bike Coalition                           |
| A12 | San Joaquin Council of Governments                   |
| A13 | The Sierra Club                                      |
| A14 | Governor's Office of Planning and Research           |
| A15 | University of the Pacific                            |

### **4.2 MEMBERS OF THE PUBLIC**

|     |                |
|-----|----------------|
| B01 | Dean Plassaras |
| B02 | Colleen Foster |
| B03 | Patrick Wall   |
| B04 | Justin Grant   |
| B05 | Marjie Fries   |

## **LIST OF COMMENTERS**

### **4.3 PUBLIC HEARING**

- C01 Richard Abood
- C02 Eric Parfrey
- C03 Mary Elizabeth
- C04 Shapresha Galloway
- C05 Erin Reynolds
- C06 Paul Plathe
- C07 Yolanda Park
- C08 Margo Praus
- C09 Marj Fries
- C10 Greg Bahr

## 5. Comments and Responses

---

This chapter includes a reproduction of, and responses to, each significant environmental issue raised during the public review period. Comments are presented in their original format in Appendix A, Comment Letters, of this Final EIR, along with annotations that identify each comment number. Comment letters in this chapter follow the same order as listed in Chapter 4, List of Commenters, of this Final Environmental Impact Report (EIR). The comments are organized and categorized by:

- A = Agencies and Organizations
- B = Members of the Public
- C = Public Hearing Verbal Comments (i.e., comments received at the public hearing on the Draft EIR, which was held on August 2, 2018)

Responses to those individual comments are provided in this chapter alongside the text of each corresponding comment. Letters are identified by category and each comment is labeled with the comment reference number in the margin. Where the same comment has been made more than once, a response may direct the reader to another numbered comment and response. Where a response requires revisions to analysis presented in the Draft EIR, these revisions are explained and shown in Chapter 3, Revisions to the Draft EIR, of this Final EIR.

### 5.1 MASTER RESPONSES

Certain topics were raised multiple times in comments on the Draft EIR. In order to minimize duplication and to provide a more comprehensive discussion, “Master Responses” have been prepared for several of these issues. Responses to individual comments reference these master responses as appropriate. Each master response is intended to provide a general response to several comments on the given subject. A particular master response may provide more information than requested by any individual comment. Conversely, the master response may not provide a complete response to a given comment, in which case additional information is contained in the individual response to that comment.

Master responses in this Final EIR address the following issues:

1. Project Merits
2. Development Projections
3. Mitigation
4. Draft EIR Revisions and Recirculation

## COMMENTS AND RESPONSES

### MASTER RESPONSE #1: PROJECT MERITS

The proposed General Plan and Utility Master Plan Supplements (UMPS) constitute the project being analyzed in the Draft EIR. During public review of the Draft EIR, several issues and concerns related to the merits of the project were expressed. These concerns were related to topics such as the project's community consequences or benefits, personal wellbeing and quality of life, and economic or financial issues (referred to hereafter as "project merits"), rather than to the environmental analyses or impacts and mitigations raised in the EIR.

The purpose of the California Environmental Quality Act (CEQA) and the Draft EIR is to fully analyze and mitigate the project's potentially significant physical impacts on the environment. While issues and concerns pertaining to the project's merits are also important to the overall process, the Draft EIR is not intended to address such issues. Pursuant to CEQA, the Draft EIR focuses on the project's physical impacts on the environment.

The City of Stockton's review of environmental issues and the merits of the project are important factors to be discussed and considered in the decision-making process for a project. However, as part of the environmental review process, CEQA only requires the City to respond to environmental issues that are raised and the adequacy of the environmental analysis. The Planning Commission and City Council will hold publicly-noticed hearings to consider action on the General Plan and UMPS for adoption. As part of that process, both the Planning Commission and City Council will consider the EIR's compliance with the requirements of CEQA, as well as project merits issues raised as part of the community's review of the proposed General Plan and UMPS. As part of this review, the City is preparing separate analysis and information related to comments on the merits of the project features for consideration by both the Planning Commission and City Council in a separate document, as discussed further below.

In accordance with Sections 15088 and 15132 of the State CEQA Guidelines, a Final EIR must include a response to comments on the Draft EIR pertaining to environmental issues analyzed under CEQA. Several of the comments provided in response to the Draft EIR express an opinion for, or against, the project or a project alternative, but do not pertain to the adequacy of the analysis or conclusions in the Draft EIR. Rather, these opinions relate to the merits of the project.

Section 15204(a) of the State CEQA Guidelines provides direction for parties reviewing and providing comment on a Draft EIR, as follows:

*In reviewing draft EIRs, persons and public agencies should focus on the sufficiency of the document in identifying and analyzing the possible impacts on the environment and ways in which the significant effects of the project might be avoided or mitigated. Comments are most helpful when they suggest additional specific alternatives or mitigation measures that would provide better ways to avoid or mitigate the significant environmental effects. At the same time, reviewers should be aware that the adequacy of an EIR is determined in terms of what is reasonably feasible, in light of factors such as the magnitude of the project at issue, the severity of its likely environmental impacts, and the geographic scope of the project. CEQA does not require a lead agency to conduct every test or perform all research, study, and experimentation recommended or demanded by commenters. When responding to comments, lead agencies need only respond to significant environmental issues and do not need to*

## COMMENTS AND RESPONSES

*provide all information requested by reviewers, as long as a good faith effort at full disclosure is made in the EIR.*

Therefore, in accordance with Section 15204(a) of the CEQA Guidelines, the City is not required to respond to comments that express an opinion about the project's merits but that do not relate to environmental issues covered in the Draft EIR.

Even though such opinions and comments on the project merits that were received during the EIR process do not require responses in the EIR, as previously noted, they do provide important input in the process of reviewing the project overall. Therefore, merits and opinion-based comment letters are included in the EIR to be available to decision-makers when they consider adopting the General Plan and UMPS. The City has prepared a response to those comments in a separate document focused on comments received on the Draft General Plan.

The separate General Plan document includes recommended changes to the General Plan in response to these comments about the project merits. These recommended changes do not pertain to this EIR or CEQA issues; such changes will not change the findings of this EIR or create substantial adverse impacts, as discussed further in the separate document. See also Master Response #4 regarding Draft EIR revisions and recirculation.

### MASTER RESPONSE #2: DEVELOPMENT PROJECTIONS

Several comments stated that the Draft EIR should have analyzed the full amount of development that hypothetically would be allowed under the Draft General Plan beyond the year 2040 and assert that the EIR fails to provide this information. As described on page 3-20 of the Draft EIR, development projections were prepared for a "full buildout" scenario, in which every parcel within the EIR Study Area would be developed with the maximum amount of development allowed under the General Plan, and also for a General Plan horizon-year scenario, which only includes development that is anticipated to occur by the General Plan horizon year of 2040.

As reported on page 3-22 of the Draft EIR, the full buildout scenario includes the following:

- 119,700 new dwelling units
- 50.9 million square feet of new commercial and office space
- 242.4 million square feet of new industrial space

As noted on page 3-20 of the Draft EIR, the full buildout would result in three times more new housing units and over 24 times more new non-residential development in Stockton by 2040 than expected based on land use demand projections, as described further below.

In comparison, based on the methodology described on pages 3-24 to 3-28 and as shown in Table 3-2 of the Draft EIR, the 2040 horizon-year projection includes the following:

- 40,900 new dwelling units
- 13.8 million square feet of new commercial and office space
- 35.6 million square feet of new industrial space

## COMMENTS AND RESPONSES

### 2040 HORIZON-YEAR PROJECTIONS

The horizon-year projections were based on the probable, or reasonably foreseeable, “planning period development” that is described in detail on page 3-24 of the Draft EIR. The planning period development describes the amount of new development that is expected to occur within the planning period through the year 2040. The probable planning period development numbers are based on substantial evidence available in a market study<sup>1</sup> that was conducted at the outset of the General Plan Update. This market study considers housing, population, and job growth forecasts from the California Department of Transportation (Caltrans), the San Joaquin Council of Governments (SJCOG), and the Center for Business Policy Research (CBPR) at the University of the Pacific to identify forecasts for future demands for new residential, retail, office, and industrial space in Stockton. The land use demand forecast for Stockton in 2040 reported in this market study is as follows:

- **Residential:** Between 19,800 and 41,000 new housing units, including between 13,800 and 28,700 new single-family units and between 5,900 and 12,300 new multi-family units. The low-growth scenario is based on Caltrans data and the high-growth scenario is based on SJCOG and CBPR data.
- **Retail:** Between 3.3 and 4.8 million square feet of new retail development. These estimates are based in part on the residential forecast, so the low- and high-growth numbers are affected by the Caltrans, SJCOG, and CBPR data described for the residential forecast above.
- **Office:** Approximately 7.1 million square feet of new office development. This estimate is based on an employment forecast from SJCOG and CBPR.
- **Industrial:** Approximately 6.2 million square feet of new industrial development. This estimate is based on an employment forecast from SJCOG and CBPR.

Based on the evidence described above, only a fraction of the full buildout is likely to occur by 2040. In fact, the above evidence shows that full buildout of the General Plan area will occur many years beyond the General Plan horizon year of 2040. Specifically, if development occurred at the rates anticipated by the land use demands identified in the market study, and continued at those same rates past 2040, it would take many years beyond the 2040 horizon year to build out:

- **Residential** buildout would occur between 2088 and 2139 (range accounts for low- and high-growth scenarios).
- **Retail and office** buildout would occur between 2118 and 2129 (range accounts for low- and high-growth scenarios).
- **Industrial** buildout would occur in 2874.

As discussed on page 3-20 of the Draft EIR, given the significant difference between the horizon-year projections and full buildout, it is extremely unlikely that full buildout could occur by the year 2040. Moreover, in keeping with current California case law that requires local jurisdictions to update their general plans regularly, Stockton will most likely update its General Plan by or before 2040. Therefore,

---

<sup>1</sup> City of Stockton, 2016. *Existing Conditions Technical Memorandum: Market Analysis*, pages 67 to 76, July 20.



## COMMENTS AND RESPONSES

development after 2040 is expected to take place under a revised General Plan, rather than under the proposed General Plan.

CEQA does not require a worst-case analysis, only an analysis of what is reasonably foreseeable. (Laurel Heights, supra, 47 Cal.3d at p. 396.) For example, in *Molano v. City of Glendale*, (2009) 2009 WL 428800, the Court of Appeal rejected claims that the City of Glendale was required to analyze the maximum buildout permitted by a specific plan. The court upheld the City's determination of what was a reasonable buildout scenario because the assumptions were supported by substantial evidence. Similar to *Molano*, the Draft EIR supports the development assumptions with substantial evidence, consisting of the market study described above. Additionally, the concern about the City exceeding the projected development under the General Plan is premature. Subsequent projects under the General Plan will be subject to CEQA review. At that time, a component of the review will include an evaluation of the current state of the buildout under the Plan. Until then, whether the City has reached or exceeded permissible full buildout is not ripe for review. In the case of any long-range plan such as a general plan, "an environmental impact issue is ripe for consideration when it is 'a reasonably foreseeable consequence' of the plan and the agency preparing the plan has 'sufficient reliable data to permit preparation of a meaningful and accurate report on the impact' of the factor in question." (Los Angeles Unified School Dist. v. City of Los Angeles (1997) 58 Cal.App.4th 1019, 1028.) As a result, no additional analysis is considered necessary.

Additionally, the concern about development exceeding the 2040 development projection is premature. A cap on the amount of development that can occur under the proposed General Plan has been included in the General Plan. See below under the heading "Definition of Project" for the full text of proposed Action LU-6.1A, which limits the amount of development that can happen without further environmental review. Proposed Action LU-6.1B ensures that there is a monitoring program in place to monitor future development. The cap on development that is established by Action LU-6.1A cannot be exceeded without additional CEQA environmental review called for by the action. Please see the edits to the Draft EIR Project Description in Chapter 3 of this Final EIR for elaboration on these points.

The reason that the theoretical full buildout of the General Plan is reported in the Draft EIR Project Description is to explain the methodology that was used to develop the 2040 horizon-year development projections. Specifically, to estimate the 2040 development projection, a percentage of the full theoretical buildout potential was distributed among the geographic "study areas" defined through the community participation process for the General Plan update.

As shown in Chapter 3 of this Final EIR, the formatting of Table 3-3 on page 3-26 of the Draft EIR has been refined to highlight how the full theoretical buildout numbers relate to the 2040 horizon-year projection that was evaluated in the EIR. Specifically, the formatting has been changed to clarify how a specific percentage of the full theoretical buildout capacity was assumed to occur by 2040 within each study area. Those 2040 development projections reported in Table 3-3, combined with pending and approved projects, constitute the entirety of the development that was analyzed in the EIR, in conformance with CEQA Guidelines Section 15378(a), which requires that an EIR consider the reasonably foreseeable indirect physical changes in the environment resulting from a project.

## **COMMENTS AND RESPONSES**

### **ROLE OF THE HORIZON-YEAR PROJECTIONS IN EIR ANALYSES**

Although estimates about the location of horizon-year development were made in order to provide the necessary inputs for the traffic model, the main difference between the full buildout and horizon-year development scenarios is one of quantity, not location. Therefore, the horizon-year projection was used in the quantitative analyses, which, as explained on page 3-28 of the Draft EIR, include traffic generation, air pollution emissions, greenhouse gas emissions, noise generation, population growth, and impacts on public services, utilities, and recreation. These analyses are affected by the number of people living and working in Stockton. This is consistent with a reliable analysis, which depends on a reasonable, quantitative estimate of new population and employment. This is also consistent with CEQA, which requires that an EIR evaluate the “reasonably foreseeable” direct and indirect impacts of a proposed project.

Conversely, the analyses for aesthetics, agriculture and forestry resources, exposure to localized air pollution and noise, biological resources, cultural resources, geology, hazards and safety, hydrology and water quality, and land use are based on spatial location only. These analyses consider whether the proposed General Plan would allow any development in a geographic area that could trigger potential impacts, regardless of the quantity. For example, a 10-acre project at a density of 1 dwelling unit per acre (10 units) would convert the same amount of farmland of significance as a 10-acre project in the same location at a density of 20 dwelling units per acre (200 units). Therefore, for spatial analyses, the Draft EIR assumed the disturbance of entire parcels without making speculative assumptions regarding setbacks or site-design. Thus, the horizon-year impacts for spatial impacts would be equal to the full buildout of the proposed General Plan.

### **ECONOMIC AND EDUCATION ENTERPRISE DESIGNATION**

#### **Inclusion in 2040 Development Projection**

Several comments on the Draft EIR stated that the projected 2040 development evaluated in the EIR should include development within the area designated Economic and Education Enterprise. The 2040 development projection does not include development within the area designated Economic and Education Enterprise because the designation itself does not allow development. Any development in that area would reasonably be expected to necessitate a General Plan Amendment, and most likely a Specific Plan, along with project-specific environmental review. The designation is considered a “holding designation” for future development that would undergo additional planning review once a development project is identified.

In addition, there are several other factors that would limit the likelihood that development would actually occur within the Economic and Education Enterprise designation by 2040, including the following:

- On page 2-14 of the Draft General Plan, the Economic and Education Enterprise designation specifies that businesses appropriate for this designation cannot be reasonably accommodated elsewhere within the city limit. Given the land area available for industrial and similar land uses within the city, most conceivable businesses could locate elsewhere within the city limit.

## COMMENTS AND RESPONSES

- In addition to rezoning, development within the Economic and Education Enterprise designation would also require annexation into the city, a cumbersome and costly process. Potential businesses could locate on vacant industrial land within the existing city limit more quickly and less expensively, making that a more attractive option.
- Utility and roadway infrastructure to support future development does not exist in this area, making it more expensive to develop than in areas within the city that already provide such infrastructure.
- Based on input throughout the process, the community strongly supports infill development over development outside the current city limit. This led to the inclusion of numerous policies and actions that support infill and disincentivize development outside the city limit. The most relevant policies and actions are listed below:
  - Action LU-6.1F: Adjust the Public Facilities Fee structure to encourage development in areas where infrastructure is already present and ensure that non-infill pays its fair share of anticipated citywide capital facilities and operational costs.
  - Policy LU-6.2: Prioritize development and redevelopment of vacant, underutilized, and blighted infill areas.
  - Action LU-6.2A: Implement an infill incentive program that encourages infill through expedited permitting, changes in fee structures, and other strategies.
  - Action LU-6.2B: Do not approve future annexations or City utility connections unless they are consistent with the overall goals and policies of the General Plan and do not adversely impact the City's fiscal viability, environmental resources, infrastructure and services, and quality of life.
  - Action LU-6.5A: Require preparation of a fiscal impact analysis for large development projects and annexations to ensure a full accounting of infrastructure and public service costs, and require fiscal mitigations when necessary.

In summary, because the Economic and Education Enterprise designation does not itself allow development, as well as the above considerations, the 2040 development projections evaluated in the EIR do not include development in this area.

### **“Full Buildout” Potential**

Several comments on the Draft EIR focused on the quantity of development that would occur if the area designated Economic and Education Enterprise built out to its maximum theoretical capacity. As described above, the Economic and Education Enterprise designation does not itself allow development. However, for the purpose of disclosing information to the public and decision-makers, the full theoretical buildout potential of the Economic and Education Enterprise designation was included in the overall full buildout disclosure for the EIR Study Area. The full buildout values shown in the EIR are theoretical, and, for the Economic and Education Enterprise designation, they assume that development has gone through additional LAFCO, City, and CEQA review.

As explained on pages 3-22 to 3-23 of the Draft EIR, the reported theoretical full buildout values assume that every parcel is developed with the maximum amount of development allowed under the General

## COMMENTS AND RESPONSES

Plan. Therefore, for all vacant and underutilized parcels, full buildout is estimated by applying the maximum floor area ratio (FAR) and maximum residential density allowed by the designation.

The proposed General Plan identifies a maximum FAR of 0.6 for development in the Economic and Education Enterprise designation. It could allow supportive housing development that is proximate to the job generator, and identifies a maximum density of 24 units per acre for associated residential development. There is a broad spectrum of economic development catalyst projects that could occur in this designation, making a realistic estimate of the amount and type of future development impossible. Therefore, the full theoretical buildout analysis reported in the Draft EIR used a simple, conservative approach of applying the 0.6 FAR to the entire 3,790 acres within this designation (most of which is vacant), in addition to applying the 24 units per acre to 25 percent of the land area to account for associated housing development. These values are theoretical and far beyond any realistic development level anticipated to occur during the 21<sup>st</sup> century. The FAR calculation was applied to the industrial category reported in Table 3-3 on page 3-26 of the Draft EIR, and the density calculation was applied to the multi-family residential category.

## DEFINITION OF PROJECT

Section 15378(a) of the CEQA Guidelines requires that the project definition include the “whole of an action.” In this EIR, the project is defined as the adoption and implementation of the proposed General Plan and UMPS. Implementation of the General Plan includes development that is allowed by the General Plan land use map, as well as adherence to the General Plan policies and actions. Here, the “whole of the action” is the potential adoption of the General Plan and the UMPS, as well as the reasonably foreseeable development that would result from the adoption of those plans. The EIR’s reliance on a horizon-year projection for the quantitative analyses does not risk speculative potentially higher rates of development escaping environmental review.

The Project Draft EIR is a programmatic EIR for the proposed General Plan and UMPS; therefore, it does not serve as project-level environmental analysis for any specific development project. All future development, located within existing city limits or within the Sphere of Influence (SOI), will require discretionary actions, and therefore, be subject to project-specific environmental review as required by CEQA. Project-specific environmental analyses may tier from the General Plan and UMPS EIR. However, as enumerated in General Plan Action LU-6.1A, shown below, if and when approved development reaches the amount of development projected and evaluated in this EIR, additional environmental analysis must be conducted to address any changes to the General Plan buildout assumptions, consistent with CEQA and the CEQA Guidelines. Furthermore, Action LU-6.1B directs the City to monitor the rate of growth to ensure that it does not overburden the City’s infrastructure and services and does not exceed the amounts analyzed in the General Plan EIR. As a result, the proposed actions will prevent the land use assumptions contained in the EIR from being exceeded unless subsequent environmental review is conducted. Because these actions are part of the project, and they require development beyond the amount analyzed in this EIR to be evaluated through subsequent environmental analysis, the horizon-year projections used in the quantitative analyses accurately capture the potential impacts of the whole of the project.

## COMMENTS AND RESPONSES

The full text of proposed Action LU-6.1A is as follows:

*The Envision Stockton General Plan Update Environmental Impact Report (EIR) assumes the following maximum development projections for the year 2040 for the lands located within the Sphere of Influence, including projects that were already approved prior to the General Plan Update, but not yet constructed:*

- 40,900 new dwelling units.
- 13.8 million square feet of new commercial and office space.
- 35.6 million square feet of new industrial space.

*When approved development within the city reaches the maximum number of residential units or any of the non-residential square footages projected in the General Plan EIR, require that environmental review conducted for any subsequent development project address growth impacts that would occur due to development exceeding the General Plan EIR's projections. This does not preclude the City, as lead agency, from determining that an EIR would be required for any development in the Sphere of Influence to the extent required under the relevant provisions of CEQA (e.g., Section 21166 and related guidelines). The City will conduct the appropriate scoping at the time of initial study for any project, all in accordance with these requirements.*

### MASTER RESPONSE #3: MITIGATION

Several comments received on the Draft EIR expressed concerns about the significant and unavoidable impact findings and in some cases suggest additional mitigation measures to reduce these impacts.

Under CEQA, the decision as to whether an environmental effect should be considered significant is reserved to the discretion of the City of Stockton acting as the lead agency based on substantial evidence in the record as a whole, including the views held by members of the public. An ironclad definition of significant effect is not always possible because the significance of an activity may vary with the setting. The analysis in the Draft EIR is based on scientific and factual data which has been reviewed by the lead agency and reflects its independent judgment and conclusions.<sup>2</sup>

As summarized on pages 6-3 and 6-4 of the Draft EIR, implementation of the proposed General Plan and UMPS has the potential to generate 11 significant and unavoidable environmental impacts. Specifically, significant and unavoidable impacts were identified in Chapters 4.2, Agricultural and Forestry Resources; 4.3, Air Quality; 4.7, Greenhouse Gas Emissions; 4.11, Noise; 4.12, Population and Housing; and 4.14, Transportation and Traffic.

Accordingly, as required by CEQA<sup>3</sup> and the CEQA Guidelines,<sup>4</sup> the Draft EIR proposes and describes mitigation measures designed to minimize, reduce, or avoid each identified potentially significant impact whenever it is feasible to do so. The term “feasible” is defined in CEQA<sup>5</sup> to mean, “capable of being

---

<sup>2</sup> California Code of Regulations, Title 14, Division 6, Chapter 3, Section 15064(b).

<sup>3</sup> Public Resources Code, Section 21002.1(b).

<sup>4</sup> California Code of Regulations, Title 14, Division 6, Chapter 3, Section 15126.4.

<sup>5</sup> Public Resources Code, Section 21061.1.

## COMMENTS AND RESPONSES

accomplished in a successful manner within a reasonable period of time, taking into account economic, environmental, social, and technological factors.” Consistent with the CEQA Guidelines, this EIR identifies feasible mitigation measures even if they will not reduce the impact to a less-than-significant level.<sup>6</sup>

The CEQA Guidelines prohibit the formulation of mitigation measures to be deferred until some future time. As such the mitigation measures described in this EIR specify performance standards to mitigate the significant effect of the proposed project or show how mitigation can be accomplished in more than one specified way.<sup>7</sup>

The mitigation measures described in this EIR are fully enforceable through permit conditions, agreements, or other legally binding instruments, and impacts are further mitigated by mandatory General Plan policies and actions that include the words “shall” or “prohibit.” Given that CEQA permits the adoption of a plan to have mitigation measures incorporated into a plan, the proposed General Plan and UMPS have been developed to be largely self-mitigating through the incorporation of goals, policies and actions designed to protect, preserve, and enhance environmental resources that are fully enforceable at the discretion of the decision-makers, and as a result, there are few impacts that would occur solely on the basis of adoption of the General Plan and UMPS.<sup>8</sup> Generally, regional growth and development that would occur outside of the City’s jurisdiction, combined with approved development projects over which the proposed General Plan has no control, contribute significantly to the impacts identified in the Draft EIR that result from increased traffic and associated secondary impacts from vehicle miles traveled (VMT), including air quality, greenhouse gases (GHGs), and noise impacts.

Given that CEQA does not require mitigation measures for impacts that are not found to be significant, the mitigation measures in this EIR are only for impacts that were found to be significant.<sup>9</sup> Furthermore, the mitigation measures in this EIR have a direct nexus (i.e., connection) between the mitigation measure and the significant impact (*Nollan v. California Coastal Commission*, 483 U.S. 825 (1987))<sup>10</sup> and the mitigation measures are “roughly proportional” to the significant impacts of the proposed project (*Dolan v. City of Tigard*, 512 U.S. 374 (1994)).<sup>11</sup>

The CEQA Guidelines define “mitigation” as including: (1) avoiding the impact altogether by not taking a certain action or parts of an action; (2) minimizing impacts by limiting the degree or magnitude of an action and its implementation; (3) rectifying the impact by repairing, rehabilitating, or restoring the impacted environment; (4) reducing or eliminating the impact over time by preservation and maintenance operations during the life of the action; and (5) compensating for the impact by replacing or providing substitute resources or environments.<sup>12</sup> While, by definition, mitigation may be imposed to require changes be made to the proposed project for purposes of minimizing environmental impacts, the

---

<sup>6</sup> California Code of Regulations, Title 14, Division 6, Chapter 3, Section 15126.2(b).

<sup>7</sup> California Code of Regulations, Title 14, Division 6, Chapter 3, Section 15126.4(a)(1)(B).

<sup>8</sup> Public Resources Code, Section 21081.6(b) and California Code of Regulations, Title 14, Division 6, Chapter 3, Section 15126.4(a)(2).

<sup>9</sup> California Code of Regulations, Title 14, Division 6, Chapter 3, Section 15126.4(a)(3).

<sup>10</sup> California Code of Regulations, Title 14, Division 6, Chapter 3, Section 15126.4(a)(4)(A).

<sup>11</sup> California Code of Regulations, Title 14, Division 6, Chapter 3, Section 15126.4(a)(4)(B).

<sup>12</sup> California Code of Regulations, Title 14, Division 6, Chapter 3, Section 15370.

## COMMENTS AND RESPONSES

proposed mitigation measures in this EIR do not alter the description of the project contained in Chapter 3, Project Description, of the Draft EIR, or the actual project analyzed. Rather, the purpose of the Draft EIR is to fully disclose the environmental impacts of the project as proposed. Consistent with the CEQA Guidelines, where there are impacts that cannot be avoided without imposing changes to the project's design; the EIR identifies the impact and the reasons why the project is being proposed, notwithstanding the impact.<sup>13</sup>

Under CEQA, there are occasions that "feasible" mitigation is not available. If the City of Stockton, acting as the lead agency, determines that a mitigation measure cannot be legally imposed, the measure need not be proposed or analyzed. Instead, the EIR may simply reference that fact and briefly explain the reasons underlying the lead agency's determination.<sup>14</sup> When a lead agency approves a project that would result in significant and unavoidable impacts that are disclosed in the EIR, the agency must state in writing its reasons for supporting the approved action,<sup>15</sup> including the views held by members of the public.<sup>16</sup> This statement of overriding considerations must be supported by substantial information in the record, including the EIR. The City of Stockton may approve the proposed project even though the proposed project would cause a significant effect on the environment if the agency makes a fully informed and publicly disclosed decision that shows there is no feasible way to lessen or avoid the significant effect and specifically identify how the expected benefits from the proposed project outweigh the mitigation measure of reducing or avoiding the significant environmental impacts of the proposed project.<sup>17</sup>

Because the proposed project would result in significant and unavoidable impacts and would result in the conversion of some agricultural and vacant lands to residential, commercial, and industrial uses, and the intensification of underutilized areas, the City would be required to adopt a statement of overriding considerations if it approves the project.<sup>18</sup>

Some comments on the Draft EIR provide specific examples of modifications to recommended mitigations in the Draft EIR and suggest new mitigation measures that could potentially reduce significant impacts or further reduce the already less-than-significant environmental impacts of the project. Not every suggested change or new mitigation measure was added to the EIR, given that CEQA does not require a lead agency to conduct every test or perform all research, study, and experimentation recommended or demanded by commenters, so long as a good faith effort at full disclosure is made in the EIR.<sup>19</sup> Responses to comments regarding mitigation measures, including discussions on infeasible mitigation measures, the inclusion of feasible mitigation measures that are applied but don't fully reduce impacts, revisions to existing mitigation measures, and new mitigation measures, have been addressed in the individual comments, and are provided in Table 5-1.

---

<sup>13</sup> California Code of Regulations, Title 14, Division 6, Chapter 3, Section 15126.2(b).

<sup>14</sup> California Code of Regulations, Title 14, Division 6, Chapter 3, Section 15002 and 15126.4(a)(5).

<sup>15</sup> California Code of Regulations, Title 14, Division 6, Chapter 3, Section 15093(b).

<sup>16</sup> California Code of Regulations, Title 14, Division 6, Chapter 3, Section 15064(a).

<sup>17</sup> California Code of Regulations, Title 14, Division 6, Chapter 3, Section 15043.

<sup>18</sup> California Code of Regulations, Title 14, Division 6, Chapter 3, Sections 15064(a)(2), 15091 and 15093.

<sup>19</sup> California Code of Regulations, Title 14, Division 6, Chapter 3, Section 15204(a).

## COMMENTS AND RESPONSES

Additionally, Table 2-1 in Chapter 2, Report Summary, of this Final EIR presents a summary of impacts and mitigation measures identified in the Draft EIR, including those that have been revised and any new mitigation measures that have been added in response to comments made on the Draft EIR. It is organized to correspond with the environmental issues discussed in Chapter 4, Environmental Evaluation, of the Draft EIR. These revisions do not affect any conclusions or significance determinations provided in the Draft EIR.

## MASTER RESPONSE #4: DRAFT EIR REVISIONS AND RECIRCULATION

During the review period for the Draft EIR, several comments requested that the Draft EIR be revised and recirculated based on their comments or general opinions about the Draft EIR or how the project should be changed.

Section 15204(a) of the CEQA Guidelines provides that CEQA does not require a lead agency to conduct every test or perform all research, study, and experimentation recommended or demanded by commenters.

Section 15003 also explains the emphasis of CEQA upon good-faith efforts at full disclosure rather than technical perfection:

*(i) CEQA does not require technical perfection in an EIR, but rather adequacy, completeness, and a good-faith effort at full disclosure. A court does not pass upon the correctness of an EIR's environmental conclusions, but only determines if the EIR is sufficient as an informational document. (Kings County Farm Bureau v. City of Hanford (1990) 221 Cal.App.3d 692).*

*(j) CEQA requires that decisions be informed and balanced. It must not be subverted into an instrument for the oppression and delay of social, economic, or recreational development or advancement. (Laurel Heights Improvement Assoc. v. Regents of U.C. (1993) 6 Cal.4th 1112 and Citizens of Goleta Valley v. Board of Supervisors (1990) 52 Cal.3d 553).*

Sections 15204(a) and 15003 reflect judicial interpretation of CEQA. Under CEQA, lead agencies need only respond to significant environmental issues, and do not need to provide all information requested by reviewers, so long as a good faith effort at full disclosure is made in the EIR.

Accordingly, the Draft EIR is not revised and recirculated simply because there is a request from a commenter to do so. Under CEQA, recirculation is only required when the lead agency adds “significant new information” to an EIR, after the public comment period but prior to certification (*Laurel Heights Improvement Association v. Regents of the University of California* (1993) 6 Cal.4th 1112, 1128). “Information” can include changes in the project or environmental setting, as well as additional data or other information, while “significant new information” requiring recirculation can include, for example, a disclosure showing any of the following:<sup>20</sup>

---

<sup>20</sup> Public Resources Code, Section 21092.1 and California Code of Regulations, Title 14, Division 6, Chapter 3, Section 15088.5(a).



## COMMENTS AND RESPONSES

- A new significant environmental impact would result from the project or from a new mitigation measure proposed to be implemented.
- A substantial increase in the severity of an environmental impact would result unless mitigation measures are adopted that reduce the impact to a level of insignificance.
- A feasible project alternative or mitigation measure considerably different from others previously analyzed would clearly lessen the environmental impacts of the project, but the project’s proponents decline to adopt it.
- The Draft EIR was so fundamentally and basically inadequate and conclusory in nature that meaningful public review and comment were precluded. (*Mountain Lion Coalition v. Fish and Game Com.* (1989) 214 Cal.App.3d 1043)

In *Laurel Heights*, the California Supreme Court interpreted this “significant new information” standard and explicitly rejected the proposition that “any new information” triggers recirculation; recirculation is intended to be an exception, not the general rule. Thus, recirculation is required only if changes to the Draft EIR deprived the public of a meaningful opportunity to comment on a substantial adverse environmental effect of the project.

Given that recirculation is not required where the new information added to the EIR merely clarifies, amplifies, or makes insignificant modifications in an adequate EIR<sup>21</sup> and because no “substantial adverse” impact would result from any of the revisions of the Draft EIR shown in Chapter 3, Revisions to the Draft EIR, of this Final EIR,<sup>22</sup> recirculation would not be required.

## 5.2 INDIVIDUAL RESPONSES

Responses to individual comments are presented in Table 5-1, below. Individual comments are reproduced from the original versions in Appendix A, along with the comment numbers shown in the appendix, followed by the response.

---

<sup>21</sup> California Code of Regulations, Title 14, Division 6, Chapter 3, Section 15088.5(b).

<sup>22</sup> California Code of Regulations, Title 14, Division 6, Chapter 3, Section 15088.5(e).

## COMMENTS AND RESPONSES

TABLE 5-1 RESPONSE MATRIX

| Comment #                         | Date             | Comment  | Response   |
|-----------------------------------|------------------|--|--|
| <b>Agencies and Organizations</b> |                  |  |  |
| <b>A01</b>                        | <b>7/2/2018</b>  | <b>Board of Forestry and Fire Protection</b>   |  |
| A01-1                             |                  | As the City of Stockton does not have any Very High Fire Hazard Severity Zones, the Board of Forestry and Fire Protection has no recommendations.  | This comment states that the City of Stockton does not have any Very High Fire Hazard Severity Zones and does not address the adequacy of the Draft EIR. The comment is acknowledged for the record and will be forwarded to the decision-making bodies as part of the Final EIR for their consideration in reviewing the project. No further response is required.      |
| <b>A02</b>                        | <b>7/12/2018</b> | <b>FEMA</b>  |  |
| A02-1                             |                  | <p>This is in response to your request for comments regarding Notice of Availability of Draft Environmental Impact Report, City of Stockton, Envision Stockton 2040 General Plan Update and Utility Master Plan Supplements.</p> <p>Please review the current effective countywide Flood Insurance Rate Maps (FIRMs) for the County of San Joaquin (Community Number 060299), Maps revised October 20, 2016 and City of Stockton (Community Number 060302), Maps revised October 16, 2009. Please note that the City of Stockton, San Joaquin County, California is a participant in the National Flood Insurance Program (NFIP). The minimum, basic NFIP floodplain management building requirements are described in Vol. 44 Code of Federal Regulations (44 CFR), Sections 59 through 65.</p>   | This comment describes the Flood Insurance Rate Maps for San Joaquin County and does not address the adequacy of the Draft EIR. The comment is acknowledged for the record and will be forwarded to the decision-making bodies as part of the Final EIR for their consideration in reviewing the project. No further response is required.                               |
| A02-2                             |                  | <ul style="list-style-type: none"> <li>All buildings constructed within a riverine floodplain, (i.e., Flood Zones A, AO, AH, AE, and A1 through A30 as delineated on the FIRM), must be elevated so that the lowest floor is at or above the Base Flood Elevation level in accordance with the effective Flood Insurance Rate Map.</li> <li>If the area of construction is located within a Regulatory Flood way as delineated on the FIRM, any development must not increase base flood elevation levels. The term development means any man-made change to improved or unimproved real estate, including but not limited to buildings, other structures, mining, dredging, filling, grading, paving, excavation or drilling operations, and storage of equipment or materials. A hydrologic and hydraulic analysis must be performed prior to the start of development, and must demonstrate that the development would not cause any rise in base flood levels. No rise is permitted within regulatory floodways.</li> <li>Upon completion of any development that changes existing Special Flood Hazard Areas, the NFIP directs all participating communities to submit the appropriate hydrologic and hydraulic data to FEMA for a FIRM revision. In</li> </ul> | This comment provides information on floodplains and construction methods related to flood zones. The comment does not address the adequacy of the Draft EIR. The comment is acknowledged for the record and will be forwarded to the decision-making bodies as part of the Final EIR for their consideration in reviewing the project. No further response is required. |

**COMMENTS AND RESPONSES**

| Comment #  | Date             | Comment   | Response   |
|------------|------------------|---|--|
|            |                  | accordance with 44 CFR, Section 65.3, as soon as practicable, but not later than six months after such data becomes available, a community shall notify FEMA of the changes by submitting technical data for a flood map revision. To obtain copies of FEMA's Flood Map Revision Application Packages, please refer to the FEMA website at <a href="http://www.fema.gov/business/nfip/forms.shtm">www.fema.gov/business/nfip/forms.shtm</a> .   |  |
| A02-3      |                  | Many NFIP participating communities have adopted floodplain management building requirements which are more restrictive than the minimum federal standards described in 44 CFR. Please contact the local community's floodplain manager for more information on local floodplain management building requirements. The Stockton floodplain manager can be reached by calling James Wong, Senior Civil Engineer, at (209) 93 7-8110. The San Joaquin County floodplain manager can be reached by calling John Maguire, Engineering Services Manager, at (209) 953-7617 . If you have any questions or concerns, please do not hesitate to call Brian Trushinski of the Mitigation staff at (510) 627-7183.   | This comment provides information about local floodplain management and does not address the adequacy of the Draft EIR. The comment is acknowledged for the record and will be forwarded to the decision-making bodies as part of the Final EIR for their consideration in reviewing the project. No further response is required. |
| <b>A03</b> | <b>7/23/2018</b> | <b>Sierra Club</b>  |  |
| A03-1      |                  | <p>Re: Initial Comments on Updated Stockton General Plan and DEIR (Envision Stockton)</p> <p>Chair Hull and Members of the Commission:</p> <p>We are writing you this letter to document our initial impressions and comments to the Updated Stockton General Plan and DEIR, for consideration by your Commission when you hold the first meeting on the plan.</p> <p>The members of both our groups have been actively involved in this update process since it was initiated several years ago. We have previously submitted letters to the Commission and City Council in April, June, and July, 2017.</p> <p>To sum up our impressions of the Envision Stockton program:</p> <p>There is a world of difference between the manner in which the City staff and consultants are treating public participation in this most recent update, compared to the disastrous process and results that led to the previous 2007 General Plan update. Citizen involvement has been encouraged and respected. The opinions of the majority of those that participated in workshops over the last 18 months have largely been reflected in the text</p> | The comment expresses a general opinion about the proposed project and does not address the adequacy of the Draft EIR. Please see Master Response #1, Project Merits, in Section 5.1 of this chapter.  |

## COMMENTS AND RESPONSES

| Comment # | Date | Comment   | Response |
|-----------|------|---|----------|
|           |      | <p>and policies of the proposed plan, with one notable exception: the growth planned north of Eight Mile Road.</p>  |          |
|           |      | <p><b>Initial Comments on General Plan Goals and Policies</b><br/>                     The proposed plan is a much more concise and focused document than the over-stuffed 2007 plan. This is good, since an overly lengthy plan with hundreds of policies is much more difficult to apply to land use and other planning decisions on a day to day basis. We especially appreciate Appendix A, “A Summary of Policies and Actions by Topic,” which is very handy (although we note that there doesn’t seem to be “Agricultural and Natural Resources” and “Public Facilities and Services” sections, which should be added.)</p> |          |
|           |      | <p>The largest single change in the new plan is the elimination of thousands of acres on the land use map of “Village” growth planned on prime agricultural lands at the periphery of the city. This feature made the 2007 plan an environmental disaster that could never, and would never, have been built. Soon after the 2007 plan was adopted the real estate market crashed, and housing demand in Stockton is now very different than what it was during the booming years of the early and mid-2000s.</p>   |          |
|           |      | <p>The new plan rightfully heard the strong pleas from residents, business people, and concerned organizations to ensure that the new plan concentrated on infill growth, especially in the downtown and existing neighborhoods, and stop growth sprawling into the adjacent farmlands. (However, the inappropriate plans for substantial housing growth north of Eight Mile Road is grossly inconsistent with the infill goals and policies.)</p>  |          |
|           |      | <p>In our last letter to the Commission dated June 9, 2017, we offered some dozen recommendations for additional changes to the preliminary list of General Plan goals and policies. We are pleased to see that many of these recommendations were accepted and are reflected in the draft plan. The addition of the Public Health section and its policies is also much appreciated. This was requested by many of our allies.</p>   |          |
|           |      | <p>However, some recommendations were not accepted, and we repeat those and a couple additional policies that we have advocated in the past. We will continue to add to this list as we dive deeper into the plan.</p> <ul style="list-style-type: none"> <li>• Add a “Sustainability/Climate Change” (or similar title) section and put in relevant goals, as noted below;</li> </ul>  |          |

**COMMENTS AND RESPONSES**

| Comment # | Date | Comment  | Response  |
|-----------|------|--|---|
|           |      | <ul style="list-style-type: none"> <li>• Add goals that address climate change, greenhouse gas reduction, and clean energy (there are a few related goals and policies in the draft plan, e.g., POLICY CH-5.1 “Accommodate a changing climate through adaptation and resiliency planning and projects,” but several more should be added from the Climate Action Plan (we appreciate that the city has committed to updating the CAP);</li> <li>• Add a goal that addresses need for City resiliency programs to combat climate changes due to rising sea levels and increased flood risk;</li> <li>• Add a goal that addresses jobs/housing balance (POLICY LU-6.4 “Ensure that land use decisions balance travel origins and destinations in as close proximity as possible” is a start, but more specificity and consistency with the land use map is needed).;</li> <li>• Add goals and policies (from Housing Element?) that address affordable housing and inclusionary housing;</li> <li>• Add goals and policies that specifically support the redevelopment of struggling shopping centers into mixed use projects with a strong component of affordable housing;</li> <li>• Add goals and policies that specifically address City/developer funding for increased transit services (this is required by the Settlement Agreement);</li> <li>• Strengthen goals and policies related to curtailing sprawl at the City fringes and conservation of agricultural resources, and set forth detailed policies and a realistic plan to establish an “ag belt” between Stockton and Lodi, centered along Armstrong Road, and designate the ag buffer on the land use map (the existing POLICY LU-5.3 and Action LU-5.3B “Coordinate with San Joaquin County to develop a plan for a greenbelt or community separator around the city” is very vague, and will never get the job done. There should be an explicit policy to target ag lands just outside the Lodi and Stockton Spheres as a high priority for ag conservation easements, paid for by mitigation fees); and</li> <li>• Add more specific goals related to crime prevention as recommended by Commissioners and members of the public.</li> </ul> |   |
| A03-2     |      | <p><b>What’s Happening North of Eight Mile Road?</b><br/>                     As expected, the most intensive fight to establish and memorialize the city’s new progressive infill-oriented growth policies is being fought over familiar territory: the 17,500 acres of agricultural lands north of 8 Mile Road that are designated in the current General Plan for future “Village” growth. The area includes 3,800 acres of prime ag land owned by the Spanos organization located north of Eight Mile Road on both sides of the I-5 freeway.</p>   | <p>The comment provides background information and does not address the adequacy of the Draft EIR. The comment is acknowledged for the record and will be forwarded to the decision-making bodies as part of the Final EIR for their consideration in reviewing the project. No further response is required.</p> |

## COMMENTS AND RESPONSES

| Comment # | Date | Comment  | Response |
|-----------|------|--|----------|
|           |      | <p>Spanos representatives have been tempting the city in recent years with visions of locating a new super job-generating use such as a technology park, or a major hospital complex, or a new college campus, on the land north of Eight Mile Road.</p>   |          |
|           |      | <p>To recount the history of what has happened related to planning for these lands over the last several years, we quote from our July 21, 2017 letter to the City Council:</p>  |          |
|           |      | <p>Over the last year, your Council and the Planning Commission have heard hundreds of residents express their opinions about future growth patterns in our City through the well-attended workshops and public meetings that were held by City staff and consultants. At three workshops held by the City in September 2016 there was no expressed support for more low density suburban construction on agricultural land outside the existing City limits. Rather, the participants strongly favored future growth concentrated in South and downtown Stockton and supported higher intensity, mixed use, modern buildings, along with multi-family and attached housing types (see Summary of General Plan workshops).</p> |          |
|           |      | <p>The clear support for infill development instead of sprawl is in line with the “Vision Statement” adopted by the City to guide the General Plan program. That statement reads:</p>  |          |
|           |      | <p>“The edges of Stockton will be discrete and clear, agriculture will continue to thrive outside the urbanized city, and Stockton residents will enjoy scenic views of agricultural land. <u>Development and redevelopment of vacant, underutilized, and blighted areas will be prioritized over development that extends into agricultural areas, strengthening the city’s core and preserving the open space that surrounds it.</u>” (emphasis added)</p>   |          |
|           |      | <p>To gauge community support for smart growth policies, CCG created and distributed an online survey in late 2016. The survey asks residents of Stockton about their preferences regarding the city’s growth patterns, and the results to date (over 400 responses) are clear: A strong majority of Stocktonians prefer policies that encourage infill development in existing neighborhoods while discouraging growth outside of city limits. Residents also showed an appetite for policies that create more affordable housing, neighborhoods with access to transit, and complete streets.</p>  |          |

**COMMENTS AND RESPONSES**

| Comment # | Date | Comment  | Response |
|-----------|------|--|----------|
|           |      | <p>With regards to where our city should grow, the results of the CCG survey were clear:</p> <ul style="list-style-type: none"> <li>• A total of 66% of respondents agreed with the statement that “Stockton should not grow north of Eight Mile Road,” compared with 20% that disagreed.</li> <li>• A total of 59% of respondents agreed with the statement that “New growth outside of Stockton City Limits should be restricted,” compared with 19% that disagreed.</li> <li>• At the conclusion of the public meetings in 2016, the consultant prepared three land use alternatives. Alternative C (map attached) was described as “relatively dense infill development,” and “At the edges of the city, this scenario would eliminate the “village” concept from the current General Plan, <u>shrink the current Sphere of Influence, and reserve much of the area beyond the city limit for open space and agricultural uses.</u>” (emphasis added)</li> </ul> |          |
|           |      | <p>All of the Council members agreed that the public wants Alternative C and all Council members expressed support for that alternative, not Alternatives A or B, which proposed urban development north of Eight Mile Road. A “Preferred Land Use Alternative” land use map (dated April 17, 2017) was prepared and distributed (attached).</p>   |          |
|           |      | <p><b>From a Tesla Giga Factory to 26,000 Housing Units</b><br/>                     The City Council at their April 4, 2017 workshop on the General Plan talked extensively about the need to reduce unnecessary growth outside of the city limits. The same meeting included a discussion regarding the extraordinary opportunities that could occur if a major user such as a large (500-acre) Tesla-type plant or a Cal State University campus were to be proposed north of Eight Mile Road (or elsewhere in the City).</p>   |          |
|           |      | <p>So, the original concept was for the city to reserve some land for a unique high-paying employment center that needed more acreage than could be accommodated elsewhere in the city. Housing was never discussed as a component of such a job center. Councilman Holman at the end of the April 4 meeting made a motion that was seconded to direct staff to proceed with Alternative C and “add to it to allow us to take advantage of opportunities that occur within the sphere of influence” by adding some language but that it “would not necessarily say we’re going to develop in that area.”</p>   |          |
|           |      | <p>The Planning Commission discussed these issues at your meetings of June 8</p>   |          |

## COMMENTS AND RESPONSES

| Comment # | Date | Comment  | Response |
|-----------|------|--|----------|
|           |      | <p>and June 22, 2017.</p> <p>On July 25, 2017, the City Council considered three options prepared by staff to implement an economic development strategy by reserving land north of Eight Mile Road. During the discussion, City planning staff noted argued that the amount of land that would be needed for a Tesla factory or a Cal State campus would be in the range of 500 acres. At this point during the meeting the City Manager jumped in to argue forcefully that although only about 500 acres was needed, he urged the Council to designate the entire Spanos holding of 3,800 acres for a huge job-generator, since that would give maximum flexibility to the city and a potential developer. There was still no talk about allowing housing on the land. The City Council went along with the manager’s request.</p> <p>Fast forward to July 2018 and the city releases the proposed General Plan and the DEIR. The draft plan defines the newly re-named “Economic and Education Enterprise” land use designation that applies to the Spanos lands and suddenly housing has been added into the equation, as follows:</p> <p>Development in this designation is intended to support the City’s economic development goals by attracting new businesses, industries, and/or educational institutions that provide high-quality jobs to the local workforce...Businesses envisioned for this designation include those within a Core Business Cluster industry, as specified in the City’s Economic Development Strategic Plan, that provide a significant number of jobs offering wages averaging above Area Median Income, and that cannot be reasonably accommodated elsewhere within the city limit... <u>The designation also allows proximate housing stock that supports the job-generator, including single-family, multi-family, and/or mixed-use dwellings at various levels of affordability, with housing costs that generally correspond to the income levels of the jobs generated by the project...</u> (emphasis added) (page 2-14 of the draft General Plan)</p> <p>The amount of housing that is forecast for the Economic and Education Enterprise zone is quite substantial: <u>26,710 housing units</u>. This amount of housing planned for the land north of Eight Mile Road (or the potential for any housing at all) was never discussed previously by the City Council or by this Planning Commission. The concept of building more housing at this scale north of Eight Mile Road was certainly never discussed at the public meetings we attended.</p> |          |



**COMMENTS AND RESPONSES**

| Comment # | Date | Comment   | Response  |
|-----------|------|---|---|
| A03-3     |      | <p><b>The DEIR Fails to Analyze Impacts Related to Buildout of 3,800 Acres of Ag Land Designated for “Economic and Education Enterprise”</b></p> <p>The fatal flaw of the DEIR comes in its failure to analyze the environmental impacts of any development of the 3,800 acres north of Eight Mile Road, as well as other development. The DEIR justifies this failure by offering a false distinction between “spatial” and “quantitative” inputs of data. The DEIR notes “analyses that require a quantitative estimate of growth include traffic generation, air pollution emissions, greenhouse gas emissions, noise generation, population growth, and impacts on public services and utilities and recreation.... For these analyses, the horizon-year projection (i.e., the projected amount of development that could occur under the proposed General Plan through its horizon year of 2040) was considered “reasonably foreseeable” and was used in the analysis” (page 3-28).</p> <p>However, as we will see in the Table 3-3 from the DEIR (attached) and described below, the DEIR assumes that there will be <u>NO</u> development of any kind within the 3,800 acres between now and 2040, so impacts related to these “quantitative” topics are ignored in the DEIR, in violation of CEQA.</p> <p>In contrast, “analyses that are based on spatial location only include aesthetics, agriculture, exposure to localized air pollution and noise, biological resources, cultural resources, geology, hazards and safety, hydrology and water quality, and land use... For these analyses, the question is not <i>how much</i> development the General Plan would allow, but <i>where</i> that development could potentially be located. Therefore, all potential development allowed by the land use map of the proposed General Plan was evaluated to assess impacts in these topics (i.e., full buildout of the proposed General Plan)” (page 3-28).</p> <p>So, the DEIR includes some perfunctory analysis of the “spatial” topics related to development of the 3,800 acres, but the discussion is only limited to these topics.</p> <p>Table 3-3 in the DEIR (attached) is the key to understanding which development areas in the City plan have been analyzed for the full range of CEQA impacts and which areas have been ignored because projected growth is presumed to not occur until after the year 2040. The table lists the development assumptions for Study Area #1 (Eight Mile Road) in the first row. (The Study Area is defined as the area north of Eight Mile Road, as well as the “Bear Creek” projects area south of Eight Mile Road.)</p> | Please see Master Response #2, Development Projections, in Section 5.1 of this chapter. |

## COMMENTS AND RESPONSES

| Comment # | Date | Comment   | Response   |
|-----------|------|---|--|
|           |      | <p>The table indicates that the total amount of growth that is projected to occur by 2040 in the Eight Mile Road Study Area is 1,380 single family homes, 1,200 multi-family units, and 39,000 square feet of commercial space. According to staff and the DEIR consultant, this amount of growth is assumed to be located in the Bear Creek area south of Eight Mile Road, and that no growth by 2040 is located on the 3,800 acres of Spanos lands north of Eight Mile Road.</p> <p>However, for the “full buildout” of the plan beyond year 2040, development on the Spanos lands is assumed to include 2,560 single family homes (3,940 minus the Bear Creek homes), a whopping 24,150 multi-family units, 158,000 square feet of commercial space, and over 74 million square feet of “industrial” space (which presumably includes institutional or educational uses).</p> <p>Notably, assuming 3.23 people per household, the assumption that 26,710 housing units would be constructed north of Eight Mile Road under the full buildout of the plan is equivalent to adding over 86,000 new residents to the city! This DEIR fails to analyze any of the environmental impacts of this amount of new housing growth related to traffic generation, air and greenhouse gas emissions, noise, population growth, and impacts on public services and utilities and recreation.</p> |  |
| A03-4     |      | <p><b>“Piecemealing” a Project Is Not Allowed Under CEQA</b><br/>                     City staff and the consultant have justified the DEIR’s failure to analyze traffic and other impacts for projects assumed not to occur by 2040 (including the 3,800 acres north of Eight Mile Road) by promising that full environmental analysis and mitigation of impacts will be prepared if and when applications are submitted sometime in the future. This “piecemealing” or segmenting of a project and the deferral of environmental analysis is specifically prohibited by the California Environmental Quality Act and more than forty years of case law.</p> <p>As described by the Association of Environmental Professionals, piecemealing or segmenting means dividing a project into two or more pieces and evaluating each piece in a separate environmental document, rather than evaluating the whole of the project in one environmental document. This is explicitly forbidden by CEQA, because dividing a project into a number of pieces would allow a Lead Agency to minimize the apparent environmental impacts of a project by evaluating individual pieces</p>  | <p>Please see Master Response #2, Development Projections, in Section 5.1 of this chapter, including the information provided under the heading "Definition of Project," which relates to piecemealing and ensuring that the EIR consider the "whole of the project." See also the response to Comment A13-17.</p> |

**COMMENTS AND RESPONSES**

| Comment # | Date | Comment  | Response |
|-----------|------|--|----------|
|           |      | <p>separately, each of which may have a less-than- significant impact on the environment, but which together may result in a significant impact. Segmenting a project may also hinder developing comprehensive mitigation strategies.<sup>1</sup></p>  |          |
|           |      | <p>In essence, this DEIR analysis has arbitrarily divided the buildout of the General Plan into two separate projects: the development that is assumed to occur by 2040, and the remaining development that is expected after that date. The downfall of the DEIR analysis is that the housing growth assumed by 2040 is 41,400 units, which is only one third of the total amount of housing allowed by the General Plan land use map (120,180 units). For non-residential growth, the discrepancy is even larger: only 17% of the 293,311,000 square feet of commercial and industrial is assumed by 2040. Thus, based on the housing projections alone, the traffic, air quality, public services and other environmental impacts of the buildout of the plan are potentially underestimated by two-thirds.</p> |          |
|           |      | <p>The DEIR must analyze the impacts of the full level of residential, commercial, and industrial uses approved by the General Plan. The maximum level of development approved by the General Plan is the project being approved, not a “reasonably foreseeable” year 2040 scenario. Defining and analyzing “the whole of the project” being approved is a long-standing requirement under CEQA. The courts have consistently held that an EIR must examine a project’s potential to impact the environment, even if the development may not ultimately materialize. <i>Bozung v. Local Agency Formation Com.</i> (1975) 13 Cal.3d 263, 279, 282.</p>  |          |
|           |      | <p>Because general plans, such as the updated Stockton General Plan, serve as the crucial “first step” toward approval of any particular development project, the EIR must evaluate the amount of development actually allowed by the plan. <i>City of Carmel-By-the-Sea v. Bd. of Supervisors of Monterey County</i> (1986) 183 Cal.App.3d 229, 244; <i>City of Redlands v. County of San Bernardino</i> (2002) 96 Cal.App.4th 398, 409. Thus, an agency may not avoid analysis of such development merely because historic and projected land use trends indicate that the development might not occur.</p>  |          |
|           |      | <p>In a 2005 case with facts analogous to the present situation, the Placer County Superior Court held that the agency must analyze the full amount of development being approved under a community plan (<i>Sierra Watch et al. v. Placer County et al.</i> (Placer County Superior Court No. SCV 16652)). Like the</p>   |          |

## COMMENTS AND RESPONSES

| Comment # | Date | Comment  | Response   |
|-----------|------|--|--|
|           |      | <p>DEIR here, Placer County’s EIR assumed that full build-out of the plan would be unrealistic. The EIR reduced the level of development in the project description to a more “realistic” level that was likely to occur in the plan area. The judge found the project description to be inadequate and held, “The time to study the likely affects of specific and cumulative impacts is at the time that the potential for development is known, whether or not that development actually occurs” (citing <i>Christward Ministry v. Superior Court</i> (1986) 184 Cal.App.3d 180, 194; and <i>Bozung</i>).</p> <p><sup>1</sup> Association of Environmental Professionals, CEQA Portal Topic Paper posted at: <a href="https://ceqaportal.org/tp/Project%20Description%20003-23-161.pdf">https://ceqaportal.org/tp/Project%20Description%20003-23-161.pdf</a>.</p> |  |
| A03-5     |      | <p><b>A Proposal</b></p> <p>If the city would like to limit its analysis to a predicted amount of growth, it must also limit the allowable development to that lower level by placing restrictions on growth in the general plan itself. To restrict growth to the “reasonably foreseeable” year 2040 scenario, the city could adopt a general plan policy or policies prohibiting additional housing and commercial development beyond the 2040 projections unless a new environmental impact report has been prepared and an amendment to the plan and/or rezoning is adopted.</p>   | <p>Please see Master Response #2, Development Projections, in Section 5.1 of this chapter. As indicated in the master response, proposed General Plan Action LU-6.1A restricts growth to the 2040 development projection without additional environmental review; the full text of this action is as follows.</p> <p><i>The Envision Stockton General Plan Update Environmental Impact Report (EIR) assumes the following maximum development projections for the year 2040 for the lands located within the Sphere of Influence, including projects that were already approved prior to the General Plan Update, but not yet constructed:</i></p> <ul style="list-style-type: none"> <li>▪ 40,900 new dwelling units.</li> <li>▪ 13.8 million square feet of new commercial and office space.</li> <li>▪ 35.6 million square feet of new industrial space.</li> </ul> <p><i>When approved development within the city reaches the maximum number of residential units or any of the non-residential square footages projected in the General Plan EIR, require that environmental review conducted for any subsequent development project address growth impacts that would occur due to development exceeding the General Plan EIR’s projections. This does not preclude the City, as lead agency, from determining that an EIR would be required for any development in the Sphere of Influence to the extent required under the relevant provisions of CEQA (e.g., Section 21166 and related guidelines). The City will conduct the appropriate scoping at the time of initial study for any project, all in accordance with these requirements.</i></p> |
| A03-6     |      | <p>Over the last eighteen months, we have consistently advocated such an approach to fulfill the city’s desire to set aside land north of Eight Mile Road for a super-job-generator or state university campus. In our letters and in our testimony at the City Council workshop, and again at the Planning Commission in 2017, we explicitly note that we are not opposed to</p>  | <p>The comment expresses a general opinion about the proposed project and does not address the adequacy of the Draft EIR. Please see Master Response #1, Project Merits, in Section 5.1 of this chapter.</p>   |

**COMMENTS AND RESPONSES**

| Comment # | Date | Comment  | Response  |
|-----------|------|--|---|
|           |      | <p>consideration of an “extraordinary” opportunity on lands north of Eight Mile Road. Last year, we recommended that the new General Plan could include a policy that recognizes this opportunity:</p> <p>“The City will consider future amendments to the General Plan for extraordinary growth plans outside the Urban Services Boundary that include significant job generators or public institutions such as a college campus.”</p>   |   |
| A03-7     |      | <p><b>Conclusion</b><br/>                     We will continue to insist that the city approve an updated General Plan and accompanying environmental impact report in conformance with State law. We have offered ample evidence that the existing DEIR, in its current form, does not meet the requirements of the California Environmental Quality Act. The city must direct staff and the consultant to modify the draft plan and the DEIR to meet the State mandate for full disclosure of all impacts and recommend specific measures for all growth allowed under this General Plan, not just some of it.</p>   | <p>This comment is a closing statement that summarizes the content of the letter. See the responses to Comments A03-3 through A03-5. See also Master Response #4, Draft EIR Revisions and Recirculation, in Section 5.1 of this chapter.</p>  |
| A03-8     |      | <p>We noted last year, and reiterate once again, we are totally opposed to any attempt by staff or others to back off the previous commitment by the city to designate the lands north Eight Mile Road for Agriculture/Open Space uses, and instead propose massive amounts of housing. We are opposed to a designation of any of these lands as “Economic and Education Enterprise,” with no meaningful policies or restrictions on developing the land prematurely.</p> <p>The lack of any specific policies that guide the development of lands north of Eight Mile Road leave a huge loophole in this General Plan that could be exploited by future City Councils. For example, a future Council could approve thousands of units of housing with the promise that a major job generator is about to commit to build in the area. There is nothing in this plan that would restrict the Spanos organization from applying for single or multiple family housing in the next five years. There is nothing that would preclude the Spanos group from applying to expand the existing Spanos West subdivisions north of Eight Mile Road.</p> | <p>The comment expresses a general opinion about the proposed project and does not address the adequacy of the Draft EIR. Please see Master Response #1, Project Merits, in Section 5.1 of this chapter.</p>  |
| A03-9     |      | <p>We are disappointed that we have come so far from the last disastrous General Plan yet we still are encountering these last minute manipulations to add housing north of Eight Mile Road, which has received no meaningful public review and discussion.</p> <p>Thank you for your consideration of these important matters. We look</p>  | <p>The comment expresses a general opinion about the proposed project's process and does not address the adequacy of the Draft EIR. The comment is acknowledged and will be forwarded to the decision-making bodies as part of the Final EIR for their consideration in reviewing the project. No further response is required.</p> |

## COMMENTS AND RESPONSES

| Comment #        | Date             | Comment  | Response  |
|------------------|------------------|--|---|
|                  |                  | forward to much more discussion and debate about these issues.   |   |
| Attachment A03-1 |                  | Map of Alternative C: Infill Focus   | The attachment to the comment letter is acknowledged for the record and will be forwarded to the decision-making bodies as part of the Final EIR for their consideration in reviewing the project.  |
| Attachment A03-2 |                  | Map of Preferred Land Use Alternative  | The attachment to the comment letter is acknowledged for the record and will be forwarded to the decision-making bodies as part of the Final EIR for their consideration in reviewing the project.  |
| Attachment A03-3 |                  | Map of Study Areas and Approved/Pending Projects   | The attachment to the comment letter is acknowledged for the record and will be forwarded to the decision-making bodies as part of the Final EIR for their consideration in reviewing the project.  |
| Attachment A03-4 |                  | Pages 3-26 and 3-27 from Project Description   | The attachment to the comment letter is acknowledged for the record and will be forwarded to the decision-making bodies as part of the Final EIR for their consideration in reviewing the project.  |
| <b>A04</b>       | <b>7/25/2018</b> | <b>California Public Utilities Commission</b>  |   |
| A04-1            |                  | <p>The California Public Utilities Commission (Commission) has jurisdiction over the safety of highway rail crossings (crossings) in California. The California Public Utilities Code requires Commission approval for the construction or alteration of crossings and grants the Commission exclusive power on the design, alteration, and closure of crossings in California.</p> <p>The Commission Rail Crossings Engineering Branch (RCEB) has received the Notice of Availability for the Draft Environment Impact Report (DEIR) from the State Clearinghouse for the proposed City of Stockton (City) Stockton 2040 General Plan Update.</p>   | This comment provides general information about rail crossings and does not address the adequacy of the Draft EIR. The comment is acknowledged and will be forwarded to the decision-making bodies as part of the Final EIR for their consideration in reviewing the project. No further response is required.  |
| A04-2            |                  | According to the DEIR, the project area includes active railroad tracks. RCEB recommends that the City add language to the Stockton 2040 General Plan Update so that any future development adjacent to or near the rail right-of-way (ROW) is planned with the safety of the rail corridor in mind.   | The comment suggests a change to the proposed project and does not address the adequacy of the Draft EIR. Please see Master Response #1, Project Merits, in Section 5.1 of this chapter.  |
| A04-3            |                  | <p>New developments may increase traffic volumes not only on streets and at intersections, but also at at-grade highway-rail crossings. This includes considering pedestrian circulation patterns or destinations with respect to railroad ROW and compliance with the Americans with Disabilities Act. Mitigation measures to consider include the planning for grade separations for major thoroughfares, improvements to existing at-grade crossings due to increase in traffic volumes, and continuous vandal resistant fencing or other appropriate barriers to prevent trespassers onto the railroad ROW.</p> <p>If you have any questions regarding this matter, or any other issues, please feel free to contact me at (916) 928-2515.</p> | <p>Future development projects under the proposed General Plan will be required to comply with all relevant regulations regarding railroad and grade crossing safety, including:</p> <ul style="list-style-type: none"> <li>▪ California Public Utilities Commission regulations regarding grade crossings and grade crossing safety (Public Utilities Code General Provisions, Division 1, Part 1, Chapter 6)</li> <li>▪ Requirements for railroad operators to maintain appropriate fencing along their right-of-way (Public Utilities Code General Provisions, Division 4, Chapter 1, Article 6)</li> </ul> <p>The proposed General Plan does not propose any new locations for at-grade crossings of streets and active railroad tracks. Compliance with these existing regulations will ensure</p> |

**COMMENTS AND RESPONSES**

| Comment #        | Date            | Comment   | Response   |
|------------------|-----------------|---|--|
|                  |                 |   | safety associated with railroad operations in the EIR Study Area. For this reason, the proposed General Plan does not include any new or additional General Plan policies or mitigation measures.  |
| <b>A05</b>       | <b>8/2/2018</b> | <b>Bright Development</b>   |  |
| A05-1            |                 | Hi Dave, we were looking at the new Land Use Map for the General Plan Update and noticed that the Land Use Designation for the property on the West Side of McNair High School was changed to include MDR and HDR Designations from the previous map that showed all LDR. We were wondering what was the catalyst for this change, if we have a choice in the matter, and if you have any backup information that might help us clarify the need to change. At this point we don't know if it is a good thing or bad thing and we haven't taken a position on it but we would like to discuss with you. Can we set up a meeting or phone call? Let me know. | The comment asks questions about the proposed project and does not address the adequacy of the Draft EIR. Please see Master Response #1, Project Merits, in Section 5.1 of this chapter.   |
| Attachment A05-1 |                 | Image of the property on the West Side of McNair High School and surrounding area   | The attachment to the comment letter is acknowledged for the record and will be forwarded to the decision-making bodies as part of the Final EIR for their consideration in reviewing the project.   |
| <b>A06</b>       | <b>8/8/2018</b> | <b>Delta Protection Commission</b>  |  |
| A06-1            |                 | We will be offering comments to express some concern regarding the potential impact on maintaining viability of agriculture in the Primary Zone of the Delta from developing the western edge of the proposed "Economic and Education Enterprise" area. At the EIR workshop I mentioned the interest in suggesting inclusion of the National Heritage Area, but that can be considered independent of the General Plan Update cycle.  | See the responses to Comments A09-3 and A09-4.   |
| A06-2            |                 | Also, there is an apparent discrepancy between the Urban to OS/Ag figure (Fig 3-4) and the proposed GP Land Use Map at Wright-Elmwood Tract along Fourteen-Mile Slough – it appears that the eastern area that was previously "Residential Estate," is re-designated OS/Ag based on a comparison of the existing and proposed Land Use Maps, but it doesn't show up on the Urban to OS/Ag Changes Fig 3-4, at least not from what I can see. Just wanted to confirm that area of Residential Estate has in fact been changed to OS/Ag.  | The comment correctly states that Figure 3-4, Proposed Urban to Open Space Land Use Changes, included in Chapter 3, Project Description, of the Draft EIR should include the parcel of land located along the western boundary of the city directly northeast of the San Joaquin River. As shown in Chapter 3 of this Final EIR, Figure 3-4 and the associated text have been revised accordingly. |
| <b>A07</b>       | <b>8/9/2018</b> | <b>Reinvent South Stockton Coalition</b>  |  |
| A07-1            |                 | Thank you for the opportunity to review the draft Envision Stockton 2040 General Plan. Reinvent South Stockton Coalition's mission is to empower its residents to transform community through improving safety, education, housing, job creation, and health. As a community stakeholder with ongoing initiatives in the city's historically underserved communities, we would like to submit the following comments on the General Plan.   | This comment serves as an opening remark and does not address the adequacy of the Draft EIR. The comment is acknowledged and will be forwarded to the decision-making bodies as part of the Final EIR for their consideration in reviewing the project. No further response is required.   |
| A07-2            |                 | As most Stocktonians can affirm, the story of our community has always been a place of stark contrast and disparate expectations of opportunity.  | This comment provides background information and does not address the adequacy of the Draft EIR. The comment is acknowledged and will be forwarded to the decision-  |

## COMMENTS AND RESPONSES

| Comment # | Date | Comment  | Response   |
|-----------|------|--|--|
|           |      | <p>Simply stated, there exists a part of our community that has been victimized by the echoes of century-old policies of prejudice, deprived of the investment its residents are entitled to as members of our city. As our nation has once again awakened to the subject of equity, so too has Stockton looked at its own past injustices and begun to seek balance. It is in that work that we have seen both interest and resources shift toward those communities that we overlooked and neglected for so long.</p>  | <p>making bodies as part of the Final EIR for their consideration in reviewing the project. No further response is required.</p> |
|           |      | <p>Through the South Stockton Promise Zone effort, a uniquely effective coalition of investors and support structures has developed a plan to achieve transformative goals that were once thought of as implausible for a keystone block within South Stockton. The Airport Corridor, the center of commerce at the corner of 8th Street and Airport Way arguably once represented the culmination of our collective failings as a community to many, but it has now become the focal point of growth for this coalition and the outside investors the plan has attracted.</p>   |  |
|           |      | <p>Members of the Reinvent South Stockton Coalition have invested in the future of this hub of community and enterprise and have leveraged that work to gain the investment necessary to realize their vision to create a thriving nexus for this community. Achieving this goal aligns with the goals of the General Plan to envision and create a healthy community by providing resources, services, opportunity, and the sense of pride and dignity necessary to create a sustainable and healthy community. A brief outline of that work, which has been spearheaded by RSSC's Neighborhood Transformation initiative, is briefly summarized below:</p>               |  |
|           |      | <p><b>- Who serves on the working group?</b><br/>                     Affordable housing developers, public health partners, and other cross-sector Reinvent South Stockton Coalition members and residents interested in revitalizing this neighborhood</p>   |  |
|           |      | <p><b>- What is the group currently working on?</b><br/>                     With the help of City Systems as a consultant, the Neighborhood Transformation working group is developing a South Stockton Promise Zone Community Vision, with a focus on the Airport Way Corridor. The project is a proactive response to decades of disinvestment and neglect in South Stockton. The effort is led by RSSC and its SSPZ partners and has been significantly shaped by community input. The project has surveyed and engaged residents to establish a baseline understanding of community conditions. Partners are also soliciting public and private investment in the</p> |  |



## COMMENTS AND RESPONSES

| Comment # | Date | Comment   | Response  |
|-----------|------|---|---|
|           |      | <p>SSPZ, articulating the needs of residents in the SSPZ, and plan to consult with residents to finalize plan development along Airport Way.</p> <p>- <b>What is the status of the project?</b></p> <ul style="list-style-type: none"> <li>o Status of project: The working group is collaborating with the consultant on fine tuning methodology for assessing community conditions and resident access to commercial services and community amenities.</li> <li>o Project next steps: Preparing and planning for community engagement and input; Collected data will be used to develop optimal scenario for development along Airport Way</li> <li>o Estimated completion: End of 2018</li> </ul>  |   |
| A07-3     |      | <p>Reinvent South Stockton Coalition believes that our work strongly aligns with the General Plan’s Goal CH-2: Restored Communities to “restore disadvantaged communities to help them become more vibrant and cohesive neighborhoods with high-quality affordable housing, a range of employment options, enhanced social and health services, and active public spaces.”</p> <ul style="list-style-type: none"> <li>• Policy CH-2.1: Prioritize maintenance of streets and improvement of sidewalks, parks, and other infrastructure in areas of the city that historically have been comparatively underserved by public facilities.                             <ul style="list-style-type: none"> <li>o RSSC Response: The Promise Zone project on 8th &amp; Airport will help to identify improvements to walkability and accessibility to services for residents in an area of the city that has been underserved. RSSC requests to be included in efforts led by the city to implement this policy.</li> </ul> </li> <li>• Policy CH-2.2: Stimulate investment through partnerships with private property owners, neighborhood groups, health and housing advocates, non-governmental organizations and other community supporters.                             <ul style="list-style-type: none"> <li>o RSSC Response: RSSC partners are proactively connecting with investors within the Stockton community (i.e. Community Medical Centers), foundations, CRA funding, private investors, etc. with the goal of achieving investment in South Stockton. RSSC requests that the city partner with RSSC on an initiative to stimulate investment in historically underserved communities in South Stockton, including efforts to market/recruit developers, as well as planning for Opportunity Zones.</li> </ul> </li> <li>• Policy CH 2.3: Focus on reducing the unique and compounded environmental impacts and risks in disadvantaged communities                             <ul style="list-style-type: none"> <li>o RSSC Response: RSSC partners are working with the City on the Brownfield assessment and prioritizing both the environmental health and population health of the neighborhood in all stages of development. RSSC suggests continued partnership in order to align environmental remediation with efforts to restore the city’s underserved communities.</li> </ul> </li> </ul> | <p>The comment expresses opinions about the proposed project and work that the organization is doing in support of proposed General Plan policies. It does not address the adequacy of the Draft EIR. The comment is acknowledged and will be forwarded to the decision-making bodies as part of the Final EIR for their consideration in reviewing the project. No further response is required.</p> |

## COMMENTS AND RESPONSES

| Comment #  | Date            | Comment   | Response   |
|------------|-----------------|---|--|
| A07-4      |                 | Thank you for the opportunity to comment. As the current Executive Director of Reinvent South Stockton Coalition, I have worked with this group on this project since its inception. I am transitioning out of Stockton into a new role, so if you have questions, please contact my RSSC colleague, Nathan Werth at nwerth@rsscoalition.org or 209-406-0730 for further details and clarification on this project.   | This comment serves as a closing remark and does not address the adequacy of the Draft EIR. The comment is acknowledged and will be forwarded to the decision-making bodies as part of the Final EIR for their consideration in reviewing the project. No further response is required.  |
| <b>A08</b> | <b>8/9/2018</b> | <b>Sierra Club , Delta -Sierra Group Mother Lode Chapter</b>  |  |
| A08-1      |                 | <p>Re: Envision Stockton 2040 DEIR Comments</p> <p>Members of the Delta-Sierra Group Executive Committee spoke on various aspects of the Draft Environmental Impact Report and General Plan documents at the August 2, 2018 Planning Commission Public Hearing including Margo Praus, Paul Plathe, Richard Abood, and Mary Elizabeth. Additionally, Eric Parfrey spoke on behalf of Sierra Club California which coordinates conservation and political actions with the Sierra Club Chapters of which the Mother Lode Chapter which the Delta-Sierra Group belongs is included.</p>  | This comment serves as an opening statement and does not address the adequacy of the Draft EIR. The comment is acknowledged and will be forwarded to the decision-making bodies as part of the Final EIR for their consideration in reviewing the project. No further response is required.  |
| A08-2      |                 | <p>These comments are meant to augment comments received.</p> <p>On a point of order several Planning Commissioners mentioned that they were still reading the General Plan and followed up on a process question with regard to additional public input meetings that are planned to occur after August 10, 2018 that is the end of the 45 day comment period for the Draft Environmental Impact Report and draft General Plan – Envision 2040. Staff stated that 45 days is the minimum comment period but did not offer the Commissions the option which is within their purview to officially extend the comment period.</p> <p>Additionally, the notice of availability states that in addition to the electronic copy that there is a hard copy on file for public review at Cesar Chavez Central Library, 650 N El Dorado St., Stockton CA. On August 4, 2018 review at the Cesar Chavez library occurred and according to Kendra Johnson only the main DEIR was provided by Community Development Department staff. The DEIR paper copy provided did not include the referenced appendices and technical documents that were only available electronically.</p> | <p>This comment provides background information on the public review process for the Draft EIR and does not address the adequacy of the Draft EIR.</p> <p>The 45-day comment period for the Draft EIR closed on August 10, 2018. However, City staff will receive comments on the Draft General Plan all the way through its adoption hearing.</p> <p>The hard copy of the Draft EIR that was made available at the library included a CD in the back of the document that contained all technical appendices (due to the volume of paper required to print those appendices). Computers are available at the library on which to view the contents of the CD.</p> |
| A08-3      |                 | <p><b>1.2.3 MITIGATION MONITORING</b></p> <p>The DEIR early on referenced the requirement for the City of Stockton to adopt a Mitigation Monitoring and Reporting Program intended to ensure the implementation of all mitigation measures adopted through the preparation of an EIR. The DEIR stated that the Mitigation Monitoring and</p>  | The Mitigation Monitoring or Reporting Program is provided in Chapter 6 of this Final EIR.   |

**COMMENTS AND RESPONSES**

| Comment # | Date | Comment  | Response  |
|-----------|------|--|---|
|           |      | Reporting Program for the proposed project will be completed as part of the environmental review process. Please include the Mitigation Monitoring and Reporting Program in the next draft of the EIR which would be near the end of the environmental review process. This is the criteria that will be used to evaluate environmental mitigation measures implementation.  |   |
| A08-4     |      | <p>GHG-2 Implementation of the proposed project would not conflict with an applicable plan, policy, or regulation adopted for the purpose of reducing the emissions of GHGs.</p> <p>The SJCOG RTP/SCS update was adopted June 28, 2018 which is prior to the adoption of Envision Stockton 2040 requiring updated analysis and language compliance in order to qualify for the Delta Plan: Mitigation and Monitoring Reporting Program exemption. A Certification of Consistency resulting from a comparison of the program document with the SJCOG RTP/SCS is required. The current DEIR analysis was based on the 2014 RTP/SCS and so the DEIR will require revision so that the contemporary analysis can be performed.</p> | <p>The analysis in the Draft EIR was based on the environmental setting at the time that the Notice of Preparation was published, which was in 2017. SJCOG is the lead agency responsible for the Regional Transportation Plan/Sustainable Communities Strategy (RTP/SCS). In its June 22, 2017 letter in response to the Notice of Preparation, SJCOG directed the City to show consistency with the 2014 RTP/SCS, which the City did on pages 4.7-43, 4.10-18 to 4.10-20, and 4.14-38 to 4.14-39 of the Draft EIR. SJCOG's August 10, 2018 letter on the Draft EIR did not request that the City update its analysis of consistency with the 2018 RTP/SCS, nor did it indicate that the proposed project is inconsistent with the RTP/SCS.</p>  |
| A08-5     |      | <p><b>4.3 AIR QUALITY</b></p> <p>The DEIR should include more concrete summaries of the implementation of SJVUAPCD Rules. For example, the ETRIP program to implement rule 9410: how many employers in Stockton are required to submit VMT reduction plans and how many have submitted plans?</p>  | <p>The discussion under the heading “Applicable SJVAPCD [San Joaquin Valley Air Pollution Control District] Rules and Regulations” on pages 4.3-10 through 4.3-13 of the Draft EIR provides a summary of the various SJVAPCD rules and regulations that could be applicable to future individual projects accommodated under the proposed General Plan. Further details regarding SJVAPCD rules and regulations and their applicability to and how they would be implemented for future individual projects that would be accommodated under the proposed General Plan can be found on the SJVAPCD Current District Rules and Regulations webpage: <a href="http://www.valleyair.org/rules/1ruleslist.htm">http://www.valleyair.org/rules/1ruleslist.htm</a>. A footnote that provides this link has been added to the rules and regulations discussion on page 4.3-10 of the Draft EIR, as shown in Chapter 3 of this Final EIR.</p> |
| A08-6     |      | <p>Strengthen language for considering actions associated with Policy LU-1.1: Encourage retail businesses in mixed-use developments along regional transportation routes and in areas that serve local residents. Action LU-1.1.A: Requires specific design elements, Action LU-1.1.B: Evaluate the City's parking policies, and amend the Development Code; but Action LU-1.1.C: Continue to study and consider repealing the “Big Box Ordinance” that was adopted in 2007, and if big-box stores are allowed in the future then require applicants to fund an analysis of economic and blight-inducement impacts of the proposed development.</p>  | <p>The comment expresses a general opinion about aspects of the proposed project and does not address the adequacy of the Draft EIR. Please see Master Response #1, Project Merits, in Section 5.1 of this chapter.</p>   |
| A08-7     |      | <p>The DEIR should specifically reference the existing study documents regarding the repealing of the “Big Box Ordinance”.</p>   | <p>The comment requests that the Draft EIR be updated to include a reference to study documents on the "Big Box Ordinance." On August 14, 2007, the Stockton City Council approved Ordinance No. 018-07 C.S., which amends Chapter 16 of the Stockton Municipal Code to limit non-membership warehouse retail stores with 10 percent or more of floor space dedicated to selling nontaxable items to 100,000 square feet or less.</p>   |

## COMMENTS AND RESPONSES

| Comment # | Date | Comment   | Response   |
|-----------|------|---|--|
|           |      |   | <p>As discussed in the August 14, 2007 City Council Agenda Report, economist Phillip King, Ph.D, prepared a report that evaluated the blight-producing impacts of discount superstores on existing grocery stores and neighborhood shopping centers in Stockton. The report concluded that discount superstores would result in the closure of some existing supermarkets and would negatively affect neighborhood shopping centers that are anchored by supermarkets. In addition, the report suggested that the proposed amendment to Chapter 16 of the Stockton Municipal Code (i.e., the "Big Box Ordinance") would help to reduce pressure on key grocery stores in the city, preserve a number of community shopping centers, and help to reduce urban decay in the Downtown.</p> <p>The proposed General Plan includes Action LU-1.1C, which directs the City to continue to study repealing this Big Box Ordinance, and directs that, if big-box stores are allowed in the future, applicants be required to fund an analysis of economic and blight-inducement impacts of the proposed development on retail businesses in the market area, employment, City revenues and services, and any other relevant economic considerations. This action, which is already being studied by the City, was included in the proposed General Plan based on consistent community support from neighborhoods in South Stockton that lack access to grocery stores and other large-scale retail. Residents cited the Big Box Ordinance as the cause for the abandonment of a potential big box store project in the area that would have provided needed retail options. (See relevant workshop input summarized in Attachment D to the 6/8/17 Planning Commission staff report, available here: <a href="http://www.stocktongov.com/clerk/granicusagendas/planning/20170608.pdf">http://www.stocktongov.com/clerk/granicusagendas/planning/20170608.pdf</a>)</p> <p>As identified above, with implementation of Action LU-1.1C, future big-box store applicants would be required to fund an analysis of economic and blight-inducement impacts. Furthermore, the proposed General Plan includes other policies and actions intended to reduce and avoid blight, including by promoting development in the Downtown. See the other policies and actions under Goal LU-1, Regional Destination, which improve the visual quality of the urban environment, address urban design and the public realm, and promote mixed-use redevelopment. The policies and actions under Goal LU-2, Strong Downtown, promote Downtown development and a more vibrant Downtown. Finally, Policy LU-6.2 and its associated actions prioritize development and redevelopment of vacant, underutilized, and blighted infill areas.</p> |
| A08-8     |      | <p>Policy TR 1.1 states "bicycles and pedestrians and vehicles for disabled travelers". Are vehicles the general term for motorized, non-motorized wheelchairs or wheelchair accessible automobiles?</p> <p>Policy TR 2.3 states "wheel" more frequently. Wheel should be changed to bicycle.</p> | <p>The comment suggests policy changes for the proposed project and does not address the adequacy of the Draft EIR. Please see Master Response #1, Project Merits, in Section 5.1 of this chapter.</p>   |

**COMMENTS AND RESPONSES**

| Comment # | Date | Comment  | Response   |
|-----------|------|--|--|
|           |      | Policy SAF-4.2 “Encourage major employers to participate in a transportation demand management program (TDM) that reduces vehicle trips through approaches such as carpooling, vanpooling, shuttles, car-sharing, bike-sharing, end-of-trip facilities like showers and bicycle parking, subscription bus service, transit subsidies, preferential parking, and telecommuting”. The policy does not specify what is the definition of a major employer – if more than 100 employees commuting to a specific location then this is what the SJVUAPCD addresses in Rule 9410.  |  |
| A08-9     |      | Particulate matter associated with accumulated street dust has been reported to constitute as much as 85 percent of ambient airborne particulate matter (PM10) and re-entrainment of street dust is a major source of urban PM2.5 and PM10, which have significant impacts on human health. Appropriate street cleaning methodologies can reduce road dust hazards that negatively impact air quality and storm water runoff quality. Discussions at special meetings to address trash included the suggestion that as a policy the city enacts regular citywide street cleaning with signage to prohibit parking on the sides of streets on particular days. We have several areas of Stockton that do not have regular street cleaning because cars are parked on the sides of streets that are being cleaned. Please include a policy in the final EIR that addresses street cleaning as a means to improve stormwater and air quality. | The City of Stockton currently has a program in place where street sweeping is generally conducted bi-weekly, while major roadways such as Pacific Avenue, El Dorado Street, Center Street, and Hammer Lane are swept weekly and Downtown is swept three times a week. The City has installed signage throughout the city noting the specific street sweeping schedule. Furthermore, the City has a dedicated street sweeping webpage ( <a href="http://www.stocktongov.com/government/departments/publicWorks/garbStSweep.html">http://www.stocktongov.com/government/departments/publicWorks/garbStSweep.html</a> ) that the public can access to find out street sweeping schedules and more information on the City’s street sweeping program. The dedicated webpage also provides information to the public on how to access a hotline to report instances where a street may need further attention. |
| A08-10    |      | Mitigation Measure AQ-2 includes policy to expressing forbidding “use of blowing devices”. Personal and commercial use of blowing devices contribute to poor air quality in our city. Request additional policy consideration for an educational program or incentive to use vacuuming devices to direct and capture materials which are currently been blown somewhere.   | The provisions under Mitigation Measure AQ-2 as they relate to the types of measures to be included in a fugitive dust control plan are recommendations that can be implemented. Because the proposed General Plan is a broad policy level planning document, the specific measures and provisions to consider and include in a fugitive dust control plan for a particular future individual development project will be determined at the time the project comes on line based on the specific circumstances associated with the project. However, per the request of this comment, Mitigation Measure AQ-2 has been updated to include a provision stating that use of electric-powered vacuums should be considered for measures to include in a fugitive dust control plan, as shown in Chapters 2 and 3 of this Final EIR.   |
| A08-11    |      | Mitigation Measure AQ-3 includes “coordination to ensure that bus pad and shelter improvements...” should specify that these facilities do not result in increased idling by vehicles already traveling on the road as a result of a transit stop. Additional lanes pull out with signage will decrease idling of long ques of traffic or dangerous lane changes and increase bicycle safety by reducing transit bicycle conflicts.  | Mitigation Measure AQ-3 has been revised in response to this comment to include the following, “...and that these transit improvements consider and implement design features (e.g., pullout lanes for buses) to avoid or reduce impediment/queuing of vehicles...” as shown in Chapters 2 and 3 of this Final EIR.  |
| A08-12    |      | AQ-5 The DEIR mentioned several times that in the last several years CO hotspots have not been found in the city; however, in the area of Eight Mile   | The comment states that a carbon monoxide (CO) hotspot may be generated in the area of Eight Mile Road (reference not specified). Additionally, the comment states that  |

## COMMENTS AND RESPONSES

| Comment # | Date | Comment   | Response   |
|-----------|------|---|--|
|           |      | <p>Road a CO hotspot may be generated related to focused development in the northern area of the planning area. The DEIR distributed the net total daily vehicle trips throughout the EIR study area instead of focusing on regions where anticipated development is allowed in the 2040 horizon year.</p> <p>“Anticipated development allowed under the proposed General Plan in the 2040 horizon year would result in approximately 2,091,100 average daily trips, which would be an increase of 547,300 total daily vehicle trips over existing conditions. However, distributing the net total daily vehicle trips throughout the EIR Study and region and by peak hour would result in smaller traffic volumes at the various intersections. Thus, implementation of the proposed General Plan and UMPS is not anticipated to produce the volume of traffic required to generate a CO hotspot. Therefore, implementation of the proposed General Plan and UMPS would not have the potential to substantially increase CO hotspots at intersections in the vicinity of the EIR Study Area, and impacts would be less than significant.”</p> <p>The development resulting in increased daily vehicle trips is not distributed uniformly throughout the study area; therefore, additional characterization of air quality impacts where developed is planned is needed.</p> | <p>development is not distributed uniformly throughout the study area, thus additional characterization of air quality impacts where development is planned is needed.</p> <p>As noted in the Draft EIR passage cited in the comment, the proposed General Plan would result in a total daily increase in vehicle trip generation of 547,000 vehicle trips per day in the horizon year. While future development may not be uniform within the city and may be concentrated in some particular areas, distributing the 547,000 daily vehicle trips to the various individual future projects that could come on line, and considering only the peak hour trips, would result in smaller traffic volumes. To illustrate, when daily vehicle trip generation data is not available, a conversion factor of 10 is used to convert peak hour vehicle trips to daily vehicle trips. The conversion factor of 10 is a typical industry standard used by traffic consultants. Applying this conversion factor to the 547,000 daily vehicle trips associated with the proposed General Plan results in a total of 54,700 peak hour trips for the entire EIR Study Area. As indicated on page 4.3-10 of the Draft EIR, a project would have to increase traffic volumes at a single intersection by 24,000 to more than 44,000 vehicles per hour to generate a significant CO impact. Therefore, approximately 44 to 80 percent of the peak hour trips generated by the proposed General Plan would need to occur at a single intersection in order to generate an impact.</p> <p>While future development could be concentrated into certain areas of the city, it is reasonably anticipated that future development under the proposed General Plan would consist of many different individual development projects. More importantly, from an individual project and from a cumulative perspective, it can be reasonably assumed that future vehicle trips would not all occur at a single intersection, but would be distributed over multiple intersections, which would reduce the number of peak hour trips at any one intersection.</p> |
| A08-13    |      | <p>Furthermore, the use of Bay Area air quality screening protocols does not seem appropriate since our weather patterns differ significantly. Use of a SJVAPCD screening recommendations would be more appropriate.</p>  | <p>The analysis in the Draft EIR for the proposed General Plan does not utilize the Bay Area Air Quality Management District (BAAQMD) thresholds. However, the methodology utilized by BAAQMD to demonstrate that CO hotspots are no longer a localized air quality impact of concern are directly applicable to the CO hotspot analysis since modeling conducted by BAAQMD demonstrates that 24,000 to 44,000 peak hour vehicle trips or more are needed to generate a CO hotspot (based on a 2010 fleet mix). The SJVAPCD screening recommendations are based on the Caltrans CO Hotspots Protocol established in 1997, which is outdated. A typical high volume intersection in Stockton does not accommodate the amount of traffic needed to create a CO hotspot using today’s emissions rates, and therefore, BAAQMD findings are cited in the analysis. In addition to this citation, the EIR also demonstrates the CO hotspot analysis is not warranted since the SJVAPCD has not had a CO violation since 1996. As documented in the 1996 Carbon Monoxide Attainment Plan, favorable meteorology did not account</p>   |

## COMMENTS AND RESPONSES

| Comment # | Date | Comment   | Response   |
|-----------|------|---|--|
|           |      |   | <p>solely for the lower CO levels during the 1992-1994 attainment period and the reduction in CO levels is a direct result of the emission reductions resulting from the implementation of a number of California Air Resources Board (CARB) mobile source and clean fuel regulations, as well as stationary source regulations implemented by local districts.<sup>1</sup> Similarly, the South Coast Air Quality Management District (SCAQMD) prepared a CO hotspot analysis as part of its 2003 Air Quality Management Plan to provide support in seeking CO attainment for the South Coast Air Basin (SoCAB). Based on the analysis prepared by SCAQMD, no CO hotspots were predicted for the SoCAB.<sup>2</sup> The analysis included some of Los Angeles’ busiest intersections (i.e., 100,000 or more peak hour vehicle trips operating at LOS E and F).<sup>3</sup></p> <p>To summarize, the CO hotspot analysis under Impact AQ-5 refers to the modeling conducted by BAAQMD because it is based on newer data and considers the improvement in mobile-source CO emissions. Although meteorological conditions in the Bay Area differ from that in inland areas, the modeling conducted by BAAQMD demonstrates that the net increase in peak hour traffic volumes at an intersection in a single hour would need to be substantially higher than the maximum flows at a high volume intersection in Stockton; the SJVAPCD Attainment Plan substantiates that CO hotspots in the San Joaquin Valley Area Basin are not anticipated because of improvements in vehicle emissions rates and stationary source rules that have been adopted since 1996.</p> <p><sup>1</sup> California Air Resources Board. 1996, April. Final Carbon Monoxide Resignation Request and Maintenance Plan for Ten Federal Planning Areas.<br/><a href="https://www.arb.ca.gov/planning/sip/co/co.htm">https://www.arb.ca.gov/planning/sip/co/co.htm</a>.</p> <p><sup>2</sup> South Coast Air Quality Management District, 2003. 2003 Air Quality Management Plan. Appendix V, available at <a href="https://www.aqmd.gov/home/air-quality/clean-air-plans/air-quality-mgt-plan/2003-aqmp">https://www.aqmd.gov/home/air-quality/clean-air-plans/air-quality-mgt-plan/2003-aqmp</a>.</p> <p><sup>3</sup> Intersections analyzed included: Long Beach Boulevard and Imperial Highway; Wilshire Boulevard and Veteran Avenue; Sunset Boulevard and Highland Avenue; and La Cienega Boulevard and Century Boulevard. The busiest intersection evaluated (Wilshire and Veteran) had a daily traffic volume of approximately 100,000 vehicles per day with LOS E in the morning peak hour and LOS F in the evening peak hour.</p> |
| A08-14    |      | Mitigation Measure AQ-5 included reduction of onsite idling to reduce toxic air pollutants. Policy language should be included that commits the City of Stockton to developing in consultation with the SJVUAPCD an anti-idling campaign. | The California Environmental Protection Agency (CalEPA), through its Environmental Justice Task Force, has targeted southern Stockton and is currently coordinating with SJVAPCD on the CalEPA 2018-2019 Environmental Justice Task Force – Stockton Initiative, which will be a focused multi-media environmental compliance and enforcement initiative. <sup>1</sup> As part of the 2013-2014 Fresno Initiative, efforts from SJVAPCD included educating businesses about the State idling-diesel truck regulation. It is reasonably assumed that similar efforts would also be made by SJVAPCD for the planned  |

## COMMENTS AND RESPONSES

| Comment # | Date | Comment   | Response   |
|-----------|------|---|--|
|           |      |   | <p>Stockton Initiative. Furthermore, the proposed General Plan includes Policy SAF-4.3 and Action SAF-4.3A, which call for coordination between the City of Stockton and SJVAPCD in promoting public awareness regarding air quality issues and for the dissemination of SJVAPCD education materials on the City's website. The Stockton Initiative would be an opportunity for coordination between the City of Stockton and SJVAPCD consistent with the proposed policy and action.</p> <p><sup>1</sup> San Joaquin Valley Air Pollution Control District, 2018, August 16. Item Number 13: Receive an Update on the California Environmental Protection Agency's Environmental Justice Task Force – Stockton Initiative, available at <a href="http://www.valleyair.org/Board_meetings/GB/agenda_minutes/Agenda/2018/August/final/13.pdf">http://www.valleyair.org/Board_meetings/GB/agenda_minutes/Agenda/2018/August/final/13.pdf</a>.</p>  |
| A08-15    |      | <p><b>4.4 BIOLOGICAL RESOURCES</b></p> <p>BIO- 1. Since 57 percent of EIR study area is urbanized (41870 acres) several endangered plants and animals could be assisted in their survival by a mitigation measure that would establish development of native plant and animal resources within the community development department that would assist city residents with native plant propagation particularly assisting bee populations that are not covered by the SJMSCP. This mitigation measure would be in addition to those projects that require a landscape plan.</p> | <p>As discussed in Section 4.4, Biological Resources, under Impact Discussion BIO-1 of the Draft EIR, implementation of the proposed General Plan could impact special status plant and animal species within the City of Stockton. However, implementation of the policies and actions that support Goal LU-5, in combination with the San Joaquin County Multi-Species Habitat Conservation and Open Space Plan (SJMSCP) and federal and State laws, would reduce potential impacts to special-status species (both those that are covered by the SJMSCP and those that are not covered by the SJMSCP) to a less-than-significant level, and no further mitigation is required.</p> <p>With respect to the comment's concern regarding native plants and animal resources, the proposed General Plan includes policies and actions that would encourage native plantings. Specifically:</p> <ul style="list-style-type: none"> <li>▪ Action LU-5.1B directs the City to protect, preserve, and improve riparian corridors and incorporate them in the City's parks, trails, and open space system.</li> <li>▪ Action LU-5.1C directs the City to require landscape plans to incorporate native and drought-tolerant plants in order to preserve the visual integrity of the landscape, conserve water, provide habitat conditions suitable for native vegetation, and ensure that a maximum number and variety of well-adapted plants are maintained.</li> </ul> |
| A08-16    |      | <p>Action SAF-2.4.C in the proposed General Plan directs the City to preserve waterways and floodplains for non-urban uses to maintain flood carrying capacity. Additionally, language should be included that commits the City of Stockton to enhance these environments where wildlife migration has been identified as feasible, such as the Calaveras River.</p>  | <p>The comment suggests changes to the proposed project and does not address the adequacy of the Draft EIR. Please see Master Response #1, Project Merits, in Section 5.1 of this chapter.</p>   |
| A08-17    |      | <p>Action LU-5.3.C maintains an agricultural conservation program by which the City will mitigate the loss of agricultural lands, some of which provide habitat to special status species. Is this a current program that will be maintained? If so, then a reference to program planning documents should be included in the DEIR.</p>   | <p>The City's agricultural conservation program was adopted in 2007 under Resolution 07-0080 of the Stockton City Council. As directed by Action LU-5.3C of the proposed General Plan, the City will maintain the agricultural program. The adopting resolution is available to view at the following link: <a href="http://cemerced.ucanr.edu/files/157589.pdf">http://cemerced.ucanr.edu/files/157589.pdf</a>. Agricultural land mitigation fees are reported in the City's annual fee schedule; the most current fee</p>  |



**COMMENTS AND RESPONSES**

| Comment # | Date | Comment   | Response   |
|-----------|------|---|--|
| A08-18    |      | <p>BIO-5 Implementation of the proposed project would not conflict with any local policies or ordinances protecting biological resources. Municipal Code 16.72.245 protects heritage trees. Our trees in general have not been maintained and frequently large limbs snap. A map of these heritage trees and discussion of how well the code is doing to protect these native trees should be included in the DEIR.</p>   | <p>schedule is available at the following link (see page F-83):<br/> <a href="http://www.stocktongov.com/files/2018_19_Adopted_Fee_Schedule.pdf">http://www.stocktongov.com/files/2018_19_Adopted_Fee_Schedule.pdf</a>.<br/>                     Future projects under the proposed General Plan would be required to comply with the Stockton Municipal Code Section 16.72.245, Heritage Trees. As discussed under Impact Discussion BIO-5 in Section 4.4, Biological Resources, of the Draft EIR, any projects proposed under the General Plan that would involve the removal of such a tree would be required to apply for a Heritage Oak Tree Removal Permit, and could only remove such tree after issuance of the permit. Accordingly, the impact was found to be less than significant. Discussing the effectiveness of the existing Code requirements is not pertinent to a consistency analysis, and a map of heritage trees would not affect the analysis or conclusions presented in the Draft EIR.</p> |
| A08-19    |      | <p><b>4.8 HAZARDS AND HAZARDOUS MATERIALS</b><br/>                     HAZ-1 Implementation of the proposed project would not create a significant hazard to the public or the environment through the routine transport, use, or disposal of hazardous materials. Action SAF-2.6.C directs the City to educate the public about household hazardous wastes and the proper methods of disposal, which will minimize risk from the routine use of household hazardous materials. The existing education effort fails to reach a large audience. At some point within the last year batteries and light bulbs were accepted at fire stations now evidently according to the city's website batteries can now go in a clear plastic bag on top of the recycling cans and fluorescent light bulbs have to be driven to the county facility near the airport south of town (Th-Sat 9-3 pm). A City of over 300,000 should have more opportunities available for it's citizens to deal with hazardous wastes and materials.</p> | <p>The comment expresses a general opinion about the effectiveness of the City's current education efforts regarding hazardous materials and about the limitations of the existing hazardous waste collection opportunities. The comment does not address the adequacy of the Draft EIR. Please see Master Response #1, Project Merits, in Section 5.1 of this chapter.</p>  |
| A08-20    |      | <p><b>4.9 HYDROLOGY AND WATER QUALITY</b><br/>                     The DEIR stated:<br/>                     "The CVRWQCB issued a region-wide MS4 Permit (Order No. R5-2016-0040) covering the entire Region, and covering storm drainage systems in cities as small as 10,000 population, in June 2016.3 The City of Stockton and San Joaquin County are permittees on the region-wide Permit. The City of Stockton and San Joaquin County will be updating their Stormwater Management Plan (City) and Stormwater Quality Control Criteria Plan (City and County) pursuant to the region-wide Permit, with completion anticipated in 2018. The City and County will enroll under this permit after completion of those documents." According to Than, Ba, Deputy Director of Collections/Maintenance. Phone conversation with City of Stockton Municipal Utilities Department, August 1, 2017.</p>   | <p>The City's current Stormwater Management Plan is dated April 2009. The City's current Stormwater Quality Control Criteria Plan is dated March 2009. Until updated plans are published, these remain the current plans, and this EIR relies on the information in those current plans.</p>   |
|           |      | <p>The City of Stockton entered into an MOU with San Joaquin to develop the</p>   |  |

## COMMENTS AND RESPONSES

| Comment # | Date | Comment  | Response  |
|-----------|------|--|---|
|           |      | plan and the status of the plan in this DEIR should have been updated within the last year.  |   |
| A08-21    |      | <p><b><i>Surface Water and Groundwater</i></b></p> <p>According to the DEIR the City uses surface water as its primary water supply source, supplementing it with groundwater when insufficient surface water is available to meet water demands. Surface water comprised about two-thirds of City of Stockton Municipal Utility Department (COSMUD) water supplies in 2015, and is forecast to comprise about 75 percent of such supplies in 2040. Surface water is also used extensively for agricultural irrigation in the Stockton region. Groundwater underlying the City of Stockton Planning area is located in the Eastern San Joaquin Groundwater Subbasin which is critically overdrafted.</p> <p>In December 2015 the City of Stockton Council approved the formation of the Groundwater Sustainability Agency (GSA) to encompass all of the City of Stockton for the purpose of developing a groundwater sustainability plan. In June 2017 the Eastern San Joaquin Groundwater Authority Joint Powers Authority held their first meeting. The City of Stockton GSA is one of 17 GSAs in The Eastern San Joaquin Groundwater Authority that are developing a Groundwater Sustainability Plan to address the critically overdrafted status of the Subbasin as well as other water quality and quantity concerns. The Eastern San Joaquin Groundwater Authority as well as the City of Stockton have public outreach requirements. The City of Stockton’s representatives have not been providing City Council or the City’s Water Advisory Group with updates on the status of plan development and meetings are frequently cancelled. The DEIR should include a characterization of the roles and responsibilities of the City of Stockton GSA.</p> | As requested in the comment, a summary of the roles and responsibilities of the City of Stockton Groundwater Sustainability Agency (GSA) has been added to page 4.9-7 of the Draft EIR, as shown in Chapter 3 of this Final EIR.  |
| A08-22    |      | The DEIR stated that the Eastern San Joaquin Subbasin is recharged by water from sources including streams, percolation of rainfall and irrigation water, inflow from other groundwater basins, and intentional recharge at numerous facilities. Intentional recharge is conducted in recharge ponds and on some farm fields with compensation to landowners. A summary of these fluxes as well as a list of recharge ponds and funds paid to landowners should be included in the DEIR.   | The Eastern San Joaquin Groundwater Basin Groundwater Management Plan, which is cited on page 4.9-13 of the Draft EIR as the source for this information, states that, in 1999, the US Congress authorized up to \$25 million for construction of groundwater recharge and conjunctive use projects in Eastern San Joaquin County as part of the Farmington Program Base Project (Farmington Program); “The Farmington Program’s objective is to recharge an average of 35,000 af [acre-feet] of water annually by directly recharging surface water on 800 to 1,200 acres of land in the area described above [the area bounded by Highway 99, Jack Tone Road, the City of Manteca, and the Mokelumne River]. The Farmington Program is a flexible program by which willing landowners with 20 to 100 acre parcels may enter into short-term and long-term agreements and receive market-based compensation for the use of their land for groundwater recharge. In addition all improvements are paid for through the Farmington Program.” |

## COMMENTS AND RESPONSES

| Comment # | Date | Comment  | Response   |
|-----------|------|--|--|
| A08-23    |      | <p>Prior to the formation of the Eastern San Joaquin Groundwater Authority JPA the active a joint powers agency was the Eastern San Joaquin County Groundwater Basin Authority (GBA). The GBA has not met for over a year and the GBA’s main project task which was the development and implementation of the Eastern San Joaquin Integrated Regional Water Management Plan will be overseen by the San Joaquin County Water Advisory Commission.</p>  | <p>The City does not manage the Farmington Program nor pay compensation to landowners, and cannot provide the requested information. Such information would not affect the adequacy of the groundwater recharge analysis in the Draft EIR.</p> <p>This comment provides general information and does not address the adequacy of the Draft EIR. The comment is acknowledged and will be forwarded to the decision-making bodies as part of the Final EIR for their consideration in reviewing the project. No further response is required.</p>  |
| A08-24    |      | <p>Policy SAF-3.2: Protect the availability of clean potable water from groundwater sources. Revise to include from groundwater contamination sources.</p>   | <p>The comment suggests an edit to a policy in the proposed General Plan and does not address the adequacy of the Draft EIR. Please see Master Response #1, Project Merits, in Section 5.1 of this chapter.</p>  |
| A08-25    |      | <p>HYDRO-2.1 Implementation of the proposed project would not substantially deplete groundwater supplies.</p> <p>Groundwater supplies are forecast to increase from about 13,368 afy in 2015 to 29,840 afy in 2040. Available groundwater supplies may not increase if curtailment of pumping is a management tool to address the Eastern San Joaquin Groundwater Subbasin critically overdrafted state.</p> <p>Additionally, Table 4.9-2 included below indicates that significant volumes of surface water will be needed. Should the State of California Water Fix be implemented the surface water sources will have greater quality issues to address. There should be a discussion in the DEIR about the COSMUD extraction of delta water which is contingent on discharge volumes from the City of Stockton Waste Water Treatment Plant (WWTP).</p> | <p>See the responses to Comments A13-50, A13-55 through A13-58, A13-60, and A13-62 and Appendix B to this Final EIR, which demonstrate that the proposed project would not require an increase in groundwater supplies to serve future demand; such demands can be met through surface water sources, even if the City's existing Delta water supply entitlement does not increase (SWRCB Domestic Supply Permit 01-10-15P-001 dated 7/21/15), as anticipated in the City of Stockton 2015 Urban Water Management Plan (UWMP). In addition, the response to Comment A13-57 specifically addresses the California WaterFix project.</p> <p>Projected water supplies from all sources are sufficient for the proposed 2040 General Plan. The City plans to use a fraction of the available groundwater, well below the safe yield as discussed in the 2015 UWMP.</p> |

**COMMENTS AND RESPONSES**

| Comment #  | Date  | Comment  | Response   |                |                           |      |  |      |  |                |                           |                |                           |   |   |        |   |        |   |   |       |   |        |   |       |        |     |        |     |                                   |        |       |     |        |     |        |       |   |       |   |             |      |       |   |        |   |       |        |     |        |     |                             |  |               |             |                |             |
|--|---|--|--|----------------|---------------------------|------|--|------|--|----------------|---------------------------|----------------|---------------------------|---|---|--------|---|--------|---|---|-------|---|--------|---|-------|--------|-----|--------|-----|-----------------------------------|--------|-------|-----|--------|-----|--------|-------|---|-------|---|-------------|------|-------|---|--------|---|-------|--------|-----|--------|-----|-----------------------------|--|---------------|-------------|----------------|-------------|
| <p>TABLE 4.9-2 EXISTING AND FORECAST WATER SUPPLIES BY SOURCE, EIR STUDY AREA</p> <table border="1"> <thead> <tr> <th rowspan="2">Source</th> <th rowspan="2"></th> <th colspan="2">2015</th> <th colspan="2">2040</th> </tr> <tr> <th>Supplies (afy)</th> <th>Percent of Total Supplies</th> <th>Supplies (afy)</th> <th>Percent of Total Supplies</th> </tr> </thead> <tbody> <tr> <td rowspan="3">Purchased water – Calaveras, Stanislaus, and Mokelumne rivers</td> <td>City of Stockton Municipal Utilities Dept. (COSMUD)</td> <td>15,350</td> <td>–</td> <td>24,000</td> <td>–</td> </tr> <tr> <td>California Water Service Company (CWSC)</td> <td>8,787</td> <td>–</td> <td>19,000</td> <td>–</td> </tr> <tr> <td>Total</td> <td>24,137</td> <td>51%</td> <td>43,000</td> <td>35%</td> </tr> <tr> <td rowspan="2">Surface Water (San Joaquin Delta)</td> <td>COSMUD</td> <td>9,428</td> <td>20%</td> <td>50,000</td> <td>41%</td> </tr> <tr> <td>COSMUD</td> <td>6,740</td> <td>–</td> <td>6,740</td> <td>–</td> </tr> <tr> <td rowspan="2">Groundwater</td> <td>CWSC</td> <td>6,628</td> <td>–</td> <td>23,100</td> <td>–</td> </tr> <tr> <td>Total</td> <td>13,368</td> <td>28%</td> <td>29,840</td> <td>24%</td> </tr> <tr> <td colspan="2"><b>Total Water Supplies</b></td> <td><b>46,993</b></td> <td><b>100%</b></td> <td><b>122,840</b></td> <td><b>100%</b></td> </tr> </tbody> </table> <p>Note: afy = acre-feet per year<br/>                 Sources: California Water Service Company (CWSC) Stockton District, 2016, 2015 Urban Water Management Plan; City of Stockton, 2016, 2015 Urban Water Management Plan.</p> |   |  |  | Source         |                           | 2015 |  | 2040 |  | Supplies (afy) | Percent of Total Supplies | Supplies (afy) | Percent of Total Supplies | Purchased water – Calaveras, Stanislaus, and Mokelumne rivers | City of Stockton Municipal Utilities Dept. (COSMUD) | 15,350 | – | 24,000 | – | California Water Service Company (CWSC) | 8,787 | – | 19,000 | – | Total | 24,137 | 51% | 43,000 | 35% | Surface Water (San Joaquin Delta) | COSMUD | 9,428 | 20% | 50,000 | 41% | COSMUD | 6,740 | – | 6,740 | – | Groundwater | CWSC | 6,628 | – | 23,100 | – | Total | 13,368 | 28% | 29,840 | 24% | <b>Total Water Supplies</b> |  | <b>46,993</b> | <b>100%</b> | <b>122,840</b> | <b>100%</b> |
| Source   |   | 2015   |  |                |                           | 2040 |  |      |  |                |                           |                |                           |   |   |        |   |        |   |   |       |   |        |   |       |        |     |        |     |                                   |        |       |     |        |     |        |       |   |       |   |             |      |       |   |        |   |       |        |     |        |     |                             |  |               |             |                |             |
|  |   | Supplies (afy)   | Percent of Total Supplies  | Supplies (afy) | Percent of Total Supplies |      |  |      |  |                |                           |                |                           |   |   |        |   |        |   |   |       |   |        |   |       |        |     |        |     |                                   |        |       |     |        |     |        |       |   |       |   |             |      |       |   |        |   |       |        |     |        |     |                             |  |               |             |                |             |
| Purchased water – Calaveras, Stanislaus, and Mokelumne rivers  | City of Stockton Municipal Utilities Dept. (COSMUD) | 15,350   | –  | 24,000         | –                         |      |  |      |  |                |                           |                |                           |   |   |        |   |        |   |   |       |   |        |   |       |        |     |        |     |                                   |        |       |     |        |     |        |       |   |       |   |             |      |       |   |        |   |       |        |     |        |     |                             |  |               |             |                |             |
|  | California Water Service Company (CWSC)             | 8,787  | –  | 19,000         | –                         |      |  |      |  |                |                           |                |                           |   |   |        |   |        |   |   |       |   |        |   |       |        |     |        |     |                                   |        |       |     |        |     |        |       |   |       |   |             |      |       |   |        |   |       |        |     |        |     |                             |  |               |             |                |             |
|  | Total   | 24,137   | 51%  | 43,000         | 35%                       |      |  |      |  |                |                           |                |                           |   |   |        |   |        |   |   |       |   |        |   |       |        |     |        |     |                                   |        |       |     |        |     |        |       |   |       |   |             |      |       |   |        |   |       |        |     |        |     |                             |  |               |             |                |             |
| Surface Water (San Joaquin Delta)  | COSMUD  | 9,428  | 20%  | 50,000         | 41%                       |      |  |      |  |                |                           |                |                           |   |   |        |   |        |   |   |       |   |        |   |       |        |     |        |     |                                   |        |       |     |        |     |        |       |   |       |   |             |      |       |   |        |   |       |        |     |        |     |                             |  |               |             |                |             |
|  | COSMUD  | 6,740  | –  | 6,740          | –                         |      |  |      |  |                |                           |                |                           |   |   |        |   |        |   |   |       |   |        |   |       |        |     |        |     |                                   |        |       |     |        |     |        |       |   |       |   |             |      |       |   |        |   |       |        |     |        |     |                             |  |               |             |                |             |
| Groundwater  | CWSC  | 6,628  | –  | 23,100         | –                         |      |  |      |  |                |                           |                |                           |   |   |        |   |        |   |   |       |   |        |   |       |        |     |        |     |                                   |        |       |     |        |     |        |       |   |       |   |             |      |       |   |        |   |       |        |     |        |     |                             |  |               |             |                |             |
|  | Total   | 13,368   | 28%  | 29,840         | 24%                       |      |  |      |  |                |                           |                |                           |   |   |        |   |        |   |   |       |   |        |   |       |        |     |        |     |                                   |        |       |     |        |     |        |       |   |       |   |             |      |       |   |        |   |       |        |     |        |     |                             |  |               |             |                |             |
| <b>Total Water Supplies</b>  |   | <b>46,993</b>  | <b>100%</b>  | <b>122,840</b> | <b>100%</b>               |      |  |      |  |                |                           |                |                           |   |   |        |   |        |   |   |       |   |        |   |       |        |     |        |     |                                   |        |       |     |        |     |        |       |   |       |   |             |      |       |   |        |   |       |        |     |        |     |                             |  |               |             |                |             |
| A08-26   |   | <p>HYDRO-2.2 Implementation of the proposed project would not substantially interfere with groundwater recharge. The DEIR groundwater recharge impacts would be less than significant after implementation of BMPs required by the City of Stockton. Areas within the planning sphere that have a high potential for recharge<sup>1</sup> and the results of existing recharge projects undertaken by the City of Stockton should be analyzed particularly as recharge ponds have been identified as a means to reduce delta brackish water intrusion due to reduced groundwater levels. Additional analysis of this impact is needed in the DEIR.</p> | <p>Developed urban lands are not typically used for recharge ponds. In response to this comment, a map showing soil suitability for groundwater recharge has been added to Section 4.9, Hydrology and Water Quality, and considered in the analysis under Impact Hydro-2.2, as shown in Chapter 3 of this Final EIR.</p>                                   |                |                           |      |  |      |  |                |                           |                |                           |   |   |        |   |        |   |   |       |   |        |   |       |        |     |        |     |                                   |        |       |     |        |     |        |       |   |       |   |             |      |       |   |        |   |       |        |     |        |     |                             |  |               |             |                |             |
| A08-27   |   | <p>Mitigation Measure HYDRO-5: Complete a citywide storm drainage master plan, including hydrologic and hydraulic models for existing land use conditions and for the land uses anticipated in 2040 under the proposed General Plan. A time frame for this mitigation measure is essential</p>   | <p>Implementing Mitigation Measure HYDRO-5 involves several steps, such as identifying areas that have constraints, prioritizing watersheds to be modeled, and evaluating the City stormwater fee program for potential revisions. This effort will be part of a future work plan to be developed following adoption of the proposed General Plan. New</p> |                |                           |      |  |      |  |                |                           |                |                           |   |   |        |   |        |   |   |       |   |        |   |       |        |     |        |     |                                   |        |       |     |        |     |        |       |   |       |   |             |      |       |   |        |   |       |        |     |        |     |                             |  |               |             |                |             |

<sup>1</sup> <https://casoilresource.lawr.ucdavis.edu/sagbi/>

**COMMENTS AND RESPONSES**

| Comment # | Date | Comment  | Response  |
|-----------|------|--|---|
|           |      | particularly since there is already localized flooding resulting from gutter obstructions and under-sized facilities.  | development will be required to complete stormwater plans to identify and construct required infrastructure improvements to address drainage, flood control, and storm water quality. As shown in Chapter 2 of this Final EIR, the mitigation measure has been revised to add specificity regarding implementation steps and timing.  |
| A08-28    |      | HYDRO-6 Implementation of the proposed project would not otherwise substantially degrade water quality. A description of the City of Stockton’s 2017 stormwater quality should be included in the DEIR because no substantive changes are being proposed and if stormwater quality criteria are exceeded additional measures will be necessary and should be included as mitigation in the DEIR.   | <p>As requested in the comment, a description of the City’s 2016-2017 stormwater quality has been added to page 4.9-12 of the Draft EIR, as shown in Chapter 3 of this Final EIR.</p> <p>This information does not change the findings in the Draft EIR pertaining to stormwater quality, and additional mitigation measures are not required, based on the following:</p> <ul style="list-style-type: none"> <li>▪ In November 2016, the City of Stockton and San Joaquin County submitted Notices of Intent (NOIs) to obtain coverage under the General Permit for Discharges from Municipal Separate Storm Sewer Systems (MS4), Order R5-2016-0040 (General Permit). After review of the NOIs, the Central Valley Regional Water Quality Control Board (Central Valley Board) has determined that the City and County qualify for coverage under the General Permit. Thus, the City’s stormwater program is guided by the State’s General Permit, and not by the City’s General Plan.</li> <li>▪ Additional growth in the City will occur regardless of whether the City adopts the proposed General Plan or continues to utilize the 2035 General Plan. The State’s General Permit will continue to guide the City’s stormwater program requirements regardless of whether the proposed General Plan is adopted by the City.</li> <li>▪ The City is currently actively managing its stormwater and working to improve the quality of its stormwater runoff and receiving waters, and will continue to do so regardless of whether or not the proposed General Plan is adopted by the City.</li> </ul> |
| A08-29    |      | HYDRO-7 Implementation of the proposed project would place housing within a 100-year flood hazard area as mapped on a federal Flood Hazard Boundary or Flood Insurance Rate Map or other flood hazard delineation map. The proposed General Plan would designate approximately 155 acres of vacant land in the 100-year flood zone for residential use, and would re-designate approximately 173 acres of land from other land uses to residential within the 100-year flood zone. According to the DEIR approximately 2,000 residential units could be constructed within the 100-year flood zone. Mitigation by property owners and the City of Stockton to aid in funding of levees to certify compliance with SB5 creates bad policy. Those acres should be set aside for nature area or facilities that can accommodate flood waters not homes. | <p>As explained on page 4.9-30 of the Draft EIR, homeowners within the 100-year flood zone would be required to comply with flood insurance requirements under the National Flood Insurance Program. In addition, per Section 15.44.150 of the Stockton Municipal Code, new residential development, or existing structures necessitating significant improvements, located within the 100-year flood zone are required to be elevated at least 2 feet above the 100-year flood level. Development would only be permitted in areas where the City of Stockton could provide substantial evidence showing that flood depths in a 200-year flood would not exceed 3 feet, per SB 5 (Chapter 364, Statutes of 2007) and proposed General Plan Action SAF-2.4.A. Other proposed General Plan policies and actions, as summarized in the Draft EIR, would further address flood hazards. The impact was found to be less than significant, and no mitigation is required.</p> <p>In addition, proposed General Plan Action SAF-2.4C directs the City to preserve floodways and floodplains for non-urban uses to maintain existing flood-carrying capacities.</p>   |

## COMMENTS AND RESPONSES

| Comment # | Date | Comment   | Response   |
|-----------|------|---|--|
| A08-30    |      | <p><b>4.10 LAND USE AND PLANNING</b><br/>                     1500 acres of parks in 62240 acres within the DEIR study area is inadequate. The parks list should have totals for each planning area or neighborhood so that the equity of distribution could be assessed.</p>   | <p>The comment expresses a general opinion about the proposed project and does not address the adequacy of the Draft EIR. The distribution of parks is demonstrated in Figure 4.13-3 on page 4.13-20 of the Draft EIR. Please see Master Response #1, Project Merits, in Section 5.1 of this chapter.</p>  |
| A08-31    |      | <p><b>4.11 NOISE</b><br/>                     NOISE-1 The proposed project would not expose people to or generate noise levels in excess of standards established in the General Plan or the Municipal Code, and/or the applicable standards of other agencies. The DEIR TABLE 4.11-8 EXISTING ROADWAY NOISE ANALYSIS did not analyze distances when 75 decibels were exceeded, yet in TABLE 4.11-10 LAND USE COMPATIBILITY FOR COMMUNITY NOISE ENVIRONMENTS Infill is allowed 80 db, the same as a mining operation, and the same as included in the 2035 General Plan. We can do better. The data included in the DEIR do not support allowing for noise degradation to that level for infill. Table 4.11-10 should be updated to decrease the noise allowance for infill to be something more reasonable for what will be expected in infill areas. The long-term noise monitoring station noted Figure 4.11-2 located near I-5 and Hwy 4 exceeded 100 decibels in 1 hour within 24 hours.</p> | <p>Urban residential infill development in noise environments of 71 to 80 dBA Ldn would be considered "Conditionally Acceptable," and would only be allowed after a detailed analysis of the noise reduction requirements is made and needed insulation features have been included in the design. Because urban residential infill projects in noise environments above 70 dBA Ldn (Table 4.11-8 provides screening distances for these areas) would be required, it is not necessary to include screening distances for noise environments above 75 dBA Ldn. Also, to clarify, noise levels of above 100 dBA Lmax (instantaneous maximum noise level) were measured at LT-1, as opposed to hourly Leq.</p>   |
| A08-32    |      | <p><b>4.12 POPULATION AND HOUSING</b><br/>                     The DEIR included two projections the 2040 horizon-year projection for the proposed General Plan includes the following:<br/>                     40,900 new dwelling units<br/>                     132,200 new residents<br/>                     63,300 new jobs<br/>                     13.8 million square feet of new commercial space and office space<br/>                     35.6 million square feet of new industrial space</p> <p>By comparison, SJCOG projects the following between 2015 and 2040:<br/>                     48,270 new dwelling units<br/>                     153,530 new residents<br/>                     41,030 new jobs</p> <p>These are very different and a clear rationale for selecting one estimate over another was not included in the DEIR.</p>  | <p>On pages 4.12-5 through 4.12-7, the Draft EIR considered whether the proposed General Plan would induce substantial population growth by comparing the 2040 development projections to those of SJCOG. As indicated in the comment, residential development under the proposed General Plan would fall within SJCOG's projection, while employment growth under the proposed General Plan would exceed SJCOG's projection, resulting in a significant impact.</p> <p>The methodology for estimating the 2040 development projections under the proposed General Plan considered SJCOG's projections, as well as those of other agencies, as summarized on pages 3-24 to 3-28 of the Draft EIR and in Master Response #2, Development Projections, in Section 5.1 of this chapter.</p> |
| A08-33    |      | <p>Review of previous housing reports indicated that there is a greater need in Stockton to house single mothers with children, the disabled, and the elderly. The ratio in some areas for multifamily homes is low to non-existent.</p>  | <p>This comment provides general information and does not specifically address the adequacy of the Draft EIR. The comment is acknowledged and will be forwarded to the decision-making bodies as part of the Final EIR for their consideration in reviewing the project. No further response is required.</p>  |

**COMMENTS AND RESPONSES**

| Comment # | Date | Comment   | Response  |
|-----------|------|---|---|
| A08-34    |      | <b>4.13 PUBLIC SERVICES AND RECREATION</b><br>City of Stockton Police services include Code Enforcement and Animal Services both of which provide valuable services to the community at large.  | This comment provides general information about the City of Stockton police services and does not address the adequacy of the Draft EIR. The comment is acknowledged and will be forwarded to the decision-making bodies as part of the Final EIR for their consideration in reviewing the project. No further response is required.  |
| A08-35    |      | The DEIR stated that the response time for priority one calls are greater than 5 minutes in the northern area of Stockton. According to changes in the North/South development additional mitigation is needed to pay for Police and Fire facilities located in areas outside of the core area.                   | Impacts PS-1 and PS-2 in Section 4.13, Public Services and Recreation, of the Draft EIR include an analysis of potential environmental impacts regarding the need for new or physically altered fire and police protection facilities, the construction of which could cause significant environmental impacts in order to maintain acceptable service ratios, response times, or other performance objectives. These analyses determined that impacts would be less than significant. As discussed in Chapter 4.13, new development allowed under the proposed project would require additional staffing and equipment, which could require new facilities to house them. The estimated timing or location of such facilities, if required, or the exact nature of these facilities are not known, so project-specific environmental impacts that would occur from their construction and operation cannot be determined. However, such impacts would be project-specific, and would require permitting and review in accordance with CEQA, which would ensure that any environmental impacts are disclosed and mitigated to the extent possible. For those reasons, as well as proposed General Plan actions that would minimize the environmental impacts of new or expanded facilities, the Draft EIR found that the impacts would be less than significant.<br><br>The cost of providing police and fire protection services is not related to an impact under CEQA. |
| A08-36    |      | Parks and recreational facilities and programs are lacking in Stockton with 1500 acres for over 300,000 residents within the city limits. Park acreage by planning area, neighborhood, census district or zip code is needed to evaluate equity issues related to the distribution and maintenance of facilities. | See the response to Comment A08-30. The comment does not address the adequacy of the Draft EIR. The comment is acknowledged and will be forwarded to the decision-making bodies as part of the Final EIR for their consideration in reviewing the project. No further response is required.   |
| A08-37    |      | The Infill in the Central area will require additional funding sources since those projects will be of a smaller acreage size and not trigger the mitigation fee. The DEIR should include an analysis of infill projects and recreational facilities available to residents and visitors to the downtown core     | Impacts PS-3 and PS-5 in Section 4.13, Public Services and Recreation, of the Draft EIR evaluate potential impacts regarding the need for new or physically altered park and recreational facilities, the construction of which could cause significant environmental impacts. These analyses found that impacts would be less than significant. The estimated timing, location, or exact nature of new park or recreation facilities, if required, are not known, so project-specific environmental impacts that would occur from their construction and operation cannot be determined at this time. However, such impacts would be project-specific, and would require permitting and review in accordance with CEQA, which would ensure that any environmental impacts are disclosed and mitigated to the extent possible. For these reasons, as well as proposed General Plan actions that would minimize the environmental impacts of new or expanded facilities, the Draft EIR found that impacts would be less than significant.  |

## COMMENTS AND RESPONSES

| Comment #  | Date             | Comment   | Response  |
|------------|------------------|---|---|
|            |                  |   | <p>In addition, Impact PS-4 in Section 4.13 of the Draft EIR, considers whether the proposed project would increase the use of existing parks and recreational facilities such that substantial physical deterioration would occur or be accelerated. The impact was also found to be less than significant based on proposed General Plan policies and actions that support parkland goals, coupled with Municipal Code requirements regarding parkland dedication and/or fee requirements, helping to ensure that parks and recreation facilities are not overburdened by use. The Draft EIR also cites other proposed General Plan actions that protect the public's investment in park and recreation facilities.</p> <p>The analyses summarized above apply to all areas of Stockton, including Downtown infill development. Furthermore, as indicated on pages 11 and 12 of the Existing Conditions Technical Memorandum: Market Analysis, prepared as part of the proposed General Plan Update process and available on the City's website (<a href="http://www.stocktongov.com/files/GP_UpdateMarketAnalysis.pdf">http://www.stocktongov.com/files/GP_UpdateMarketAnalysis.pdf</a>), the population residing in the Greater Downtown area contracted by about 8 percent between 2000 and 2010, and more recent data indicates that this trend has continued in recent years. Therefore, park and recreation facilities that already exist in the Downtown are likely adequate to meet the demands of future small-scale infill development.</p> |
| <b>A09</b> | <b>8/10/2018</b> | <b>Delta Protection Commission</b>  |   |
| A09-1      |                  | Thank you for providing the Delta Protection Commission (Commission) the opportunity to review the Envision Stockton 2040 General Plan Update and Draft Environmental Impact Report (Project, or DEIR).   | This comment serves as an introductory statement and does not address the adequacy of the Draft EIR. The comment is acknowledged and will be forwarded to the decision-making bodies as part of the Final EIR for their consideration in reviewing the project. No further response is required.  |
| A09-2      |                  | Proposed projects within the Primary Zone of the Legal Delta must be consistent with the Commission's Land Use and Resource Management Plan (LURMP). Pursuant to PRC Section 29770(d), the Commission may provide comments on proposed projects in the Secondary Zone that have the potential to affect the resources of the Primary Zone. Portions of the City of Stockton are located within the Secondary Zone of the Legal Delta. Therefore, as a general comment, we recommend that the Land Use and Planning section of the EIR (Chapter 4.10), Environmental Setting, Regulatory Framework (section 4.10.1.1) listing of Regional Regulations include the Delta Protection Commission Land Use and Resource Management Plan. | The comment correctly states that the portions of the City of Stockton are located within the Secondary Zone of the Legal Delta. As shown in Chapter 3 of this Final EIR, Chapter 4.10 of the Draft EIR was revised to include a description of the Delta Protection Commission Land Use and Resource Management Plan.  |
| A09-3      |                  | After careful review, more specifically we find that the Project as proposed raises some concerns relative to the new "Economic and Education Enterprise" designation north of West Eight Mile Road and west of Interstate 5. Future development at the western end of the proposed area, if not carefully planned, could adversely impact the viability of the adjacent agricultural lands to the west, within the Primary Zone. The designation   | Overall, when compared to the existing 2035 General Plan, the proposed 2040 General Plan would preserve significantly more farmland by changing approximately 9,000 acres at the edge of the city from an urban designation to Open Space/Agriculture. Please see page 3-17 and Figure 3-4 (as revised in Chapter 3 of this Final EIR) for additional information about these changes. The area designated Economic and Education Enterprise in the proposed General Plan is already designated for urban uses under the  |



**COMMENTS AND RESPONSES**

| Comment # | Date | Comment  | Response   |
|-----------|------|--|--|
|           |      | <p>would affect two parcels in this area that are in active Williamson Act contracts.</p> <p>These impacts are captured in the EIR Impacts AG-1 and AG-2:</p> <p>Impact AG-1: Implementation of the proposed project would convert farmlands of concern under CEQA to non-agricultural use.</p> <p>Impact AG-2: Implementation of the proposed project would conflict with an existing Williamson Act contract.</p> <p>The DEIR concludes (pp 4.2-12 and 4.2-14):</p> <p>Because these farmland areas are located near existing urbanized areas, they may not be viable for agricultural operations due to conflicts with nearby urbanized areas. The only way to mitigate this impact would be to prohibit any development on farmland of concern.</p> <p>The DEIR finds both Impacts AG-1 and AG-2 to be significant and unavoidable. We believe this oversimplifies a complex issue, and creates a false, "all-or-nothing" dichotomy that can lead to increasing conversion of farmland areas that are "near existing urbanized areas" by assuming they will become non-viable. Commission staff suggest this General Plan Update provides an opportunity to take a more balanced approach. To optimally preserve the viability of the agricultural lands in the Primary Zone, the area north of West Eight Mile Road and within vicinity of the Primary Zone boundary should be designated Open Space/Agriculture.</p> | <p>Village designation in the 2035 General Plan.</p> <p>Designation of land for not agricultural purposes does not necessarily mean that the Williamson Act Contract would be affected. Generally, land is continued to be farmed until pre-zoned and annexed to the City. Further, the Williamson Act Contract process takes 10 years to retire unless significant monetary penalties are paid.</p> <p>Inclusion of a mitigation measure that would change the land use designations would inherently change the proposed project and would be considered an alternative to the proposed project. The EIR considered an alternative - the Infill Focus Alternative - in Chapter 5 of the Draft EIR that would implement the suggestion in the comment to designate the Economic and Education Enterprise area for Open Space/Agriculture instead, and concluded that it is the Environmentally Superior Alternative, in part because it would reduce the impacts on agricultural resources. Please also see Master Response #3, Mitigation, in Section 5.1 of this chapter.</p> <p>In addition, as shown in Chapters 2 and 3 of this Final EIR, a mitigation measure has been added for Impact AG-1. The mitigation measure requires that development projects that would convert farmlands of concern under CEQA to a non-agricultural use must participate in the City's existing agricultural conservation program, which requires either dedication of an agricultural conservation easement at a 1:1 ratio or payment of an in-lieu agricultural mitigation fee.</p> |
| A09-4     |      | <p>However, the Commission also has a mission to protect, maintain, enhance and enrich the quality of the Delta environment and economy. Should the City determine that, on balance, designation of the area north of West Eight Mile Road as Economic and Education Enterprise is essential to its economic needs, the principles of the following LURMP policies, or the policies themselves, should be incorporated into the General Plan and DEIR analysis:</p> <p>Land Use P-3: New non-agriculturally oriented residential, recreational, commercial, habitat, restoration, or industrial development shall ensure that appropriate buffer areas are provided by those proposing new development to prevent conflicts between any proposed use and existing adjacent agricultural parcels. Buffers shall adequately protect integrity of land for existing and future agricultural uses and shall not include uses that conflict</p>   | <p>Responses to each of the policy suggestions from the Delta Protection Commission's Land Use and Resource Management Plan (LURMP) are provided below:</p> <ul style="list-style-type: none"> <li>▪ <b>Land Use P-3:</b> Buffers, often in the form of undeveloped land separating agricultural uses and urban development, are often suggested in an attempt to ensure that the agricultural use can continue. The concern is that the continuation of the agricultural use can be threatened if it is forced to change operation due to the new development or is considered a nuisance by new residents due to odor, noise, dust, fertilizer, pesticides, etc., associated with normal farming practices. Recognizing the importance of agriculture, the City has adopted codes to protect existing agriculture from new development.</li> </ul> <p>The determination that farming activity is a nuisance is precluded in the city by Section 16.36.040 of the Municipal Code that establishes a right to farm. As a result, new residents cannot use the City's laws to initiate zoning enforcement proceedings.</p>  |

## COMMENTS AND RESPONSES

| Comment # | Date | Comment  | Response   |
|-----------|------|--|--|
|           |      | <p>with agricultural operations on adjacent agricultural lands. Appropriate buffer setbacks shall be determined in consultation with local Agricultural Commissioners, and shall be based on applicable general plan policies and criteria included in Right-to-Farm Ordinances adopted by local jurisdictions.</p> <p>Land Use P-7: New structures shall be set back from levees and areas that may be needed for future levee expansion consistent with local reclamation district regulations and, upon adoption, with the requirements to be identified in the California Department of Water Resources Central Valley Flood Control Plan.</p> <p>Agriculture P-2: Conversion of land to non-agriculturally-oriented uses should occur first where productivity and agricultural values are lowest.</p> <p>Agriculture P-4: Support agricultural programs that maintain economic viability and increase agricultural income in accordance with market demands, including but not limited to wildlife-friendly farming, conservation tillage and non-tillage.</p> <p>Agriculture P-5: Local governments shall encourage implementation of the necessary plans and ordinances to: maximize agricultural parcel size; reduce subdivision of agricultural lands; protect agriculture and related activities; protect agricultural land from conversion to non-agriculturally-oriented uses. An optimum package of regulatory and incentive programs could include: (1) an urban limit line; (2) minimum parcel size consistent with local agricultural practices and needs; (3) strict subdivision regulations regarding subdivision of agricultural lands to ensure that subdivided lands will continue to contain agriculturally-oriented land uses; (4) require adequate buffers between agricultural and non-agricultural land uses particularly residential development outside but adjacent to the Primary Zone; (5) an agriculture element of the general plan; (6) a Right-to-Farm ordinance; and (7) a conservation easement program.</p> <p>Agriculture P-9: Support agricultural tourism and value-added agricultural production as a means of maintaining the agricultural economy of the Delta.</p> | <p>The use of fertilizers and pesticides is regulated by the State, and the landowner must contain the product(s) on the land. Agricultural chemical overspray can harm adjacent crops as well as pose a health risk to residents. There are federal and State regulations that require chemical applicators to reduce the potential for overspray, and applicators are required to take weather conditions into account before application. Reduction of overspray is also important to the applicator as inappropriately used fertilizers and pesticides increase the cost of farming. Because some farms use no chemicals or fertilizers, while others may use several, it is too speculative to establish a single buffer size that would address all potential use. Therefore, the proposed General Plan relies on enforcement of federal and State laws regulating the use of these materials.</p> <p>Vegetative buffers that reduce the potential for overspray include trees or shrubs at the edge of fields, and grass or natural areas along the edges. These features would be part of any landscaping requirement for the Economic and Education Enterprise designation. Unfarmed areas exist along agricultural lands with different ownership as a practical matter because access is required to the land during farming and the edges of the land provide access. Further, California Water Quality Control Board requirements regulate runoff from all land uses, including farming.</p> <p>Another issue related to urban development adjacent to active farmland is the theft of ripe crops by residents of the adjacent land through unauthorized harvesting. This is best managed by a physical barrier such as walls or fences, education, and the enforcement of trespass laws. Section 16.48.080 requires a wall between residential and non-residential land uses. A solid wall would preclude casual access to the adjacent farmland. Enforcement of laws is already a priority of the City.</p> <p>From a land use perspective, the creation of buffers without design context can create difficulties in terms of access and maintenance. If considered open space, buffers encourage public access, which is counter to their purpose of separating people from the farming activity. If not maintained properly, buffers can become a safety hazard due to unkempt vegetation, and can harbor pests that could affect the adjacent farm. To avoid this potential, it is best if any buffer is incorporated into the landscape design of a project. In this instance, development in the Economic and Education Enterprise area would require design review and project-level CEQA compliance before any development can occur.</p> <p>As noted above, the environmental impacts associated with urban land uses adjacent to agricultural land are adequately addressed through existing laws and the City's development process. The wording suggested in this comment under LURMP Policy Land Use P-3 does not address an environmental issue, but rather suggests a policy change by the City.</p> |
|           |      |  | <ul style="list-style-type: none"> <li>▪ <b>Land Use P-7:</b> Section 16.36.110(A)(3) of the City's Development Code already</li> </ul>  |

**COMMENTS AND RESPONSES**

| Comment # | Date      | Comment  | Response  |
|-----------|-----------|--|---|
| A10       | 8/10/2018 | Delta Stewardship Council  | <p>requires a minimum 15-foot setback from a flood control levee, with additional requirements for larger development projects that are adjacent to levees that provide 200-year level flood protection. In addition, Action SAF-2.3C in the proposed General Plan directs the City to require new waterfront development to provide setbacks and easements along levees to provide space for levee widening, flood fighting, roadway and maintenance access, and other amenities. Therefore, existing City regulations and the proposed General Plan already incorporate the principles of this LURMP policy.</p> <ul style="list-style-type: none"> <li>▪ <b>Agriculture P-2:</b> This policy would not reduce the severity of the proposed project's impacts on agricultural resources. The identified impacts would result from the potential conversion of farmlands of concern under CEQA to urban uses and from the application of urban designations on land that is under active Williamson Act contracts. Prioritizing development based on agricultural productivity would have no effect on the severity of those impacts.</li> <li>▪ <b>Agriculture P-4:</b> This policy would support the agricultural industry, but it would not reduce the severity of the identified impacts on agricultural resources, as explained for LURMP Policy Agriculture P-2 above. Furthermore, the proposed General Plan includes policies and actions that support the local agriculture industry, including Policy CH-1.3 and its associated actions that would facilitate farmers' markets and community gardens and establish Code standards for urban agriculture. The City also supports the economic viability of the agriculture industry through its Right to Farm Ordinance (Section 16.36.040 of the City's Development Code).</li> <li>▪ <b>Agriculture P-5:</b> The land use map in the proposed General Plan achieves many of the objectives in this policy (i.e., protecting agriculture from conversion and limiting urbanization) by changing approximately 9,000 acres from an urban designation to Open Space/Agriculture. The proposed General Plan would not have authority over subdivision and parcel sizes in agricultural areas as the lands are outside the jurisdiction of the City. As described in the responses to Comments A08-17, A13-23, and A13-26, the City manages an existing agricultural conservation program in which agricultural land conversion is mitigated through agricultural conservation easements. See the discussion of LURMP Policy Land Use P-3 above regarding buffers, and see the discussion of LURMP Policy Agriculture P-4 regarding the Right to Farm Ordinance.</li> <li>▪ <b>Agriculture P-9:</b> See the discussion of LURMP Policy Agriculture P-4 above.</li> </ul> |
| A10-1     |           | <p>Thank you for the opportunity to review and provide comments on the Draft Envision Stockton 2040 General Plan Update and Draft Environmental Impact Report (Draft EIR) for the General Plan Update and Utility Master Plan Supplements. Delta Stewardship Council (Council) staff also appreciated the opportunity to attend a workshop on the General Plan Update on July 30, 2018 and to discuss certain aspects of the General Plan Update and Draft</p> | <p>This comment is an introductory statement that provides general information about the Delta Reform Act and does not address the adequacy of the Draft EIR. The comment is acknowledged and will be forwarded to the decision-making bodies as part of the Final EIR for their consideration in reviewing the project. No further response is required.</p>   |

## COMMENTS AND RESPONSES

| Comment # | Date | Comment   | Response  |
|-----------|------|---|---|
|           |      | <p>EIR with you via telephone on August 6, 2018.</p> <p>The Council is an independent State of California agency established by the Sacramento-San Joaquin Delta Reform Act of 2009 (SBX7 1; Delta Reform Act). The Council is charged with furthering California's coequal goals for the Delta through the adoption and implementation of the Delta Plan, regulatory portions of which became effective on September 1, 2013.</p> <p>As stated in the Delta Reform Act, the State has "'coequal goals' (which) means two goals of providing a more reliable water supply for California and protecting, restoring, and enhancing the Delta ecosystem. The coequal goals shall be achieved in a manner that protects and enhances the unique cultural, recreational, natural resource, and agricultural values of the Delta as an evolving place" (Water Code section 85054).</p> <p>Through the Delta Reform Act, the Council was directed to review and provide timely advice to local and regional planning agencies regarding the consistency of local and regional planning documents with the Delta Plan. The Council's input includes, but is not limited to, reviewing the consistency of local and regional planning documents with the ecosystem restoration needs of the Delta and reviewing whether the lands set aside for natural resource protection are sufficient to meet the Delta's ecosystem needs. (Water Code section 85212).</p> |   |
| A10-2     |      | <p><b>Covered Action Status</b></p> <p>Through the Delta Reform Act, the Council was granted specific regulatory and appellate authority over certain actions of State or local public agencies that take place in whole or in part in the Delta. To do this, the Delta Plan contains a set of regulatory policies with which State and local agencies are required to comply. The Delta Reform Act specifically established a certification process for compliance with the Delta Plan. This means that State and local agencies that propose to carry out, approve, or fund a qualifying action in whole or in part in the Delta, called a "covered action," must certify that this covered action is consistent with the Delta Plan and must file a certificate of consistency with the Council that includes detailed findings.</p> <p>As noted in the Draft General Plan, most of the western portion of Stockton's Planning Area is located within the Legal Delta, and thus subject to State oversight through the Delta Plan. The City of Stockton (City) has identified the need for the General Plan to be consistent with the Delta Plan</p>   | <p>This comment provides general information on the Delta Reform Act and covered action status, and does not specifically address the adequacy of the Draft EIR. The comment is acknowledged for the record and will be forwarded to the decision-making bodies as part of the Final EIR for their consideration in reviewing the project. No further response is required.</p> |

## COMMENTS AND RESPONSES

| Comment # | Date | Comment  | Response   |
|-----------|------|--|--|
|           |      | <p>(Draft General Plan, p. 3-17). The City has also identified that the Delta Plan includes a requirement for consistency findings for covered actions, which include the proposed General Plan (Draft EIR, pp. 4.2-3, 4.4-6, 4.10-4). The City also acknowledges the role of the Delta Plan's policies to address flood protection for residential development and limit encroachment in floodplains (Draft EIR, p. 4.9-7).</p> <p>It should be noted that the Delta Reform Act establishes specific criteria and categories for exempting actions from the Council's regulatory authority. One of these exemptions is for actions within the Secondary Zone of the Delta that a metropolitan planning organization determines are consistent with its sustainable communities strategy (SCS). Such proposed actions are not covered actions regulated by the Council (Water Code section 85057.5(b)(4)).</p> <p>The Draft EIR analyzes consistency with the San Joaquin Council of Governments' (SJCOG) 2014 Regional Transportation Plan/Sustainable Communities Strategy (RTP/SCS) (Draft EIR, p. 4.10-18). An updated 2018 RTP/SCS was adopted by SJCOG on June 28, 2018. With respect to land use, the 2018 RTP/SCS is consistent with the Delta Plan. The City may request an evaluation of the updated General Plan's consistency with SJCOG's 2018 RTP/SCS. If SJCOG determines that the updated General Plan is consistent, the proposed project would be exempt from the Council's covered action process.</p> <p>Additional information on covered actions and the certification process can be found on the Council website, <a href="http://deltacouncil.ca.gov/covered-actions">http://deltacouncil.ca.gov/covered-actions</a>.</p> |  |
| A10-3     |      | <p><b><u>Comments on the Draft General Plan</u></b></p> <p>Based on our review, Council staff has not identified any specific inconsistency between the Draft General Plan and the Delta Plan pursuant to Water Code section 85212. In fact, several General Plan policies align with the Delta Reform Act and the Delta Plan, including the following:</p> <ul style="list-style-type: none"> <li>• <b>General Plan Land Use Designations.</b> Council staff is pleased to see that the General Plan Update will re-designate areas depicted as "Village" in the southern portion of the Planning Area to "Open Space/Agriculture". The Council supports this proposed change, which contributes to consistency between the General Plan and the Delta Plan.</li> </ul> <p>Other land use designation changes in the Planning Area within the</p>   | <p>The comment expresses support for aspects of the proposed project and does not address the adequacy of the Draft EIR. Please see Master Response # 1, Project Merits, in Section 5.1 of this chapter.</p> |

## COMMENTS AND RESPONSES

| Comment # | Date | Comment   | Response   |
|-----------|------|---|--|
|           |      | <p>secondary zone of the Legal Delta appear to align with <b>Delta Plan Policy DP P1, Locate New Urban Development Wisely</b> (23 Cal. Code of Regs. section 5010). This includes redesignation of areas north of the City Limits from "Village" to "Economic and Education Enterprise," as the subject area was previously designated for development in the City's General Plan as of the date of the Delta Plan's adoption (May 16, 2013).</p> <ul style="list-style-type: none"> <li>• <b>Climate Change.</b> The Council supports General Plan Policy CH-5.1A which outlines the City's intention to conduct a "comprehensive climate change vulnerability assessment to inform the development of adaptation and resilience policies and strategies". In a closely related effort, over the next couple of years, the Council will be undertaking a Climate Change Vulnerability Assessment and Adaptation Strategy for the Sacramento - San Joaquin Delta that seeks to incorporate stakeholder input, best available science, and identifies specific high-priority options for adapting to the changing climate. Council staff look forward to working with the City as a collaborative stakeholder in this process.</li> </ul>  |  |
| A10-4     |      | <p>Council staff requests the City incorporate the following technical correction to the Draft General Plan regarding the Delta Plan:</p> <ul style="list-style-type: none"> <li>• Land Use Element, p. 3-17, second paragraph. Please change the reference to the "Delta Reform Plan" to the "Delta Plan."</li> </ul>  | <p>This comment requests a correction to the proposed project and does not address the adequacy of the Draft EIR. The comment is acknowledged for the record and will be forwarded to the decision-making bodies as part of the Final EIR for their consideration in reviewing the project. No further response is required.</p>                                       |
| A10-5     |      | <p><b><u>Comments on the Draft EIR</u></b></p> <p>Council staff appreciates the City's consideration and incorporation of comments we offered on the Notice of Preparation (NOP) for the 2040 General Plan Update and Utility Master Plan Supplements EIR in a letter dated June 22, 2017.</p> <p>Council staff notes that the City evaluates the potential for conflict with the Delta Plan within the Draft EIR in the discussion of Impact LU-2, on p. 4.10-23. The analysis focuses on how General Plan goals SAF-3 (Sustain Clean and Adequate Water Supplies) and LU-5 (Protect, Maintain, and Restore Natural and Cultural Resources) and associated policies support the coequal goals. The analysis also identifies that, as discussed above, the proposed General Plan does not allow new residential, commercial, or industrial development in the Delta that was not already allowed in the existing 2007 General Plan, noting consistency with Delta Plan Policy DP P1. The City concludes that implementation of the proposed General Plan policies and actions would support, rather than conflict with the Delta Plan. This information will be useful for the City to present as part of the record accompanying a certification of consistency with the Delta Plan, should it be determined that the General Plan Update is a covered action.</p> | <p>This comment summarizes the Draft EIR's findings with respect to consistency with the Delta Plan; it does not address the adequacy of the Draft EIR. The comment is acknowledged for the record and will be forwarded to the decision-making bodies as part of the Final EIR for their consideration in reviewing the project. No further response is required.</p> |

**COMMENTS AND RESPONSES**

| Comment #  | Date             | Comment   | Response   |
|------------|------------------|---|--|
| A10-6      |                  | <p><b>Closing Comments</b><br/>                     We encourage the City to continue early consultation with Council staff and to work collaboratively with SJCOG, as appropriate, to discuss the consistency certification process for the General Plan Update. Continued consultation is an important step to ensure consistency between the 2040 General Plan and the Delta Plan, so that the two plans are complementary and serve to protect the Delta. Please contact Kate Anderson of my staff at (916) 445-5028 or kate.anderson@deltacouncil.ca.gov with any questions, comments, or concerns.</p>  | <p>This comment serves as a closing statement and does not address the adequacy of the Draft EIR. The comment is acknowledged for the record and will be forwarded to the decision-making bodies as part of the Final EIR for their consideration in reviewing the project. No further response is required.</p>   |
| <b>A11</b> | <b>8/10/2018</b> | <b>San Joaquin Bike Coalition</b>   |  |
| A11-1      |                  | <p>On behalf of the San Joaquin Bike Coalition, I am writing to share our comments on the City of Stockton Draft General Plan and Environmental Impact Report. We appreciate the effort and outreach that went in to this document, which largely indicates a vast improvement on previous General Plan efforts, and how it supports a shift towards enhanced bikeability and walkability for residents of the City of Stockton.</p>  | <p>This comment serves as an opening remark and does not address the adequacy of the Draft EIR. The comment is acknowledged for the record and will be forwarded to the decision-making bodies as part of the Final EIR for their consideration in reviewing the project. No further response is required.</p>   |
| A11-2      |                  | <p>There are a few areas which, with minimal attention, we believe could strengthen the overall impact of the Plan if modified.</p> <p><b>- Support the Infill Focus Alternative for the General Plan, which is the environmentally superior alternative to the currently proposed General Plan.</b><br/>                     We believe our city needs to grow upwards before we grow outwards. Expanding the overall footprint of the city will stretch transportation resources (among others) and decrease the feasibility of bicycle commuting from the outskirts of the City to major employment centers. SJBC participated in the comprehensive public outreach that took place, and find it concerning that the proposed General Plan footprint and development north of Eight Mile Road does not appear to take into consideration the overall public preference towards the Infill Focus Alternative.</p> | <p>The comment expresses a general opinion about the proposed project and does not address the adequacy of the Draft EIR. Please see Master Response #1, Project Merits, in Section 5.1 of this chapter.</p>   |
| A11-3      |                  | <p><b>- Emphasize planning decisions that support overall mode shift and transportation choice by planning for people over vehicles.</b> We support the shift to using alternative models to Level of Service to analyze overall roadway efficiency, such as Vehicle Miles Travelled. It is our opinion that supporting transportation choice by building bicycle and pedestrian facilities will, over time, have a positive impact on property value, economic development, quality of life, and air quality. The current Level of Service measures used to assess impact do not appear to take into consideration these qualities beyond simply the efficiency with which a car can travel.</p>   | <p>Proposed General Plan Action TR-4.2B would amend the City's Transportation Impact Analysis (TIA) Guidelines to reflect the change from level of service (LOS) to vehicle miles traveled (VMT) as the primary transportation metric for the purposes of CEQA, and to include alternative travel metrics and screening criteria. While LOS calculations may still be required, it is envisioned that the updated TIA guidelines would include analysis requirements related to evaluating a project's effects on the pedestrian, bicycle, and transit networks, as well as a project's consistency with adopted plans related to non-auto travel. Although the City's current transportation metric to evaluate impacts under CEQA relies on LOS (evaluated on pages 4.14-27 to 4.14-34 of the Draft EIR), a discussion of VMT under the proposed General Plan is provided for informational purposes on pages 4.14-39 to 4.14-42 of the Draft EIR.</p> |

## COMMENTS AND RESPONSES

| Comment #  | Date             | Comment   | Response  |
|------------|------------------|---|---|
| A11-4      |                  | <p><b>- Address the shortage of and need for safe bicycle parking in already established areas of the city.</b> Identified as a major issue of concern in the recently adopted Bicycle Master Plan, bicycle parking is nearly nonexistent in much of the existing footprint of Stockton. While the draft EIR appears to mandate bicycle parking in new developments, it does not clearly address the issue of the current shortage.</p>   | <p>The proposed General Plan includes Action TR-2.1B to maintain and implement the City of Stockton Bicycle Master Plan. The adopted Bicycle Master Plan includes policies and actions related to providing short-term and long-term bicycle parking at transit stops, as well as guidance for developing a Citywide Bicycle Parking Program that is aimed at existing developments. Adoption of the proposed General Plan would support implementation of the Bicycle Master Plan, and by extension provide guidance for the provision of additional bicycle parking in already developed portions of the City.</p> <p>To clarify, the Draft EIR does not mandate bicycle parking; rather, proposed General Plan Action TR-2.1A requires bicycle parking in new development. This is not a comment on the adequacy of the analysis in the Draft EIR.</p> |
| A11-5      |                  | <p>We appreciate the time and effort from both the public and City staff that has gone into this planning process. With the aforementioned changes, we would be happy to place our support behind the General Plan as it supports the City's comprehensive Bicycle Master Plan and SJBC's vision of a community where bicycling is a safe and preferred method of transportation and recreation. Thank you for your consideration.</p>  | <p>This comment is a closing statement and does not address the adequacy of the Draft EIR. The comment is acknowledged and will be forwarded to the decision-making bodies as part of the Final EIR for their consideration in reviewing the project. No further response is required.</p>  |
| <b>A12</b> | <b>8/10/2018</b> | <b>San Joaquin Council of Governments</b>   |   |
| A12-1      |                  | <p>Thank you for the opportunity to review the Draft Envision 2040 General Plan Update and associated Draft Environmental Impact Report As the County's designated Regional Transportation Planning Agency (RTPA), Metropolitan Planning Organization (MPO), Congestion Management Agency (CMA), Airport Land Use Commission (ALUC), and Travel Demand Management Program (Dibs), the San Joaquin Council of Governments (SJCOG) has the following comments:</p>  | <p>This comment serves as an opening remark and does not address the adequacy of the Draft EIR. The comment is acknowledged for the record and will be forwarded to the decision-making bodies as part of the Final EIR for their consideration in reviewing the project. No further response is required.</p>  |
| A12-2      |                  | <p><b><u>COMMENTS ON 2040 ENVISION STOCKTON GENERAL PLAN DEIR</u></b></p> <p><b><u>RTPA/MPO's Review</u></b><br/>                     SJCOG has analyzed Section 4.14 Transportation and Traffic of the DEIR and the associated appendices C, E, and F. SJCOG is supportive of the multimodal focus of the future transportation network envisioned by the 2040 General Plan. SJCOG suggests a meeting with City of Stockton to confirm open-to-traffic dates for projects identified in the Technical Memorandum, and to determine whether any modifications to the Regional Model are required. We believe that any necessary modifications can be dealt with via a Regional Transportation Plan amendment or through the adoption of the 2022 Regional Transportation Plan, depending upon the open-to-traffic dates associated with network improvements.</p> | <p>The comment expresses a general opinion about the proposed project and suggests future agency coordination regarding future transportation projects. It does not address the adequacy of the Draft EIR. The comment is acknowledged and will be forwarded to the decision-making bodies as part of the Final EIR for their consideration in reviewing the project. No further response is required.</p>  |



**COMMENTS AND RESPONSES**

| Comment # | Date | Comment   | Response  |
|-----------|------|---|---|
| A12-3     |      | <p><b><u>Congestion Management Agency's Review</u></b><br/>                     As noted on page 4.14-23 of the DEIR, "SJCOG is the designated Congestion Management Agency (CMA) for San Joaquin County. As such, they are required to maintain the State-mandated Regional Congestion Management Program (RCMP) for roadways within the county. The LOS Standard for RCMP facilities is LOS D. If a CMP segment operates worse than LOS E (i.e., LOS F), then the jurisdiction in which the segment is located must prepare a deficiency plan.</p> <p><i>RCMP facilities within the EIR Study Area include: Interstate 5, State Route 99, State Route 4, State Route 88, State Route 26, Eight Mile Road, Hammer Lane, March Lane, Sperry Road, French Camp Road, Trinity Parkway, Thornton Road, Pacific Avenue, West Lane, Airport Way, Mariposa Road, and Austin Road."</i></p> <p>While the DEIR addressed various areas within the City of Stockton "to reduce the severity of potential LOS impacts," found on pages 2-23 to 2-27, on page 4.14-23, the DEIR did not note Lower Sacramento Road, Arch Road, Navy Drive, Roth Road, Jack Tone Road, and Matthews Road under the list of RCMP facilities. All of these facilities lie within the General Plan Area, identified in the Notice of Availability. SJ COG recommends that impacts to these facilities be analyzed and incorporated into the Final Environmental Impact Report.</p> | <p>As shown in Chapter 3 of this Final EIR, Lower Sacramento Road, Arch Road, Navy Drive, Roth Road, Jack Tone Road, and Mathews Road have been added to the list of Regional Congestion Management Program (RCMP) facilities. The Draft EIR analysis did include analysis of segments of Lower Sacramento Road, Arch Road, Navy Drive, and Mathews Road, as detailed in Appendix C of the Draft EIR. These segments were found to operate within established level of service ranges of both the San Joaquin Council of Governments (SJCOG) and the City of Stockton. For this Final EIR, additional analysis was conducted for segments of Roth Road and Jack Tone Road and summarized in a revised Appendix C to the Draft EIR, which is provided in Chapter 3 of this Final EIR. The results of this analysis show that the Roth Road and Jack Tone Road would continue to operate within established level of service ranges with the proposed General Plan.</p> |
| A12-4     |      | <p><b><u>Airport Land Use Commission's Review</u></b><br/>                     The Envision Stockton 2040 General Plan DEIR addressed Stockton Metropolitan Airport within the "Hazards and Hazardous Materials" section. As noted in our comment letter on the Notice of Preparation dated June 22, 2017, the proposed Stockton Sphere of Influence is located with the airport influence areas (AIA) of Lodi Airpark and Kingdon Executive Airport. SJCOG recommends the DEIR be revised to address potential impacts to the Lodi Airpark and Kingdon Executive Airport. The General Plan Planning Area lies within all the safety zones of Lodi Airpark and the following safety zones of Kingdon Executive Airport: Airport Influence Area (AIA), Traffic Pattern Zone (TPZ), Outer Approach/ Departure Zone (OADZ), Inner Turning Zone (ITZ), Inner Approach/ Departure Zone (IA.DZ), and Runway Protection Zone (RPZ). Please reference the 2018 San Joaquin County Airport Land Use Compatibility Plan (ALUCP) (<a href="https://www.sjcog.org/ALUC">https:// www.sjcog.org/ALUC</a>).</p>   | <p>In response to this comment, a discussion of the Lodi Precissi Airpark and Kingdon Executive Airport has been added to Sections 4.8, Hazards and Hazardous Materials, 4.10, Land Use and Planning, and 4.11, Noise, of the Draft EIR, as shown in Chapter 3 of this Final EIR.</p>   |
| A12-5     |      | <p><b><u>COMMENTS ON 2040 ENVISION STOCKTON GENERAL PLAN</u></b><br/> <b><u>Congestion Management Agency's Review</u></b><br/>                     As noted on page 4-4 of the Draft General Plan, "The San Joaquin Council of</p>  | <p>The comment expresses opinions about and suggests edits to the proposed project and does not address the adequacy of the Draft EIR. Please see Master Response # 1, Project Merits, in Section 5.1 of this chapter.</p>  |

## COMMENTS AND RESPONSES

| Comment # | Date | Comment  | Response |
|-----------|------|--|----------|
|           |      | <p>Governments (SJCOG) coordinates transportation planning and financing for the region and administers regional plans that promote sustainable growth, including the Regional Transportation Plan &amp; Sustainable Communities Strategy that guides funding and policy decisions, the Regional Congestion Management that identifies regionally significant roadways, and the Smart Growth Transit-Oriented Development Plan that promotes transit-friendly land use planning and development.</p> <p>SJCOG suggests revising this statement as follows: "The San Joaquin Council of Governments (SJCOG) coordinates ... .. , the Regional Congestion Management <u>Program</u> that identifies regionally significant roadways .... "</p> <p>SJCOG recommends the following segments be added to Action TR-4.1A, under "Strive for different LOS standards along the following corridors due to physical constraints that limit improvements that can be constructed":</p> <ul style="list-style-type: none"> <li>• Eight Mile Road (1-5 to Thornton Road) - LOS F</li> <li>• Arch Airport Road (SR-99 to Airport Way) - LOS F</li> <li>• SR-4 (Fresno Avenue to Navy Drive/Stockton Street) - LOS F</li> <li>• I-5 (Hammer Lane to Eight Mile Road) - PM LOS E</li> <li>• SR-99 (Wilson Way to Hammer Lane) - PM LOSE</li> <li>• SR-99 (Cherokee Road to Wilson Way) - LOS F</li> <li>• SR-99 (SR-88 to Cherokee Road) - LOS F</li> </ul> <p>These segments were determined to be operating at deficient LOS as of the 2016 SJCOG RCMP Monitoring Report.</p> <p>SJCOG requests to be included as a stakeholder when the TIA Guidelines are updated as noted in Action TR-4.2B. We would like to review these updates for consistency with the RCMP and other regional plans.</p> <p><b><u>Airport Land Use Commission's Review</u></b></p> <p>As noted on Page 4-5 of the Draft General Plan, "POLICY TR-1.3: Facilitate expanded port and airport operations, service, and development as travel and goods movement assets to the community and sources of employment growth. (TC-7, TC-8)</p> <ul style="list-style-type: none"> <li>• <i>Action TR-1.3A - Protect the Airport and related aviation facilities from encroachment by ensuring that all future development within the Airport Influence Area (AJA) is consistent with the policies adopted by the San Joaquin County Airport Land Use Commission (ALUC), except in cases</i></li> </ul> |          |

**COMMENTS AND RESPONSES**

| Comment # | Date | Comment   | Response |
|-----------|------|---|----------|
|           |      | <p><i>where the City Council concludes that project approval would provide for the orderly development of the Airport and the areas surrounding it while protecting the public health, safety, and welfare by minimizing the public's exposure to excessive noise and safety hazards."</i></p>  |          |
|           |      | <p>SJCOG assumes the exception is based off the ALUC Overrule policy within both 2018 Stockton Metropolitan (SM) (page 3-13) and San Joaquin County (SJC) Airport Land Use Compatibility Plan (ALUCP) (page 3-9).</p>   |          |
|           |      | <p><i>As noted on Page 4-7 of the Draft General Plan, "Action TR-I.3B - Where substantial development already exists within the AJA and is incompatible with ALUC policies, only allow additional infill development of similar land uses if projects meet all of the following criteria to be an infill project:</i></p>   |          |
|           |      | <ul style="list-style-type: none"> <li><i>• The proposed project does not otherwise increase the intensity and/or incompatibility of use through use permits, density transfers, or other strategies. (LU-6.4) (Page 4-7)</i></li> </ul>  |          |
|           |      | <p>SJCOG requests clarity on Action TR-I.3B eligibility criteria #3, "The proposed project does not otherwise increase the intensity and/or compatibility of use through use permits, density transfers, or other strategies (page 4-7)." SJ COG recommends the inclusion of all criteria, not previously mentioned in Policy TR-I.3A of 2018 ALUCP (2018 SMALUCP, Page 3-26 to 3-27 &amp; 2018 SJCALUCP, Page 3-17 to 3-18).</p>   |          |
|           |      | <p>SJCOG recommends the inclusion of FAA notification requirement, as found in page 3-40 of SMALUCP and page 3-28 of SJCALUCP as follows:</p>   |          |
|           |      | <p><i>"Proponents of a project involving objects that may exceed a CFR Part 77 surface must notify the Federal Aviation Administration as required by CFR Part 77, Subpart B, and by the PUC, Sections 21658 and 21659. (Notification to the Federal Aviation Administration under CFR Part 77, Sub-part B, is required even for certain proposed construction that does not exceed the height limits allowed by Subpart C of the regulations. Refer to Appendix D for the specific FAA notification requirements.)</i></p> |          |
|           |      | <ul style="list-style-type: none"> <li><i>• Local jurisdictions shall inform project proponents of the requirements for notification to the FAA</i></li> <li><i>• The requirement for notification to the FAA shall not necessarily trigger an airport compatibility review of an individual project by the ALUC if the project is otherwise in conformance with the compatibility criteria established herein.</i></li> </ul>  |          |

## COMMENTS AND RESPONSES

| Comment # | Date | Comment   | Response |
|-----------|------|---|----------|
|           |      | <ul style="list-style-type: none"> <li>• <i>FAA review is required for any proposed structure more than 200 feet above the surface level of its site. All such proposals shall also be submitted to the ALUC for review regardless of where in the county they would be located.</i></li> <li>• <i>Any project submitted to the ALUC for airport land use compatibility review for which FAA notification is required shall include a copy of the CFR Part 77 notification to the Federal Aviation Administration and the FAA findings if available.</i></li> </ul>   |          |
|           |      | <p><i>In addition, FAA notification is required for owners or operators proposing to site new, or expand existing, Municipal Solid Waste Landfills (MSWLFs) within a five-mile radius of any airport runway (CFR 40, Subchapter 1, Part 258, Subpart B, Section 258.10). FAA Form 7460-1, Notice of Proposed Construction or Alteration, or other suitable document similar to FAA Form 7460-1 may be used to notify the appropriate FAA Regional Airports Division Office of a planned siting or expansion of a MSWLF, as well as other potential wildlife attractants. "</i></p>  |          |
|           |      | <p><b><u>Transportation Demand Management (aka Dibs Program) Review</u></b><br/> <i>As noted on Page 4-11 of the Draft General Plan, "Policy TR-3.2: Require new development and transportation projects to reduce travel demand, support electric vehicle charging, and accommodate multi-passenger autonomous vehicle travel as much as feasible.</i></p> <ul style="list-style-type: none"> <li>• <i>Action TR-3.2A - Amend the parking requirements in the Development Code to encourage shared parking, require preferential parking for rideshare vehicles, and allow reduced parking requirements to support transit, bicycling, and walking. (TC-2.21)</i></li> <li>• <i>Action TR-3.2B - Require commercial, retail, office, industrial, and multifamily residential development to provide charging stations and prioritized parking for electric and alternative fuel vehicles. (NCR-8.9)</i></li> <li>• <i>Action TR-3.2C - Respond to the implications and opportunities associated with connected vehicles and autonomous vehicles by monitoring technological advances and adjusting roadway infrastructure and parking standards to accommodate autonomous vehicle technology and parking needs.</i></li> </ul> |          |
|           |      | <p>SJCOG recommends revising the Draft General Plan to include the following actions:</p>   |          |
|           |      | <ul style="list-style-type: none"> <li>• <i>Require adding park and ride lots for large developments located near</i></li> </ul>  |          |

**COMMENTS AND RESPONSES**

| Comment # | Date | Comment  | Response |
|-----------|------|--|----------|
|           |      | <p>areas of priority as listed in the San Joaquin County Regional Park and Ride Lot Master Plan and future updates. These facilities were envisioned in the 2035 General Plan and many are required as conditions of approval for development projects that have been approved by the City. These park and ride lots need to provide easy access to freeways and be available to carpools, vanpools, and commuter buses.</p> <ul style="list-style-type: none"> <li>Commercial, retail, office, industrial and multifamily residential development should be required to prepare a Transportation Demand Management Plan, to support the Active and Mobile Community Goals, that may include on-site amenities, bike parking, shower facilities, lockers, preferential parking, transportation information kiosks, EV charging stations and park and ride spaces as much as feasible.</li> <li>Mitigate potential air quality impacts by requiring large employers and business parks based on employment size to submit a Transportation Demand Management Plan.</li> </ul> |          |
|           |      | <p>As noted on Pages 5-24 and 5-25 of the Draft General Plan, "<i>Policy SAF-4.2: Encourage major employers to participate in a transportation demand management program (TDM) that reduces vehicle trips through approaches such as carpooling, vanpooling, shuttles, car-sharing, bikesharing, end-of trip facilities like showers and bicycle parking, subscription bus service, transit subsidies, preferential parking, and telecommuting</i></p> <ul style="list-style-type: none"> <li><i>Action SAF-4.2A - Provide information and conduct marketing and outreach to major existing and new employers about the transportation demand management (TDM) program facilitated by the San Joaquin Council of Governments.</i></li> </ul>   |          |
|           |      | <p>SJCOG recommends modifying the Policy SAF-4.2 language as follows:</p> <ul style="list-style-type: none"> <li>Require all new large employers to work with the San Joaquin Council of Governments dibs program to implement a transportation demand management plan to address elements such as California's Parking Cash-Out Program, vanpooling/carpooling, transit, Emergency Ride Home Program, Preferential Parking, telecommuting, bicycle parking and on-site amenities, and rideshare and transit incentives.</li> </ul>  |          |
|           |      | <p>SJCOG recommends adding the following new policy.</p> <ul style="list-style-type: none"> <li>Support San Joaquin Valley Air Pollution Control District Rule 9410 by requiring employers of 100 or more employees to work with the San Joaquin Council of Government's dibs program to develop and implement a Trip Reduction Program (eTrip).</li> </ul>  |          |

## COMMENTS AND RESPONSES

| Comment # | Date | Comment   | Response |
|-----------|------|---|----------|
|           |      | <p><b><u>RTPA/MPO's Review</u></b></p> <p>As noted on page 3-6 of the Draft General Plan, "POLICY LU-2.2: Facilitate the development of at least 4,400 new housing units in the Greater Downtown by 2040.</p> <ul style="list-style-type: none"> <li>• Action LU-2.2A - Amend the Development Code to provide more flexibility for residential development to be feasible, including through a streamlined residential development permit process, and to contribute to the "charm" of the Downtown." (DV-2.3)</li> <li>• Action LU-2.2B - Establish Transit Oriented Development (TOD) Overlay Zones around the Robert J Cabral ACE Train Station and the San Joaquin Street Amtrak Station to promote high-density residential, including affordable and mixed-income housing, and other TOD.(DV-2.2)"</li> </ul> <p>Senate Bill 375 (SB 375) provides for some CEQA streamlining relating to growth inducing impacts and impacts from certain vehicle trips for development projects meeting detailed criteria. SJCOG encourages the City to work with SJCOG on the self-certification process for consistency with the RTP/SCS to facilitate streamlining provisions on applicable "transit priority projects."</p> <p>The 2018 Regional Transportation Plan and Sustainable Communities Strategy (2018 RTP/SCS) recognizes "high-quality" transit as defined by SB 375 to include not only the transit hubs listed (rail stations), but also certain bus transfer stations with two or more major bus routes with a frequency of service interval of 15 minutes or less during peak commute periods and transit corridors meeting the 15-minute interval criteria. SJ COG encourages the addition of these facilities to Action LU-2.2B.</p> <p>As noted on page 3-6 of the Draft General Plan, "Action LU-2.2C - Evaluate and implement adjustments to the Public Facilities Fee structure to promote development in the Downtown. (DV-2.4)"</p> <p>SJCOG encourages use of the fee discount offered through the Regional Transportation Impact Fee (RTIF) program for development projects meeting specific criteria for "infill projects" and as outlined in the currently adopted program operating agreement to help the City implement this policy action.</p> <p>As noted on page 4-5 of the Draft General Plan, "POLICY TR-1.1: Ensure that roadways safely and efficiently accommodate all modes and users, including</p> |          |

**COMMENTS AND RESPONSES**

| Comment # | Date | Comment   | Response |
|-----------|------|---|----------|
|           |      | <p><i>private, commercial, and transit vehicles, as well as bicycles and pedestrians and vehicles for disabled travelers. (TC-1.2, TC-1.3)</i></p> <ul style="list-style-type: none"> <li>• <i>Action TR-1.3A - Protect the Airport and related aviation facilities from encroachment by ensuring that all future development within the Airport Influence Area (AIA) is consistent with the policies adopted by the San Joaquin County Airport Land Use Commission (ALUC), except in cases where the City Council concludes that project approval would provide for the orderly development of the Airport and the areas surrounding it while protecting the public health, safety, and welfare by minimizing the public's exposure to excessive noise and safety hazards. (LU-6.1, LU-6.2, HS-2.8)"</i></li> </ul>  |          |
|           |      | <p>SJCOG suggests inclusion of language referring to Section 3.1.8 in the currently adopted Airport Land Use Compatibility Plan (ALUCP) for Stockton Metropolitan Airport describing ALUC policies for overruling plan consistency determinations by the ALUC.</p>  |          |
|           |      | <p>As noted on page 5-19 of the Draft General Plan, "<i>POLICY SAF-2. 5 Protect the community from health hazards and annoyance associated with excessive noise levels. (HS-2)</i></p> <ul style="list-style-type: none"> <li>• <i>Action SAF-2. 5A Prohibit new commercial, industrial, or other noise-generating land uses adjacent to existing sensitive noise receptors such as residential uses, schools, health care facilities, libraries, and churches if noise levels are expected to exceed 70 dBA Community Noise Equivalent (CNEL) (decibels on A-weighted scale CNEL) when measured at the property line of the noise sensitive land use. (HS-2.1)</i></li> <li>• <i>Action SAF-2. 5B Require projects that would locate noise sensitive land uses where the projected ambient noise level is greater than the "normally acceptable" noise level indicated on Table 5-1 to provide an acoustical analysis that shall:</i> <ul style="list-style-type: none"> <li>○ <i>Be the responsibility of the applicant;</i></li> <li>○ <i>Be prepared by a qualified person experienced in the fields of environmental noise assessment and architectural acoustics;</i></li> <li>○ <i>Include representative noise level measurements with sufficient sampling periods and locations to adequately describe local conditions;</i></li> <li>○ <i>Estimate existing and projected (20-year) noise levels in terms of Ldn/CNEL and compare the levels to the adopted noise policies and actions in this General Plan;</i></li> <li>○ <i>Recommend appropriate mitigation to achieve compatibility with the adopted noise policies and standards;</i></li> <li>○ <i>Where the noise source in question consists of intermittent single</i></li> </ul> </li> </ul> |          |

## COMMENTS AND RESPONSES

| Comment #        | Date             | Comment  | Response  |
|------------------|------------------|--|---|
|                  |                  | <p><i>events, address the effects of maximum noise levels in sleeping rooms in terms of possible sleep disturbance;</i></p> <ul style="list-style-type: none"> <li>o <i>Estimate noise exposure after the prescribed mitigation measures have been implemented;</i></li> <li>o <i>If the project does not comply with the adopted standards and policies of this General Plan, provide acoustical information for a statement of overriding considerations for the project; and</i></li> <li>o <i>Describe a post-project assessment program, which could be used to evaluate the effectiveness of the proposed mitigation measures. (HS-2.2, HS-2. 3, HS-2.13)</i></li> </ul> <p>SJCOG recommends including a reference to SEL Noise Exposure Contours maps included as Exhibit 3B in the currently adopted Airport Land Use Compatibility Plan (ALUCP) for Stockton Metropolitan Airport.</p> <p>Thank you again for the opportunity to comment. SJCOG looks forward to reviewing the Final EIR and the Final Envision Stockton 2040 General Plan documents.</p> |   |
| Attachment A12-1 |                  | RCMP Roadway Network   | The attachment to the comment letter is acknowledged for the record and will be forwarded to the decision-making bodies as part of the Final EIR for their consideration in reviewing the project.  |
| Attachment A12-2 |                  | Exhibit of Project Site Location in Relation to ALUC   | The attachment to the comment letter is acknowledged for the record and will be forwarded to the decision-making bodies as part of the Final EIR for their consideration in reviewing the project.  |
| <b>A13</b>       | <b>8/10/2018</b> | <b>The Sierra Club</b>   |   |
| A13-1            |                  | <p>David:</p> <p>The Sierra Club and Campaign for Common Ground submitted previous extensive comments on the draft General Plan document and the Draft EIR in a letter to the Planning Commission dated July 23, 2018. We incorporate by reference all of those previously submitted comments on the adequacy of the DEIR into this second letter and add the following additional comments. We also incorporate by reference the comments in a third letter from the Sierra Club, submitted by members of the local Delta Sierra Group. Please ensure that the Final EIR responds in detail to all of the comments in these three letters from the Sierra Club, as well as the comments received from all other interested parties.</p>   | This comment serves as an opening remark. Please refer to the responses to the comments in Comment Letters A03 and A08 for the comments incorporated by reference.  |
| A13-2            |                  | <p><b>Background on Proposed Growth North of Eight Mile Road</b></p> <p>On July 25, 2017, the City Council considered three options prepared by staff to implement an economic development strategy by reserving land north of</p>   | This comment provides background information about the proposed project and does not address the adequacy of the Draft EIR. The comment is acknowledged for the record and will be forwarded to the decision-making bodies as part of the Final EIR for their |



**COMMENTS AND RESPONSES**

| Comment # | Date | Comment   | Response   |
|-----------|------|---|--|
|           |      | <p>Eight Mile Road. During the discussion, City planning staff noted that the amount of land that would be needed for a Tesla factory or a Cal State campus would be in the range of 500 acres. The City Manager forcefully urged the Council to designate the entire Spanos holding of 3,800 acres (not just the 500 acres identified as necessary for economic development) for a huge job-generator to give the City and a potential developer maximum flexibility. There was no discussion about allowing housing north of Eight Mile Road. The City Council agreed to the manager’s request.</p> <p>Fast forward to July 2018 and the city releases the proposed General Plan and the DEIR. The draft plan defines the newly re-named “Economic and Education Enterprise” land use designation that applies to the Spanos lands and suddenly housing has been added into the equation, as follows:</p> <p>Development in this designation is intended to support the City’s economic development goals by attracting new businesses, industries, and/or educational institutions that provide high-quality jobs to the local workforce...Businesses envisioned for this designation include those within a Core Business Cluster industry, as specified in the City’s Economic Development Strategic Plan, that provide a significant number of jobs offering wages averaging above Area Median Income, and that cannot be reasonably accommodated elsewhere within the city limit... <u>The designation also allows proximate housing stock that supports the job-generator, including single-family, multi-family, and/or mixed-use dwellings at various levels of affordability, with housing costs that generally correspond to the income levels of the jobs generated by the project....</u> (emphasis added) (page 2-14 of the draft General Plan)</p> <p>The amount of housing that is forecast for the Economic and Education Enterprise zone is quite substantial: 26,710 housing units. This amount of housing planned for the land north of Eight Mile Road (or the potential for any housing at all) was never discussed previously by the City Council or by this Planning Commission. The concept of building more housing at this scale north of Eight Mile Road was certainly never discussed at the public meetings we attended.</p> | <p>consideration in reviewing the project. No further response is required.</p>                |
| A13-3     |      | <p><b>The DEIR Fails to Analyze Impacts Related to Buildout of 3,800 Acres of Ag Land Designated for “Economic and Education Enterprise”</b></p> <p>The fatal flaw of the DEIR comes in its failure to analyze the environmental impacts of any development of the 3,800 acres north of Eight Mile Road, as well as other development. The DEIR justifies this failure by offering a false distinction between “spatial” and “quantitative” inputs of data. The DEIR</p>  | <p>Please see Master Response #2, Development Projections, in Section 5.1 of this chapter.</p> |

## COMMENTS AND RESPONSES

| Comment # | Date | Comment  | Response |
|-----------|------|--|----------|
|           |      | <p>notes “analyses that require a quantitative estimate of growth include traffic generation, air pollution emissions, greenhouse gas emissions, noise generation, population growth, and impacts on public services and utilities and recreation.... For these analyses, the horizon-year projection (i.e., the projected amount of development that could occur under the proposed General Plan through its horizon year of 2040) was considered “reasonably foreseeable” and was used in the analysis” (page 3-28).</p>   |          |
|           |      | <p>However, as we will see in the Table 3-3 from the DEIR (attached) and described below, the DEIR’s horizon-year projection assumes that there will be NO development of any kind within the 3,800 acres between now and 2040, so impacts related to these “quantitative” topics are ignored in the DEIR, in violation of CEQA.</p>   |          |
|           |      | <p>In contrast, “analyses that are based on spatial location only include aesthetics, agriculture, exposure to localized air pollution and noise, biological resources, cultural resources, geology, hazards and safety, hydrology and water quality, and land use. For these analyses, the question is not how much development the General Plan would allow, but where that development could potentially be located. Therefore, all potential development allowed by the land use map of the proposed General Plan was evaluated to assess impacts in these topics (i.e., full buildout of the proposed General Plan)” (page 3-28).</p> |          |
|           |      | <p>So, the DEIR includes some perfunctory analysis of the “spatial” topics related to development of the 3,800 acres, but the discussion is only limited to these topics.</p>  |          |
|           |      | <p>Table 3-3 in the DEIR (attached) is the key to understanding which development areas in the City plan have been analyzed for the full range of CEQA impacts and which areas have been ignored because projected growth is presumed to not occur until after the year 2040. The table lists the development assumptions for Study Area #1 (Eight Mile Road) in the first row. (The Study Area is defined as the area north of Eight Mile Road, as well as the “Bear Creek” projects area south of Eight Mile Road.)</p>  |          |
|           |      | <p>The table indicates that the total amount of growth projected to occur under the horizon-year projection by 2040 in the Eight Mile Road Study Area is 1,380 single family homes, 1,200 multi-family units, and 39,000 square feet of commercial space. According to staff and the DEIR consultant, this</p>   |          |

**COMMENTS AND RESPONSES**

| Comment # | Date | Comment   | Response   |
|-----------|------|---|--|
|           |      | <p>amount of growth is assumed to be located in the Bear Creek area south of Eight Mile Road, and that no growth by 2040 would occur on the 3,800 acres of Spanos lands north of Eight Mile Road.</p> <p>However, for the “full buildout” of the plan beyond year 2040, development on the Spanos lands would include 2,560 single family homes (3,940 minus the Bear Creek homes), a whopping 24,150 multi-family units, 158,000 square feet of commercial space, and over 74 million square feet of “industrial” space (which presumably includes institutional or educational uses).</p> <p>Notably, assuming 3.23 people per household, the assumption that 26,710 housing units would be constructed north of Eight Mile Road under the full buildout of the plan is equivalent to adding over 86,000 new residents to the city! This DEIR fails to analyze any of the environmental impacts of this amount of new housing growth related to traffic generation, air and greenhouse gas emissions, noise, population growth, and impacts on public services and utilities and recreation.</p>  |  |
| A13-4     |      | <p><b>The DEIR’s Use of Two Development Scenarios in the Project Description and Impact Analysis Is Misleading and Unlawful.</b></p> <p>The DEIR purports to analyze the impacts of the General Plan under two scenarios: “Full Buildout” that assumes development will occur as permitted by the General Plan, and a “Horizon-Year Projection” that assumes that development will occur at significantly less intensity than allowed under the General Plan. DEIR at 3-20 and 3-21. This dual scenario approach is unlawful and is misleading because it underestimates the impacts of the General Plan as proposed.</p> <p>The DEIR assumes the amount of housing growth by 2040 to be 41,400 units, which is only one third of the total amount of housing allowed by the General Plan land use map (120,180 units). For non-residential growth, the discrepancy is even larger: only 17% of the total 293,311,000 square feet of commercial and industrial projected at full buildout is assumed by 2040. Thus, based on the housing projections alone, the traffic, air quality, public services and other environmental impacts of the buildout of the plan are potentially underestimated by two-thirds.</p> | Please see Master Response #2, Development Projections, in Section 5.1 of this chapter.  |
| A13-5     |      | <p>The Project Description is likewise inaccurate and mischaracterizes the amount and location of growth that is allowed by the Plan. The DEIR states that “The proposed General Plan represents a substantial change in the policy framework for future development in Stockton compared to the</p>  | <p>The project description provided in Chapter 3 of the Draft EIR provides a clear description of the amount and location of development allowed by the proposed General Plan. The proposed General Plan land use map is shown in Figure 3-3 on page 3-13 of the Draft EIR, and the amount of development that would be allowed by the</p> |

## COMMENTS AND RESPONSES

| Comment # | Date | Comment   | Response   |
|-----------|------|---|--|
|           |      | <p>existing 2007 General Plan. At a macro scale, the fundamental change is from one that concentrates growth in “outfill” areas located at the periphery of the city to one that emphasizes new construction and redevelopment in existing “infill” neighborhoods.” DEIR at 3-17.</p> <p>Characterizing this proposed Plan as an “infill-oriented” land use map is not accurate. The text and Tables 3-2, 3-3, and 3-4 clearly identify where the amount of “new” growth allowed by the updated Plan is “emphasized.” Less than one-third (31%) of the new growth, excluding the development projects that were already approved under the previous Plan, is in the downtown or the existing neighborhoods (true “infill” growth).</p>      | <p>General Plan, inclusive of Action LU-6.1A, which caps development at the 2040 development projection evaluated in the EIR, is summarized on page 3-20.</p> <p>See also the response to Comment A13-44 regarding characterizing the change from the 2035 General Plan as a change from an “outfill”-oriented plan to an infill-oriented plan.</p>                      |
| A13-6     |      | <p>The amount of housing growth assumed by 2040 is 40,900 units. Of that growth, 16,400 units are located in approved, but not yet constructed, development projects within and at the periphery of the existing city limits (including Westlake Villages, Delta Cove, Sanctuary, etc.), while 11,800 units are located in approved/pending projects outside the city limits (Mariposa Lakes and Tra Vigne). The only pending or approved project located in the Greater Downtown Stockton area is the Open Window project (1,400 units).</p>   | <p>The comment summarizes the locations of pending and approved development projects and does not address the adequacy of the Draft EIR. The comment is acknowledged for the record and will be forwarded to the decision-making bodies as part of the Final EIR for their consideration in reviewing the project. No further response is required.</p>                  |
| A13-7     |      | <p>Table 3-3 identifies a total of 13,070 housing units anticipated to be built by 2040 within one of the Plan’s “study areas” within the existing city limits, including 4,220 multiple family units in the “Miner/Weber” and “El Dorado/Center Corridors,” and at the “Port/Waterfront.” Table 3-2 identifies 12,100 units as “growth from the proposed General Plan” excluding approved and pending projects (it is unclear why there is a seeming discrepancy between these two tables).</p>  | <p>To clarify, Table 3-3 identifies a total of 12,100 new housing units anticipated to be built by 2040 outside of the approved and pending development projects that are summarized in Table 3-4. This number includes 3,060 single-family units and 9,040 multi-family units. Table 3-2 reports this 12,100 figure as “Growth in 2040 from Proposed General Plan.”</p> |
| A13-8     |      | <p>So, out of the 40,900 housing units projected under the Plan by 2040, about 14% (5,620 units) of the growth may occur in the downtown, 17% (7,880 units) is assumed as infill growth in the existing neighborhoods outside of the downtown, 40% (16,400 units) consists of already approved projects at the periphery of the city limits, and the remaining 29% (11,800 units) is assumed in the projects outside the city limits.</p> <p>The additional housing growth that is allowed by the Plan, but which is not assumed by 2040, amounts to 78,800 housing units (including 26,000 units north of Eight Mile Road), with more than three-quarters of that growth occurring outside of the downtown and existing neighborhoods.</p> | <p>See the response to Comment A13-44, which clarifies the projected 2040 development within the Greater Downtown (over 7,600 units, which is almost 20 percent of the 2040 projection throughout the EIR Study Area) and the city limit as it existed in 2008 (over 21,000 units, which is over 50 percent of the 2040 development projection).</p>                     |
| A13-9     |      | <p>The Project Description and the DEIR must be re-written and recirculated to rectify this gross deficiency. The City may wish to retain an analysis of impacts for the “horizon year” of 2040, however, the City is absolutely required under the provisions of the California Environmental Quality Act</p>  | <p>Please see Master Responses #2, Development Projections, and #4, Draft EIR Revisions and Recirculation, in Section 5.1 of this chapter.</p>   |

## COMMENTS AND RESPONSES

| Comment # | Date | Comment   | Response   |
|-----------|------|---|--|
|           |      | <p>(“CEQA”) and forty years of case law to also divulge all the specific impacts, at the same level of detail as the 2040 impacts, for the full buildout of the Plan.</p>   |  |
| A13-10    |      | <p>In a 2005 case with facts analogous to the present situation, the Placer County Superior Court held that the agency must analyze the full amount of development being approved under a community plan (Sierra Watch et al. v. Placer County et al. (Placer County Superior Court No. SCV 16652)). Like the DEIR here, Placer County’s EIR assumed that full build-out of the plan would be unrealistic. The EIR reduced the level of development in the project description to a more “realistic” level that was likely to occur in the plan area. The judge found the project description to be inadequate and held, “The time to study the likely affects of specific and cumulative impacts is at the time that the potential for development is known, whether or not that development actually occurs” (citing Christward Ministry v. Superior Court (1986) 184 Cal.App.3d 180, 194; and Bozung).</p>   | <p>Please see Master Response #2, Development Projections, in Section 5.1 of this chapter. The trial court ruling cited in the comment has no force as precedent and is not relevant to the current law on the issue.</p>  |
| A13-11    |      | <p>The City has no mechanism in place to limit the amount of growth during the 22-year life of the Plan. Therefore, build-out could be reached in the next 22 years. See San Joaquin Raptor/Wildlife Rescue Center v. County of Merced (2007), 149 Cal.App.4th at 655-56.</p>   | <p>Please see Master Response #2, Development Projections, in Section 5.1 of this chapter. As explained in the response, the proposed General Plan caps the amount of development that can occur without additional environmental review to the amounts evaluated in the Draft EIR via Action LU-6.1A. In addition, proposed Action LU-6.1B ensures that there is a monitoring program in place to monitor future development.</p> |
| A13-12    |      | <p>For this reason, the EIR should have evaluated what is actually allowed under full buildout in the Plan Area over the life of the Plan. Had the DEIR properly evaluated the impacts of full development under the Plan, it would have identified additional significant impacts resulting from tens of thousands of new residential units and jobs.</p> <p>In summary, the Project that must be described and analyzed in the DEIR is the Full Buildout and not the Horizon-year Projection. The importance of this distinction is not merely theoretical. The Full Buildout allows for thousands of additional dwelling units and retail space and approximately nine times as much new commercial space and industrial space, as is assumed under the Horizon-Year Projection. Because the DEIR improperly fails to assume development as allowed under the General Plan, it significantly underestimates the Project’s impacts.</p> <p>Accordingly, the DEIR is fundamentally misleading to the public and decisionmakers, in violation of CEQA. “[O]nly through an accurate view of the project may the public and interested parties and public agencies balance the proposed project’s benefits against its environmental cost, consider appropriate mitigation measures, assess the advantages of</p> | <p>Please see Master Response #2, Development Projections, in Section 5.1 of this chapter.</p>   |

## COMMENTS AND RESPONSES

| Comment # | Date | Comment   | Response  |
|-----------|------|---|---|
|           |      | terminating the proposal and properly weigh other alternatives.” City of Santee v. County of San Diego, 214 Cal. App. 3d 1438, 1454 (1989). Thus, because the DEIR fails to describe the Project properly, it fails to serve its purpose as an informational document. See San Joaquin Raptor Rescue, 149 Cal. App. 3d at 674.  |   |
| A13-13    |      | <p><b>CEQA Requires that the DEIR Analyze the Potential Impacts of the Development as Permitted Under the General Plan.</b></p> <p>Courts have consistently held that an EIR must examine a project’s potential to impact the environment, even if the development may not ultimately materialize. <i>Bozung v. Local Agency Formation Comm’n</i>, 13 Cal. 3d 263, 279, 282 (1975). Because general plans serve as the crucial “first step” toward approving future development projects, a general plan EIR must evaluate the amount of development actually allowed by the plan. <i>City of Carmel-By-the-Sea v. Bd. of Supervisors of Monterey County</i>, 183 Cal. App. 3d 229, 244 (1986); <i>City of Redlands v. County of San Bernardino</i>, 96 Cal. App. 4th 398, 409 (2002). Thus, an agency may not avoid analysis of such development merely because historic and/or projected land use trends indicate that the development might not occur.</p>   | Please see Master Response #2, Development Projections, in Section 5.1 of this chapter.   |
| A13-14    |      | In <i>San Joaquin Raptor Rescue Center v. County of Merced</i> , 149 Cal. App. 4th 645 (2007), the Court of Appeal confirmed an agency’s obligation to describe and analyze the impacts from the whole project, and “not some smaller portion of it.” <i>Id.</i> at 654. The project at issue in <i>San Joaquin Raptor</i> was a new Conditional Use Permit (“CUP”) for an existing aggregate mine and processing operation. The new CUP authorized a maximum production level of 550,000 tons per year, which was an increase over existing levels. However, historic mine production rates indicated that actual production could be less than the theoretical maximum. Based on historic rates and projected future rates, the EIR “estimated average production of about 260,000 tons per year.” <i>Id.</i> at 655. The court held that the EIR’s identification of the estimated average in the project description, rather than the maximum level of production authorized by the CUP, violated CEQA. The court stated: “By giving such conflicting signals to decisionmakers and the public about the nature and scope of the activity being proposed, the Project description was fundamentally inadequate and misleading.” <i>Id.</i> at 655-56. | Please see Master Response #2, Development Projections, in Section 5.1 of this chapter. The case cited in the comment relates to a conditional use permit, rather than a long-range planning program. As a result, it is not relevant to the proposed project. As described in Master Response #2, CEQA does not require a worst-case analysis, only an analysis of what is reasonably foreseeable. ( <i>Laurel Heights</i> , <i>supra</i> , 47 Cal.3d at p. 396.) The Draft EIR supports the development assumptions with substantial evidence, consisting of the market study described in the Master Response. |
| A13-15    |      | The Court of Appeal in <i>Stanislaus Natural Heritage Project v. County of Stanislaus</i> , 48 Cal. App. 4th 182 (1996), reached a similar conclusion in a slightly different context. The county argued that an EIR can avoid providing a full analysis of water supply for future phases of a proposed development project because the EIR included a mitigation measure that would prevent   | Please see Master Response #2, Development Projections, in Section 5.1 of this chapter. The case cited in the comment relates to water supply, rather than buildout assumptions. As a result, it is not relevant to the proposed project.   |

**COMMENTS AND RESPONSES**

| Comment # | Date | Comment   | Response   |
|-----------|------|---|--|
| A13-16    |      | <p>development of those future phases until a water supply had been identified. The court rejected this argument and held that a lead agency must assume that a project will be developed as planned and must evaluate the impacts of the planned project, not a potential, more limited project. Id. at 205-06.</p> <p>This DEIR attempts to justify its failure to describe and analyze the entirety of the General Plan by stating that it need only evaluate “the ‘reasonably foreseeable’ direct and indirect impacts of the proposed project.” DEIR at 3-20. The City has taken the “reasonably foreseeable” language from the definition of project under the CEQA Guidelines, but has misinterpreted its meaning. Under CEQA, a project means “the whole of an action, which has a potential for resulting in either a direct physical change in the environment, or a reasonably foreseeable indirect physical change in the environment . . . .” CEQA Guidelines § 15378(a). “Reasonably foreseeable” describes the likelihood of indirect impacts; it does not suggest that an EIR need only evaluate the “reasonably foreseeable” aspects of a project. Rather, it makes clear that a project is a “whole of an action.” Here, the whole of the action is the level of development permitted under the General Plan. If the City would like to limit its analysis to a predicted amount of growth, it must also limit the allowable development to that lower level by placing those restrictions in the General Plan itself.</p> | <p>Please see Master Response #2, Development Projections, in Section 5.1 of this chapter and the responses to Comments A03-5 and A13-11.</p>  |
| A13-17    |      | <p><b>“Piecemealing” a Project Is Not Allowed Under CEQA</b></p> <p>City staff and the consultant have justified the DEIR’s failure to analyze traffic and other impacts for projects assumed not to occur by 2040 (including the 3,800 acres north of Eight Mile Road) by promising that full environmental analysis and mitigation of impacts will be prepared if and when applications are submitted sometime in the future. This approach segments the project and results in the deferral of environmental analysis. As described by the Association of Environmental Professionals, piecemealing or segmenting means dividing a project into two or more pieces and evaluating each piece in a separate environmental document, rather than evaluating the whole of the project in one environmental document. This is explicitly forbidden by CEQA, because dividing a project into a number of pieces would allow a Lead Agency to minimize the apparent environmental impacts of a project by evaluating individual pieces separately, each of which may have a less-than- significant impact on the environment, but which together may result in a significant impact. Segmenting a project may also hinder developing comprehensive mitigation strategies.</p>  | <p>Sections 4.1 through 4.15 of the Draft EIR provide a description of the Regulatory Setting, Existing Setting, and Standards of Significance under which impacts are measured, and Impact Discussion for each standard of significance in accordance with Appendix G and Appendix F of the CEQA Guidelines. A program EIR may evaluate environmental effects “at a broad level,” so long as to the extent a subsequent project is not covered, additional CEQA review occurs (see Committee for Green Foothills v. Santa Clara County Bd. of Supervisors (2010) 48 Cal.4th 32, 45). A programmatic-level document is designed to provide a level of detail for the public to be informed and decision-makers to make decisions that intelligently take into account environmental consequences consistent with CEQA Guidelines Section 15151. An advantage of using a program EIR is that it can “[a]llow the lead agency to consider broad policy alternatives and program wide mitigation measures at an early time when the agency has greater flexibility to deal with basic problems or cumulative impacts.” (CEQA Guidelines Sections 15168(a) and 15168(b)(4)). Many site-specific details may be properly deferred to a later environmental review document (see In the Bay-Delta Programmatic Environmental Impact Report Coordinated Proceedings (2008) 43 Cal.4th 1143, 1173).</p> <p>The document serves as a “first-tier” document that assesses the broad environmental impacts of a program with the understanding that more detailed site-specific</p> |

## COMMENTS AND RESPONSES

| Comment # | Date | Comment  | Response   |
|-----------|------|--|--|
|           |      | <p>CEQA prohibits such segmentation of a project. See Tuolumne County Citizens for Responsible Growth, Inc. v. City of Sonora (2007) 155 Cal.App.4th 1214, 1229 (“when one activity is an integral part of another activity, the combined activities are within the scope of the same CEQA project” and must be analyzed together); Guidelines § 15378(a) (“‘Project’ means the whole of an action, which has a potential for resulting in either a direct physical change in the environment, or a reasonably foreseeable indirect physical change in the environment.”). Breaking the project into smaller sub-projects will lead to inadequate environmental review. See, e.g., Bozung v. Local Agency Formation Commission (1975) 13 Cal.3d 263, 283-84 (CEQA mandates that “environmental considerations do not become submerged by chopping a large project into many little ones”).</p> | <p>environmental reviews may be required to assess future projects implemented under the program. As individual projects with specific site plans and facilities are proposed, the City will evaluate each project to determine the extent to which this EIR adequately addressed the potential impact of the project and to what extent additional environmental analyses may be required for each specific future project (see Public Resources Code Sections 21083.3, 21093, and 21094 and CEQA Guidelines Sections 15152, 15168, and 15183). The analytical approach of the Draft EIR for the proposed project is consistent with the Governor’s Office of Planning and Research’s General Plan Guidelines, which provides that an EIR should include a broad scope of physical development issues. California Government Code Section 65300 requires that the General Plan be comprehensive, internally consistent, and long-term. Please see the first paragraph of Chapter 1, Introduction, of the Draft EIR, where it states that the Draft EIR is intended to review potential environmental impacts associated with the adoption and implementation of the proposed Envision Stockton 2040 General Plan Update and UMPS, and to determine corresponding mitigation measures, as necessary.</p>   |
|           |      |  | <p>The proposed General Plan is a regulatory document that establishes goals and policies that guide development. No specific development projects have been identified or are proposed as part of the proposed project; therefore, the proposed project does not directly result in development in and of itself. Accordingly, the Draft EIR has been appropriately prepared as a program-level EIR consistent with CEQA Guidelines Section 15168. This EIR does not evaluate the impacts of specific, individual developments that may be allowed under the proposed General Plan and doing so would be speculative and not required by CEQA. Any specific future project that requires discretionary approval is subject to environmental review as required by CEQA. Therefore, while subsequent environmental review may be tiered off this EIR, this EIR is not intended to address impacts of individual projects. Subsequent projects will be reviewed by the City and be analyzed for conformance with the General Plan, Development Code, and other applicable federal, State, and local requirements, and subsequent project-level environmental review will be conducted per CEQA Guidelines Section 15168(c) (Use with Later Activities). As stated under Section 15168(c), subsequent activities in the program must be examined in the light of the program EIR to determine whether an additional environmental document must be prepared (CEQA Guidelines Section 15168(c)(1)). Further, CEQA Guidelines Section 15168(b) states that the use of a program EIR can provide the following advantages: (1) provide an occasion for a more exhaustive consideration of effects and alternatives than would be practical in an EIR on an individual action, (2) ensure consideration of cumulative impacts that might be slighted in a case-by-case analysis, (3) avoid duplicative reconsideration of basic policy considerations, (4) allow the lead agency to consider broad policy alternatives and program wide mitigation measures at an early time when the agency has greater</p> |



**COMMENTS AND RESPONSES**

| Comment # | Date | Comment   | Response   |
|-----------|------|---|--|
| A13-18    |      | <p>This DEIR analysis has arbitrarily divided the buildout of the General Plan into two separate projects: the development that is assumed to occur by 2040, and the remaining development that is expected after that date. The DEIR must analyze the impacts of the full level of residential, commercial, and industrial uses approved by the General Plan. The maximum level of development approved by the General Plan is the project being approved, not a “reasonably foreseeable” year 2040 scenario. Defining and analyzing “the whole of the project” being approved is a long-standing requirement under CEQA. The courts have consistently held that an EIR must examine a project’s potential to impact the environment, even if the development may not ultimately materialize. <i>Bozung v. Local Agency Formation Com.</i> (1975) 13 Cal.3d 263, 279, 282.</p> | <p>flexibility to deal with basic problems or cumulative impacts, and (5) allow reduction in paperwork.</p> <p>This EIR provides the appropriate broad programmatic-level environmental analysis necessary to allow the decision-makers to apply the General Plan as it is intended to serve the City of Stockton as a comprehensive guide for making decisions about land use, air quality, community health, public health, transportation, environmental justice, climate change, and safety.</p> <p>See also Master Response #2, Development Projections, in Section 5.1 of this chapter, regarding the “whole of the project,” and which specifically addresses the Eight Mile Road area and the development cap included in the proposed General Plan.</p> <p>Please see Master Response #2, Development Projections, in Section 5.1 of this chapter.</p>  |
| A13-19    |      | <p><b>The DEIR’s Failure to Analyze Full-Build Out Under the Proposed Plan Implicates the Entire Document.</b></p> <p>As discussed above, the DEIR assumes that only partial build-out of the development allowed under the proposed General Plan will take place by 2040. This assumption is carried out throughout the DEIR, which implicates analyses throughout the document. For example, the DEIR’s use of the Horizon-Year Projection results in a skewed traffic impact analysis because the analysis fails to include impacts from traffic associated with allowed Economic and Education Enterprise uses north of Eight Mile Road.</p>  | <p>Please see Master Response #2, Development Projections, in Section 5.1 of this chapter. The transportation forecasts reflect the likely level of development over the General Plan planning horizon, which is 2040. Land use forecasts for areas outside of the EIR Study Area are based on 2040 forecasts from the SJCOG Sustainable Communities Strategy. Travel forecasts that include full theoretical buildout levels of development within the EIR Study Area, but current growth projections outside the study area, can result in misleading model results as productions and attractions are not balanced (i.e., the model could under-assign traffic, or not fully account for travel on regional roadways if there was no receiving end for a trip).</p> <p>Additionally, the forecast model does not take into consideration some foreseeable travel changes, including increased use of transportation network companies, such as Uber and Lyft, nor the potential for autonomous vehicles, because current models have not been developed to fully evaluate these future technologies as it is difficult to validate a model to a condition that does not yet exist. Although the technology for autonomous vehicles is expected to be available over the planning horizon, the federal and State legal</p> |

## COMMENTS AND RESPONSES

| Comment # | Date | Comment  | Response   |
|-----------|------|--|--|
|           |      |  | and policy frameworks are uncertain. Initial modeling of an autonomous future indicates that with automated and connected vehicles, the capacity of the existing transportation system would increase as vehicles can travel closer together; however, these efficiencies are only realized when a high percentage of vehicles on the roadway are automated and connected. There is also the potential for vehicle travel to increase with zero-occupancy vehicles on the roadway. As the technology advances, and the federal and State legal and policy frameworks are developed, it is expected that future studies would be conducted to assess the implications of autonomous travel on Stockton roadways, which would also consider updated land use forecasts. However, the analysis presented in the Draft EIR presents likely conditions in 2040, based on current transportation trends within the City of Stockton. |
|           |      |  | Should development be proposed on the parcels north of Eight Mile Road, additional detailed land use and transportation planning would be required to identify the roadway network needed to support development in that area. However, no development is currently proposed with the area.  |
| A13-20    |      | The DEIR’s evaluation of impacts to water supply is similarly incomplete.  | Please see Master Response #2, Development Projections, in Section 5.1 of this chapter, and the responses to Comments A13-48 to A13-62.  |
| A13-21    |      | These failures are carried forth into the alternatives analysis as well. The alternatives analysis failure to account for full build-out results in an analysis that compares impacts from the alternatives to only some of the impacts that will take place under full build-out. For example, the alternatives analysis concludes that the proposed Plan and the Infill Alternative would have similar impacts associated with growth in population and housing. DEIR at 5-26. This conclusion is incorrect because the DEIR fails to take into account the thousands of additional housing units and millions of additional square feet of commercial, industrial, and institutional uses allowed under the Plan.   | Please see Master Response #2, Development Projections, in Section 5.1 of this chapter. As indicated on page 5-4 of the Draft EIR, the Infill Focus Alternative would include the policies and actions that are in the proposed General Plan, including Action LU-6.1A, which limits growth to the 2040 development projection without further environmental review.   |
| A13-22    |      | <b>The DEIR Fails to Propose Feasible Mitigation Measures to Reduce the Plan’s Significant Impacts.</b><br>An EIR is inadequate if it fails to suggest feasible mitigation measures, or if its suggested mitigation measures are so undefined that it is impossible to evaluate their effectiveness. <i>San Franciscans for Reasonable Growth v. City and County of San Francisco</i> (1984) 151 Cal.App.3d 61, 79. Of course, the City may not use the inadequacy of its impacts review to avoid mitigation: “The agency should not be allowed to hide behind its own failure to collect data.” <i>Sundstrom v. County of Mendocino</i> (1988) 202 Cal.App.3d 296, 36. The proposed General Plan update would allow development of more than 120,000 residential units (under full buildout) and more than 300 million square feet of commercial, office, and industrial uses; CEQA mandates that | Please see Master Response #2, Development Projections, in Section 5.1 of this chapter.  |

**COMMENTS AND RESPONSES**

| Comment # | Date | Comment   | Response  |
|-----------|------|---|---|
|           |      | these impacts be fully evaluated and minimized. Id.   |   |
| A13-23    |      | <p><b>The DEIR Fails to Provide Adequate Mitigation for Significant Impacts Related to Loss of Agricultural Land.</b></p> <p>The California Legislature has repeatedly asserted that preservation and protection of state farmland is an important policy goal and that CEQA is an important tool that should be used to carry out this goal. <i>Masonite Corp. v. Cnty. of Mendocino</i>, 218 Cal. App. 4th 230, 240 -241 (2013) (“our Legislature has repeatedly stated the preservation of agricultural land is an important public policy”). In particular, “[a]gricultural lands near urban areas that are maintained in productive agricultural use [such as the ones near Stockton] are a significant part of California’s agricultural heritage.... Conserving these lands is necessary due to increasing development pressures and the effects of urbanization on farmland close to cities.” Pub. Resources Code, § 10201(c). “The Legislature has also declared that CEQA is intended to effectuate this public policy.” <i>Masonite Corp.</i>, 218 Cal. App. 4th at 241.</p> <p>Here, the DEIR acknowledges that the proposed General Plan would designate more than 16,000 acres of farmlands of concern under CEQA for non-agricultural uses and would designate more than 2,400 acres of lands with active Williamson Act contracts for non-agricultural uses. DEIR at 2-7, 4.2-10, and 4.2-13. The DEIR weakly concludes in Impact AG-1:</p> <p>“Although the proposed General Plan includes policies and actions that would reduce and partially offset the conversion of farmland, it designates approximately 16,160 acres of farmlands of concern under CEQA for non-agricultural uses. Because these farmland areas are located near existing urbanized areas, they may not be viable for agricultural operations due to conflicts with nearby urbanized areas. The only way to mitigate this impact would be to prohibit any development on farmland of concern. CEQA does not require that the project be changed in order to avoid an impact, and no additional mitigation is available, resulting in a significant and unavoidable impact.”</p> <p>The DEIR includes no mitigation measures whatsoever to offset these losses of agricultural land. Id. Instead, the DEIR relies on proposed General Plan policies requiring 1:1 mitigation for loss of agricultural lands through conservation easements or fees to offset this impact. DEIR at 4.2-12.</p> <p>This General Plan policy is insufficient to reduce impacts from loss of</p> | <p>CEQA does not prohibit the conversion of agricultural land to other uses, but rather it requires the disclosure of impacts to agricultural resources. The Draft EIR adequately discloses impacts to agricultural resources. As referenced in the comment, the City of Stockton manages an existing agricultural conservation program that requires either dedication of an agricultural conservation easement at a 1:1 ratio or payment of an in-lieu agricultural mitigation fee for the conversion of farmlands of concern under CEQA; proposed General Plan Action LU-5.3C would maintain that program. The Draft EIR does not purport that the City’s existing agricultural conservation program, nor the proposed action to maintain that program, would mitigate impacts to agricultural resources. Rather, the proposed action is cited in a list of proposed policies and actions that aim to concentrate growth and protect agricultural lands from conversion to non-agricultural use.</p> <p>As indicated on page 4.2-12 of the Draft EIR, because the farmlands that could be converted to urban uses are located near existing urbanized areas, they may not be viable for agricultural operations due to conflicts with nearby urbanized areas. The impact could be avoided by prohibiting development; however, to do so would be to change the project. See the response to Comment A09-3 regarding changing the land use map to avoid impacts, as well as regarding a mitigation measure that has been added requiring participation in the City’s agricultural conservation program for projects that would convert farmlands of concern under CEQA.</p> <p>See the response to Comment A09-4 regarding policies to mitigate agricultural impacts that were suggested by the Delta Protection Commission. See also the responses to Comments A13-24 and A13-26 regarding other mitigation suggestions from this commenter. The comment offers no other mitigation recommendations.</p> |

## COMMENTS AND RESPONSES

| Comment # | Date | Comment   | Response  |
|-----------|------|---|---|
|           |      | <p>agricultural land of this magnitude. It is well understood that requiring agricultural conservation at a 1:1 ratio does not “fully mitigate farmland conversion, since a 1:1 ratio is only adequate to protect half of the existing farmland base in [the] county.” Building Industry Assn. v. County of Stanislaus (2010) 190 Cal.App.4th 582, 591-92. In other words, if the County loses one acre of farmland but then mitigates that loss by preserving a second acre of existing farmland, it has still lost 50 percent of the original farming acreage—it started with two acres and now has only one. Because General Plan Action LU-5.3.C will thus not fully offset the loss of farmland caused by the Project, the DEIR correctly concludes that the Project’s farmland impacts remain significant. See Citizens for Open Government v. City of Lodi (2012) 205 Cal.App.4th 296, 322 (finding conversion of 40 acres of farmland a significant impact even after purchase of conservation easements at a 1:1 ratio). However, the DEIR stops short of requiring additional mitigation to reduce impacts further. A revised EIR must identify additional mitigation to address this impact.</p> |   |
| A13-24    |      | <p>In addition, although the proposed General Plan states that “local agricultural lands provide needed buffers between Stockton and neighboring cities” (Envision Stockton 2040 General Plan at 3-20), neither the Plan nor the DEIR adequately address the need for an agricultural buffer between Stockton and surrounding cities. The draft General Plan includes Action LU-5.3B, which provides that the City will “[C]oordinate with San Joaquin County to develop a plan for a greenbelt or community separator around the city.” However, the proposed General Plan provides no details as to what such a greenbelt plan would entail or how it would be implemented.</p>   | <p>While proposed Action LU-5.3B would generally support the preservation of agricultural resources within the region by establishing a greenbelt or community separator around the city, it is not intended as mitigation for, nor does it mitigate, impacts on agricultural resources. The same acreage of farmlands of concern under CEQA could still be converted to non-agricultural uses and the same acreage of land under active Williamson Act contracts would still be designated for a conflicting use with or without an agricultural buffer between Stockton and surrounding cities. Therefore, performance standards and other details requested in the comment are not required by CEQA. See Master Response #1, Project Merits, located in Section 5.1 of this chapter.</p> <p>In addition, the proposed General Plan preserves significant agricultural resources around the city by redesignating approximately 9,000 acres from urban designations to Open Space/Agriculture. That land is under the jurisdiction of San Joaquin County, which designates the majority of the area outside the SOIs of cities for agricultural purposes and maintains a corresponding agricultural zoning designation. Therefore, agricultural lands and open space in those areas surrounding the city would be maintained, fundamentally providing an agricultural buffer between Stockton and surrounding cities, such as Lodi.</p> <p>In addition, see the response to Comment A09-4 regarding the use of buffers as mitigation for impacts to agricultural resources.</p> |
| A13-25    |      | <p>Given the importance of agricultural lands, and the proposed Plan’s significant impacts on a substantial amount of farmland, the DEIR should have included a more robust analysis that included specific mitigations.</p>  | <p>See the responses to Comments A13-23 and A13-24.</p>   |

## COMMENTS AND RESPONSES

| Comment # | Date | Comment   | Response   |
|-----------|------|---|--|
|           |      | Instead, the DEIR concludes that impacts to agricultural lands would be significant but fails to identify any additional policies or implementation actions describing concrete regulations and/or incentives to preserve agricultural land buffers.  |  |
| A13-26    |      | A mitigation measure should be added that requires the City, in concert with the County, the City of Lodi, the Central Valley Farmland Trust, residents and affected landowners, to prepare an Agricultural Buffer Action Plan that addresses, among other items, how to target the fees that are collected by the two cities and the County toward purchasing easements within the defined buffer area. The general location of the Agricultural Buffer Area should also be identified on the Plan Land Use Diagram map.   | <p>As described in the response to Comment A13-23, the City manages an existing agricultural conservation program that offers a mitigation option to pay an in-lieu fee for development that would convert farmlands of concern under CEQA to urban uses. Such fees are transmitted to the Central Valley Farmland Trust to fund the conservation of agricultural resources in the region. Resolution 07-0080 of the Stockton City Council, which established the program, specifies that agricultural lands to be conserved using mitigation funds must be located within the "Central Zone" of San Joaquin County, as defined in the San Joaquin County Multi-Species Habitat Conservation and Open Space Plan, which includes Stockton and its surrounding area. Therefore, agricultural mitigation fees are already used for local conservation efforts.</p> <p>In addition, as explained in the response to Comment A13-24, an agricultural buffer around the city would not reduce the acreage of farmlands of concern under CEQA that could be converted to a non-agricultural use nor reduce the acreage of land under active Williamson Act contracts that would be designated for a conflicting use, so it would not mitigate the impact.</p> <p>Finally, the lands that are intended to remain open for agricultural purposes are denoted on the proposed General Plan land use map through the Open Space/Agriculture designation.</p> |
| A13-27    |      | As have noted elsewhere, we remind the City and consultant that CEQA requires that all feasible measures be identified that would reduce impacts, even if the final result would be "significant and unavoidable."  | The comment is noted. Please see the responses to Comments A09-4, A13-23, A13-24, and A13-26 regarding mitigation for agricultural resource impacts.   |
| A13-28    |      | <p><b>The DEIR Fails to Evaluate Potential Impacts and Propose Feasible Mitigation Measures to Reduce the Plan's Significant Impacts Related to Transportation.</b></p> <p>A layperson reading the DEIR who was concerned about the potential traffic impacts related major growth planned north of Eight Mile Road might logically ask "Would a new interchange on I-5 be required to serve that growth?" However, there is no discussion or analysis, much less mitigation required for this planned growth. The section notes that "Because the proposed General Plan scales back land use development assumptions through 2040, some of the roadway network improvements to support previously planned development, such as development north of Eight Mile Road, were not included in the proposed General Plan network". DEIR at 4.14-26.</p> | See the response to Comment A13-19.  |

## COMMENTS AND RESPONSES

| Comment # | Date | Comment  | Response  |
|-----------|------|--|---|
| A13-29    |      | Similarly, there is no discussion of transportation impacts related to the construction of the largest of the “approved” projects such as Mariposa Lakes, which would directly contribute to gridlock conditions on State Route 99, and the Sanctuary/Westlake Villages/Delta Coves projects, which will affect I-5. The transportation analysis in the DEIR is remiss in failing to summarize the mitigation requirements that were included in the certified EIRs, development agreement, and/or conditions of approval for these projects.  | The transportation analysis presented in the Draft EIR included the approved amount of development from the Sanctuary, Westlake Villages, Delta Cove, Tidewater Crossings, and other projects approved as of the issuance of the Notice of Preparation. The analysis also considered the roadway network improvements that would be built as part of those projects, and the mitigation measures that are required to be constructed as part of the project. The mitigation requirements for each of these projects are summarized in the various approval documents, as available on the City's website:<br><a href="http://www.stocktonca.gov/government/departments/communityDevelop/cdPlanEnv.html">http://www.stocktonca.gov/government/departments/communityDevelop/cdPlanEnv.html</a>  |
| A13-30    |      | We are disappointed that the entire analysis fails to offer any mitigation measures to address funding of new transportation improvements that are needed to serve the growth, or how projects will contribute their fair share of the cost.   | Development within the city is subject to the payment of local and regional transportation impact fees to fund the construction of roadway facilities required to support proposed development. These fees are periodically updated to reflect changes to the overall project list within the fee program. Pursuant to proposed Action LU-6.5C, all fees, including Street Improvements, will be updated to be consistent with the 2040 General Plan. For some improvements, impact fees may not cover the entire improvement cost, and other funding sources would be sought by the City, including State and federal funds, Measure K funds, and other grant programs.  |
| A13-31    |      | <p>The mitigation measures that are recommended are inadequate and in some cases fail to address the impacts that have been identified. For example, Impact TRAF-1 states “Implementation of the proposed General Plan, in combination with regional growth, would result in increased vehicle traffic, which would affect the operation of local roadways and freeway segments. As shown in Table 4.14-2 and discussed above, the proposed General Plan would result in significant level-of-service impacts to roadway and freeway segments.”</p> <p>Mitigation Measure TRAF-1a requires the City to conduct focused complete streets or engineering studies but fails to explain how the required improvements would be funded. The DEIR concludes that the impacts on local streets would be “Significant and unavoidable. While implementation of Mitigation Measure TRAF-1a would retain right-of-way to provide wider cross-sections than are envisioned under the proposed General Plan subsequent to detailed evaluation, parallel capacity and/or additional right-of-way is not available to mitigate some impacts, and the City cannot guarantee that funding would be available to conduct additional evaluations and construct identified improvements.” This constitutes a gross failure to protect the existing and future residents from unacceptable traffic congestion resulting from new growth. The City has an existing traffic mitigation fee program. Will there be enough money collected in the future to pay for these improvements or not?</p> | <p>A variety of funding sources would be used to conduct focused complete street and/or engineering studies, including transportation impact fees to which new development would contribute; such impact fees would also be used to construct future roadway improvements, as described in the response to Comment A13-30. New developments would be required to pay their fair share, but it is not guaranteed that the fee program would collect sufficient revenues to cover all improvement costs, and may need to be leveraged against other funding sources. The ultimate fee level assessed to new development will need to balance the total development burden so as to not discourage new development within the city or increase the cost of housing to unaffordable levels. Large development projects are also required to prepare a fiscal impact analysis, as specified in proposed General Plan Action LU-6.5A, "to ensure a full accounting of infrastructure and public service costs and to confirm whether revenue enhancement mechanisms are necessary to ensure net fiscal balance or better, and require appropriate fiscal mitigations, when necessary, to ensure the City’s ongoing fiscal health and continued viability of the City’s General Fund."</p> <p>Potential roadway impacts were ultimately deemed to be significant and unavoidable because the City cannot assume implementation of roadway improvements within a specific timeframe given the uncertainties of federal, State, and local funding sources. For example, if Senate Bill (SB) 1 (California State Wide Gas Tax) is repealed in November (Proposition 6), a key funding source for regional and local roadway maintenance, transit agency funding, and bicycle and pedestrian projects would be eliminated. Within Stockton, SB 1 funding is currently being used to repair 30 lane-miles of State Route (SR)</p> |

**COMMENTS AND RESPONSES**

| Comment # | Date | Comment  | Response  |
|-----------|------|--|---|
| A13-32    |      | <p>Likewise, Mitigation Measure TRAF -1b states the following: "The City shall implement the following to reduce the severity of potential LOS impacts on the following freeway segment: State Route 99 between Farmington Road and Fremont Street. The Cumulative with Proposed Plan transportation analysis considers the widening of State Route 99 through Stockton to its ultimate planned width. No additional improvements have been identified. Implementation of the proposed General Plan and its associated policies are expected to provide alternative travel choices to Stockton residents and workers, shifting travel patterns and modes. However, deficient operations are expected to occur on State Route 99, and this impact would remain significant and unavoidable. Significance With Mitigation: Significant and unavoidable."</p> <p>The DEIR analysis fails to consider how required contributions from major development in the area (Mariposa Lakes and industrial projects near the airport) could fund roadway improvements, including transit, ridesharing and other programs to reduce the impacts of a gridlocked freeway segment. CEQA requires that all feasible measures be identified that would reduce impacts, even if the final result would be "significant and unavoidable." A revised DEIR should include an analysis of potential programs that could address the freeway congestion and reduce trips.</p> | <p>99 from SR 4 to Hammer Lane, as well as repair 83 lane-miles on Interstate 5 from Hammer Lane to the San Joaquin/Sacramento County line. For local streets, the City has requested funding for street-resurfacing, installation of pedestrian safety treatments, repairing vandalized street lights, and implementing a neighborhood traffic management program. In addition to funding roadway repairs, SB 1 funds are currently being used for maintenance of San Joaquin Regional Transit District (SJRTD) facilities in Downtown Stockton, as well as to fund on-going transit operations. Should this funding source be eliminated, delivery of capacity-enhancing projects will become increasingly difficult given limited funding sources.</p>   |
| A13-33    |      | <p>As noted below under the "Settlement Agreement" discussion, we strongly disagree with the conclusion in Impact TRAF-6 that "Implementation of the proposed Plan would not conflict with adopted policies, plans, or programs regarding public transit, bicycle, or pedestrian facilities, or otherwise decrease the performance or safety of such facilities." DEIR at 4.14-26. The Plan policies and actions that are cited as addressing these issues are vague and unimplementable. Action TR-2.3.B states "Obtain input from local and regional transit operators on major new development projects to ensure new projects are designed to support transit and provide adequate transit service and access." "Obtaining input" is vague and normally occurs as part</p>   | <p>See the responses to Comments A13-29 and A13-31.</p> <p>Development of approved projects, such as the Mariposa Lakes project, is bound by the conditions of approval established at the time of project approvals; the proposed General Plan cannot change the conditions of approval for those approved projects. Additionally, proposed General Plan policies and actions to reduce vehicle trips, including through the preparation of transportation demand management programs by major employers (Policy SAF-4.2), requirements that new development incorporate design features to provide safe and comfortable access to transit (Action TR-2.2A), and implementation of the City of Stockton Bicycle Master Plan (Action TR-2.1B), among other policies and actions, were all considered in the evaluation of mitigation measures. However, the effectiveness of these measures cannot be quantified to a level that could show a reduction in the severity of the impact to a less-than-significant level.</p> <p>New development would be required to support transit through clear, enforceable actions, including proposed Action TR-2.2A, which states: "Require major new development to incorporate design features to promote safe and comfortable access to transit, such as a circulation network that facilitates efficient and connected bus travel, clear pedestrian and bicycle routes connecting origins and destinations to transit stops, sheltered bus stops, park-and-ride facilities, and highly visible transit information and maps." Additionally, fiscal impact analyses would be required for large projects to determine "whether revenue enhancement mechanisms are necessary to ensure net fiscal balance or better, and require appropriate fiscal mitigations, when necessary, to ensure the City's ongoing fiscal health and continued viability of the City's General Fund"</p> |

## COMMENTS AND RESPONSES

| Comment # | Date | Comment  | Response  |
|-----------|------|--|---|
|           |      | of the review process. The Actions and the Policy TR-2.2 must be re-written to specifically require that major new projects may not be approved unless the plans include facilities and a funding mechanism to pay for transit connections and address shortfalls in transit operating funds that have been identified in the Transit Gap Analysis, to ensure the new project pays the full cost for the transit connection needed.  | (proposed Action LU-6.5A). Fiscal mitigations could include contributions to on-going transit service in the project area. Such actions, along with the policies and actions listed on pages 4.14-38 and 4.14-39 of the Draft EIR, would support, and not conflict with, policies, plans, and programs regarding public transit, including the Transit Gap Study. See also the response to Comment A13-34.  |
| A13-34    |      | We are incredulous that there is no discussion and analysis of the Transit Gap Analysis in the entire transportation section (Transit Gap Study, January 2010). It is as if the City and consultant want to ignore the study, which was required as part of the Settlement Agreement. Please include such a discussion and analyze whether the Plan impacts rectify or worsen the “gaps” identified in the study.  | In response to this comment, a discussion about consistency with the transit gap study has been added to page 4.14-39 of the Draft EIR, as shown in Chapter 3 of this Final EIR. Although the transit gap study is not referenced in the proposed General Plan, there are a number of policies and actions that are supportive of transit and help to further reduce the transit gap. As shown in the Draft EIR text edits in Chapter 3 of this Final EIR, implementation of the proposed General Plan would not worsen the gaps identified in the study, and will instead help to further close the remaining gaps.  |
| A13-35    |      | Finally, the San Joaquin Council of Governments Regional Transportation Plan/Sustainable Communities Strategy (RTP/SCS) update was adopted on June 28, 2018. The current DEIR analysis of the consistency of the Plan was based on the 2014 RTP/SCS. The DEIR must be revised so that the analysis is based on the most recent RTP/SCS.  | The analysis in the Draft EIR was based on the environmental setting at the time that the Notice of Preparation was published, which was in 2017. SJCOG is the lead agency responsible for the Regional Transportation Plan/Sustainable Communities Strategy (RTP/SCS). In its June 22, 2017 letter in response to the Notice of Preparation, SJCOG directed the City to show consistency with the 2014 RTP/SCS, which the City did on pages 4.7-43, 4.10-18 to 4.10-20, and 4.14-38 to 4.14-39 of the Draft EIR. Furthermore, SJCOG’s August 10, 2018 letter on the Draft EIR did not request that the City update its analysis of consistency with the 2018 RTP/SCS, nor did it indicate that the proposed project is inconsistent with the RTP/SCS.  |
| A13-36    |      | <p><b>The DEIR Fails to Adequately Analyze and Mitigate for the General Plan’s Greenhouse Gas Emissions.</b></p> <p>The DEIR concludes that the Project’s impacts from GHG emissions are significant because the Project conflicts with the goal of Executive Order S-03-05 to reduce GHG emissions by 80% below 1990 levels by 2050. DEIR at 4.7-27. Yet the DEIR fails to actually disclose the extent of the impact, as required by CEQA.</p> <p>An agency’s rote acknowledgement that impacts are “significant” does not cure an EIR’s failure to analyze the issue. As the court stated in <i>Galante Vineyards v. Monterey Peninsula Water Management Dist.</i>, 60 Cal. App. 4th 1109 (1997), “this acknowledgment is inadequate. ‘An EIR should be prepared with a sufficient degree of analysis to provide decisionmakers with information which enables them to make a decision which intelligently takes account of environmental consequences . . . .’” <i>Id.</i> at 1123 (quoting <i>Santiago County Water Dist. v. County of Orange</i>, 118 Cal. App. 3d 818, 831 (1981)); see also <i>Mira Monte Homeowners Assn. v. County of Ventura</i>, 165 Cal. App. 3d 357, 365 (1985) (an EIR is meant to protect “the right of the public to be</p> | Under Impact GHG-1, Table 4.7-7 on page 4.7-29 of the Draft EIR shows the derived 2040 and 2050 efficiency targets based on the adopted year 2030 GHG reduction target established under SB 32 and the year 2050 GHG reduction goal set under EO S-03-05. As shown in the table, the proposed project would not meet the forecasted 2040 efficiency metric. In order to meet the 2040 efficiency metric and show progress toward meeting the 2050 GHG reduction goal, the proposed project would need to achieve an efficiency of 2.61 metric tons of carbon dioxide equivalent (MTCO <sub>2e</sub> ) per year per service population (MTCO <sub>2e</sub> /yr/SP). Based on this comment, Impact GHG-1 has been updated to clarify that, based on the forecasted 2040 efficiency metric of 2.61 MTCO <sub>2e</sub> /yr/SP and the projected service population of 597,200 persons in horizon year 2040, the City’s total 2040 community emissions would need to be less than 1,558,692 MTCO <sub>2e</sub> /yr to show progress in meeting the 2050 GHG reduction goal. This change is reflected in Chapter 3 of this Final EIR. |



**COMMENTS AND RESPONSES**

| Comment # | Date | Comment   | Response   |
|-----------|------|---|--|
|           |      | <p>informed in such a way that it can intelligently weigh the environmental consequences of a[] contemplated action.”). Thus, an agency may not, as the City attempts to do here, “travel the legally impermissible easy road to CEQA compliance . . . [by] simply labeling the effect ‘significant’ without accompanying analysis . . .” <i>Berkeley Keep Jets Over the Bay Committee v. Board of Port Commissioners</i>, 91 Cal. App. 4th 1344 1371, 2001.</p> <p>This is precisely what the DEIR does in regard to its conclusion that the Project’s noncompliance with Executive Order S-03-05 is a significant impact. DEIR at 4.7-30. The DEIR calculates the GHG emissions in 2040 under the proposed General Plan and concedes that the proposed General Plan would result not only in exceedance of the bright-line threshold of significance for GHG emissions, but it would also fail to achieve Plan-level thresholds of significance for both 2040 and 2050. DEIR at 4.7-28 and 4.7-29 -30. DEIR at 4.7-29. However, it fails to identify the level the GHG emissions need to be in 2040 to be on track to meet the 2050 goal set by the executive order. Thus, the EIR fails to disclose to what extent the GHG emissions under the General Plan will fail to meet the target emissions. Accordingly, under CEQA, “a more detailed analysis of how adverse the impact will be is required.” <i>Galante Vineyards</i>, 60 Cal. App. 4th at 1123.</p> |  |
| A13-37    |      | <p>The DEIR further fails to meet the requirements of CEQA because it fails to identify any mitigation measures to lessen the Plan’s significant increase in emissions and its noncompliance with Executive Order S-03-05. Instead, the DEIR concludes that “Mitigation Measure GHG-1 would reduce GHG emissions to the extent feasible” and that no additional mitigation is available. DEIR at 4.7-31. To the contrary, the most effective mitigation measure for most of the General Plan’s impacts, including climate impacts, is to modify the land use diagram and land use designations to discourage sprawl, to increase the density of residential uses, and to increase mixed-use residential and commercial areas that are designed to be walkable and to be near mass transit systems.</p>  | <p>Overall, when compared to the existing 2035 General Plan, the proposed 2040 General Plan is generally more consistent with the land use principles noted in the comment. Under the proposed 2040 General Plan, development would be shifted from the city periphery to the city core and there would be more of a focus on creating walkable mixed-used corridors. Please see Section 3.4.4, <i>Major Changes from the Existing General Plan</i>, on pages 3-17 to 3-19 of the Draft EIR for further details on the changes under the proposed 2040 General Plan Update compared to the existing General Plan, including changing approximately 9,000 acres from an urban designation to Open Space/Agriculture at the edge of the city, increasing the allowed residential density within the Downtown Core and Greater Downtown, and establishing residential density minimums throughout the city. Also of note, the proposed General Plan had to also account for development projects at the city periphery that had already been previously approved or are pending. These already approved and pending projects account for a large portion of criteria air pollutant and GHG emissions calculated for the proposed General Plan.</p> <p>Inclusion of a mitigation measure that would change the land use types, mix, and land use designations would inherently change the land use plan of the proposed project and would be considered an alternative to the proposed project. In general, the City, as the lead agency, has leeway in determining a land use plan that would best meet or attain</p> |

## COMMENTS AND RESPONSES

| Comment # | Date  | Comment  | Response   |
|-----------|---|--|--|
| A13-38    | In addition, of the measures the DEIR does include to address GHG impacts, several are vague, incomplete, insubstantial, and nonbinding, and thus | <p>the objectives of a project. However, although the City as the lead agency may devise a project in a way that best meets the project objectives, per Public Resources Code (PRC) Section 21081 and CEQA Guidelines Section 15093, whenever significant environmental effects cannot be mitigated to a less-than-significant level, the lead agency is required to balance the benefits of the proposed project against its unavoidable significant environmental impacts when determining whether to approve a project. Specifically, under CEQA Guidelines Section 15093(a), “CEQA requires the decision-making agency to balance, as applicable, the economic, legal, social, technological, or other benefits, including region-wide or statewide environmental benefits, of a proposed project against its unavoidable environmental risks when determining whether to approve the project.” If a lead agency determines that the economic, legal, social, and other benefits outweigh the identified unavoidable environmental risks, it must prepare a statement of overriding considerations to support this decision per CEQA Guidelines Section 15093(b). If the City determines that the benefits of the project, as proposed, outweigh the identified unavoidable significant environmental impacts, a statement of overriding consideration will be prepared pursuant to the requirement of CEQA Guidelines Section 15093(b). CEQA Guidelines Section 15093 addresses and acknowledges the balancing of competing public objectives.</p> <p>In addition to the requirements of PRC 21081 and CEQA Guidelines Section 15093, per CEQA Guidelines Section 15126.6, an EIR must also provide a range of reasonable alternatives to the proposed project that can avoid or substantially reduce significant effects of a project. Per this requirement, the Draft EIR included alternatives in Chapter 5, <i>Alternatives to the Proposed Project</i>. The alternatives analyzed include the No Project, Corridors Focus, and Infill Focus alternatives. As described in Section 5.3, <i>Infill Focus Alternative</i>, on pages 5-20 to 5-27 of the Draft EIR, the land use plan under the Infill Focus Alternative would be similar to that of the proposed General Plan, but it would eliminate the Economic and Education Enterprise designation in the area north of Eight Mile Road, replacing it instead with an open space and agriculture designation. Additionally, this alternative would provide for more professional office uses along South Airport Way and high density residential near Weston Ranch in the southwestern portion of the city. As discussed on pages 5-23 and 5-25 of the Draft EIR, the Infill Focus Alternative would reduce air quality and GHG impacts compared to the proposed General Plan. Furthermore, as discussed on page 5-27 of the Draft EIR, this alternative would be the environmentally superior alternative given its reduced impacts with respect to several environmental topics, including air quality and GHG emissions.</p> | <p>Please also see Master Response #3, Mitigation, in Section 5.1 of this chapter.</p> <p>Mitigation Measure GHG-1 is specific and enforceable. This mitigation measure requires that the City update its Climate Action Plan (CAP) to meet the 2030 target established by</p> |

**COMMENTS AND RESPONSES**

| Comment # | Date | Comment  | Response   |
|-----------|------|--|--|
|           |      | cannot be relied on to mitigate Project impacts. For example, Mitigation Measure GHG-1 directing the City to update the City’s Climate Action Plan (“CAP”) specifies that targets and strategies in the CAP would only be required to 2030. DEIR at 4.7-30. This approach is unlawful.   | SB 32, proceeding to adoption hearings within 24 months of adoption of the proposed General Plan. The mitigation measure includes a specific performance standard for the City to achieve that is tied to the 2017 Scoping Plan target framework. The requirement to update the CAP for year 2030 coincides with the GHG emissions target established under SB 32 as there are currently no plans beyond year 2030 that have been adopted to meet the long-term 2050 reduction goal set by Executive Order S-03-05. Pursuant to CEQA case law, where the agency has evaluated significant impacts and identified measures that will mitigate them, it doesn’t have to commit to any particular identified mitigation measure as long as it commits to mitigate the impacts. The CEQA Guidelines state that mitigation measures may specify performance standards for mitigating a significant impact (Section 15126.4(a)(1)(B)). Mitigation Measure GHG-1 is not unlawful deferral because it sets a specific timeframe to update the City’s CAP within 24 months and establishes a performance target in line with the GHG reduction target for 2030 established under SB 32. The proposed General Plan is a policy plan, which includes broad-based goals and policies for the City. Therefore, the details on how the City can achieve the GHG reduction goals of SB 32 are best established in a CAP that includes specific action measures and programs for new development and existing development. Measures in the City’s CAP may change based on available technology and State measures that provide a top-down approach to achieving the statewide GHG targets (e.g., Senate Bill 100). |
| A13-39    |      | Moreover, because the General Plan will be in effect until 2040, the DEIR must analyze the impacts of full-buildout from the plan out to 2040.   | See Master Response #2, Development Projections, in Section 5.1 of this Chapter.   |
| A13-40    |      | Second, Mitigation Measure GHG-1 includes a list of measures that may be included in the CAP. But once again the DEIR states only that the “City shall consider” the measures rendering the measures unenforceable. DEIR at 4.7-30; emphasis added.  | As stated in the response to Comment A13-39, an agency may defer committing to specific mitigation measures when it approves a project if the measures that will be considered subsequently are described and performance criteria are identified. In <i>Defend the Bay v City of Irvine (2004) 119 CA4th 1261</i> , the court held that an agency may defer defining the specifics of mitigation measures if it "commits itself to mitigation and lists the alternatives to be considered, analyzed, and possibly incorporated in the mitigation plan." The measures identified in Mitigation Measure GHG-1 are measures the City must consider when updating the CAP; however, the City is not limited to these measures. The CAP may include these measures and additional measures to achieve the City’s 2030 GHG target. Per Mitigation Measure GHG-1, the updated CAP would be required to identify measures that achieve the 2030 GHG emissions reduction target as established under SB 32.  |
| A13-41    |      | M-GHG-1 also proposes that the City ‘consider’ establishing goals for 15 percent of existing development to install solar panels over carports and to power five percent residential and 10 percent of non-residential development with solar energy. Id. But the DEIR provides no explanation of why these percentages are appropriate or whether greater reductions are infeasible. DEIR at 4.7-30 and 31. | These solar energy goals outlined in Mitigation Measure GHG-1 are from the 2014 City of Stockton CAP (Measures Energy-5 and Energy-6) and are included as possible measures to include in the updated CAP. If necessary, the specific solar energy goals can be determined during the CAP Update process, as that process would better determine what specific measures are needed for the City to be consistent with the 2030 GHG reduction target established under SB 32. Please refer to the response to Comment A13-  |

## COMMENTS AND RESPONSES

| Comment # | Date | Comment   | Response   |
|-----------|------|---|--|
| A13-42    |      | Measures relied upon to mitigate impacts must be “fully enforceable” through permit conditions, agreements, or other legally binding instruments. Pub. Res. Code § 21081.6(b); CEQA Guidelines §15126.4(a)(2). Similarly, the mitigation must provide assurance that it will be implemented, and not merely adopted and then disregarded. <i>Anderson First Coalition v. City of Anderson</i> (2005) 130 Cal. App. 4th 1173, 1186-87; <i>Fed’n of Hillside &amp; Canyon Assn’s v. City of Los Angeles</i> (2000) 83 Cal. App. 4th 1252, 1261. M-GHG-1 is neither and is insufficient without substantial evidence that further mitigation is infeasible.  | 40 regarding the primary purpose of Mitigation Measure GHG-1 and the requirements it prescribes.<br>Mitigation Measure GHG-1 would require that the City create a planning framework in implementing the requirements and goals of the updated City of Stockton CAP. It would also require that the City monitor the progress in implementation of the updated CAP and that a community inventory be prepared every five years. Furthermore, the City would also be required to develop a CAP for post-2030. Mitigation Measure GHG-1 binds the City to updating its CAP within 24 months of adoption to outline a plan to achieve the GHG reduction goals of SB 32 by 2030. As stated in the response to Comments A13-39 and A13-40, an agency may defer committing to specific mitigation measures when it approves a project if the measures that will be considered subsequently are described and performance criteria are identified. Mitigation Measure GHG-1 meets these criteria.   |
| A13-43    |      | In summary, the vague, voluntary, and unenforceable policies cited as mitigation measures in the DEIR fail to comply with CEQA, which requires enforceable, concrete commitments to mitigation. As a result, the DEIR completely fails to describe measures that could avoid or substantially lessen the General Plan’s numerous significant impacts. These inadequacies require that the DEIR be revised and recirculated so that the public and decision-makers are provided with a proper analysis of the proposed General Plan’s significant environmental impacts and feasible mitigation for those impacts. See CEQA Guidelines § 15002(a)(1) (listing as one of the “basic purposes” of CEQA to “[i]nform governmental decision makers and the public about the potential, significant environmental effects of proposed activities”).   | See the responses to Comments A13-37, A13-38, and A13-40 through A13-42, as well as Master Responses #3, Mitigation, and #4, Draft EIR Revisions and Recirculation, in Section 5.1 of this Chapter.  |
| A13-44    |      | <b>The Draft General Plan Policies are Not Consistent with the Settlement Agreement</b><br>The greenhouse gas section of the DEIR inaccurately describes the consistency of the proposed General Plan with the terms of the Settlement Agreement signed between the City, the Sierra Club, and the State Attorney General’s office, and concludes the following:<br><br>The proposed General Plan limits the opportunity for new development in the SOI (i.e., outside the city limit) mainly to what has already been approved. While the EIR evaluates growth from existing conditions that includes an increase in emissions from approved and pending projects outside the city limit, the proposed General Plan focuses new growth in Greater Downtown Stockton and the city limit. As identified in the table, overall, the proposed General Plan includes and/or considered the mandatory measures listed in the Settlement Agreement. Additionally, Mitigation Measure GHG-1 ensures that updates to the measures are | As explained in Master Response #2, Development Projections, in Section 5.1 of this Draft EIR, the full buildout projections reported in Table 3-3 on page 3-26 of the Draft EIR represent the maximum theoretical buildout that could occur if the entire EIR Study Area were developed to its maximum capacity. They are not realistic projections of future development, cannot occur without additional environmental review (pursuant to Action LU-6.1A), and are provided for information disclosure purposes, in part to elaborate the City’s methodology for projecting the 2040 horizon year development that was analyzed in the Draft EIR.<br><br>When evaluating consistency with the 2008 Settlement Agreement, it is important to consider the context of that Settlement Agreement—namely, the adopted 2035 General Plan. The Settlement Agreement was established in response to the 2035 General Plan. When considering the proposed 2040 General Plan within the context of the adopted 2035 General Plan, i.e., the reason the Agreement was established, the proposed General Plan land use map represents a significant limitation on new development outside the city limit by changing the designation on approximately 9,000 acres from an |

**COMMENTS AND RESPONSES**

| Comment # | Date | Comment  | Response   |
|-----------|------|--|--|
|           |      | <p>considered in the update to the CAP. Therefore, the proposed project would not conflict with the mandatory stipulations in the 2008 Settlement Agreement and the impact is considered less than significant. (DEIR at 4.7-32)</p> <p>This paragraph mischaracterizes the amount and location of growth that is allowed by the Plan. The statement that the Plan “limits the opportunity for new development in the SOI (i.e., outside the city limit) mainly to what has already been approved” is not accurate, since the Plan would allow over 26,000 housing units north of Eight Mile Road, which is within the Sphere but is not an “approved” project.”</p> <p>Likewise, the claim that “the proposed General Plan focuses new growth in Greater Downtown Stockton and the city limit” is not supported by the evidence presented in the Project Description chapter of the DEIR. The text and Tables 3-2, 3-3, and 3-4 clearly identify where the amount of “new” growth allowed by the updated Plan is “focused,” and less than one-third (31%) of the new growth, excluding the development projects that were already approved under the previous Plan, is in the downtown or the existing neighborhoods.</p> <p>Out of the 40,900 housing units projected under the Plan by 2040, about 14% (5,620 units) of the growth may occur in the downtown, 17% (7,880 units) is assumed as infill growth in the existing neighborhoods outside of the downtown, 40% (16,400 units) consists of already approved projects at the periphery of the city limits, and the remaining 29% (11,800 units) is assumed in the projects outside the city limits.</p> <p>The additional housing growth that is allowed by the Plan, but which is not assumed by 2040, amounts to 78,800 housing units (including 26,000 units north of Eight Mile Road), with more than three-quarters of that growth occurring outside of the downtown and existing neighborhoods.</p> | <p>urban designation to Open Space/Agriculture, and it represents a significant increase in the opportunity for new development within the Downtown Core and Greater Downtown by dramatically increasing the allowed density of development in those areas.</p> <p>Furthermore, in Table 4.7-8 on page 4.7-35, the Draft EIR identifies the projected 2040 development under the proposed General Plan within the boundaries identified in the Settlement Agreement, i.e., the Greater Downtown and city limit as it existed in 2008. The table specifies that the 2040 projection includes over 7,600 units in the Greater Downtown and over 21,000 units in the 2008 city limit, which are significantly more units than called for in the Settlement Agreement within those boundaries (i.e., 4,400 units and an additional 14,000 units, respectively). Full buildout in those areas would include even more units.</p> <p>This means that, out of the 40,900 units projected by 2040, almost 20 percent is projected to occur within the Greater Downtown, and over 50 percent is projected to occur within the 2008 city limit. Therefore, less than half of the projected 2040 development would occur outside the 2008 city limit. Much of that development outside of the 2008 city limit that is included in the 2040 development projection is due to approved and pending projects over which the proposed General Plan has no control.</p> <p>Finally, consistency with the Settlement Agreement cannot be determined solely by the proposed land use map without considering the proposed project's policies and actions. The consistency review with the Settlement Agreement presented in Table 4.7-8 on pages 4.7-33 through 4.7-37 of the Draft EIR clearly outlines how the proposed policies and actions support, and do not conflict with the Settlement Agreement.</p> |
| A13-45    |      | <p>Table 4.7-8 notes that “The Agreement requires consideration of the following amendments to the General Plan to ensure that development on the city’s outskirts does not grow in a manner that is out of balance with development of infill. The Agreement does not require actual City Council adoption of such policies or programs. Amendments shall include measures limiting the granting of entitlements for certain development projects outside the city limit until certain criteria are met:</p>  | <p>The area designated Economic and Education Enterprise on the proposed land use map is currently designated for urban development through the Village and Low Density Residential designations in the existing 2035 General Plan (see Figure 4.10-5 on page 4.10-10 of the Draft EIR). Therefore, the City does not agree that this designation is “a very significant amendment to the existing General Plan” with respect to the Settlement Agreement.</p> <p>See pages 4.7-36 to 4.7-37 of the Draft EIR for a summary of proposed General Plan</p>   |

## COMMENTS AND RESPONSES

| Comment # | Date | Comment   | Response  |
|-----------|------|---|---|
|           |      | <p>(a) Urban Performance Measures. Minimum levels of transportation efficiency, transit availability, and level of service; City service capacity; water availability; and other urban services performance measures.”</p> <p>The designation of 3,800 acres of agricultural land north of Eight Mile Road for urban development of ““Economic and Education Enterprise” land uses as a key component of this updated Plan (which constitutes a very significant amendment to the existing General Plan) is grossly inconsistent with this requirement of the Settlement Agreement. The Plan includes no policies that specify “Minimum levels of transportation efficiency, transit availability, and level of service; City service capacity; water availability; and other urban services performance measures” for this project. In fact, the Plan and this DEIR are virtually silent on the transportation improvements that would be required to serve this growth, as well as whether the City could provide efficient transit service, water supply, and other urban services. The table concludes that Actions LU-6.1.B through LU-6.1.G of the Plan would address these specifications but they do not.</p> | <p>policies and actions that would establish minimum levels of services and infrastructure for all projects (including projects proposed within the Economic and Education Enterprise designation), including proposed Actions LU-6.1B through LU-6.1G that ensure new growth can be supported by essential public services and infrastructure, and Policies TR-4.1 through TR-4.3 and their associated actions that maintain roadway levels of service and reduce VMT per capita. In addition, Action LU-6.2B directs the City to not approve future annexations or City utility connections unless they are consistent with the overall goals and policies of the General Plan and do not adversely impact the City’s fiscal viability, environmental resources, infrastructure and services, and quality of life, and Action LU6.3A requires development to mitigate any impacts to existing sewer, water, stormwater, street, fire station, park, or library infrastructure that would reduce service levels.</p> <p>See also the response to Comment A13-19, which clarifies that if development is proposed in the Economic and Education Enterprise designation, additional detailed land use and transportation planning would be required to identify the roadway network and transportation improvements needed to support development in that area. However, no development is currently proposed within the area.</p> |
| A13-46    |      | <p>Another example of the inconsistency between the Settlement Agreement and the Plan is the requirement “that housing or development projects subject to a Specific Plan/Master Development Plan or regionally significant projects provide financial and/or other support for transit use. Fees are required to cover the project’s fair share of the transit system and contribute to the overall VMT goals of the CAP and Transit Gap Study.”</p> <p>As discussed in the comments on traffic impacts above, the Plan policies and actions that are cited as addressing this requirement are vague and unimplementable. The Actions and the Policy TR-2.2 must be re-written to specifically require that major new projects may not be approved unless the plans include facilities and a funding mechanism to pay for transit connections and address shortfalls in transit operating funds that have been identified in the Transit Gap Analysis, to ensure the new project pays the full cost for the transit connection needed.</p>   | <p>See the response to Comment A13-33.</p>  |
| A13-47    |      | <p><b>The DEIR Fails to Mitigate Significant Noise Impacts</b><br/>                     The DEIR determines that the increase in noise under the “build” alternatives would result in significant impacts along 14 roadway segments. DEIR at 2-21. In this instance, the DEIR fails to propose any mitigation measures whatever to reduce impacts.</p> <p>The County has a duty to consider other feasible mitigation. CEQA</p>   | <p>As described on pages 4.11-48 and 4.11-49 of the Draft EIR, the City considered mitigation measures, but they were found to be infeasible, resulting in the significant and unavoidable determination. Mitigation measures considered, but rejected as infeasible, include:</p> <ul style="list-style-type: none"> <li>▪ Technological advances for the prevention or muffling of noise from vehicles were found to be infeasible because they are beyond the jurisdiction of the City.</li> <li>▪ Universal use of noise-attenuating features, including rubberized asphalt, soundwalls,</li> </ul>   |

**COMMENTS AND RESPONSES**

| Comment # | Date | Comment   | Response   |
|-----------|------|---|--|
|           |      | Guidelines § 15126.4(a). For example, the County could consider the use of rubberized asphalt on county roadways (and committing to working with Caltrans to implement the measure on highways). Rubberized asphalt is a material that has been proven to be quite effective as a noise attenuation measure. Rubberized asphalt can result in an average of a four dBA reduction in traffic noise levels as compared to conventional asphalt. See “Report on the Status of Rubberized Asphalt Traffic Noise Reduction in Sacramento County”, Bollard & Brennan, Inc., November 1999 (attached to this letter). This level of noise attenuation is significant, as it represents a 60 percent reduction in traffic noise energy, and a clearly perceptible decrease in traffic noise. Id. <u>Mature</u> landscaping planted just outside the freeway right of way can also be effective noise mitigation. A revised DEIR must consider these and other feasible mitigation measures to reduce Project-related permanent increases in noise levels. | berms, and improved building sound insulation, were found to be infeasible. Noise reduction properties of rubberized asphalt degrades over time, and would not be sufficient to reduce noise impacts in many areas of Stockton. Aesthetic concerns, physical constraints, and other issues, including cost, safety, and pedestrian and vehicle connectivity concerns, prevent universal implementation of adequate noise-attenuating features. Improved building insulation would not address outdoor noise level increases.<br><br>Rubberized asphalt can cost significantly more than standard roadway materials, and requires more effort to maintain. <sup>1</sup> Given the City’s fiscal situation, recovering from Chapter 9 bankruptcy, the City considers application of rubberized asphalt along the City-maintained segments of impacted roadways to be infeasible. Similarly, due to a lack of jurisdiction, application of rubberized asphalt on State-maintained impacted roadways is also considered infeasible.<br><br><sup>1</sup> Almassy, Jodi, City of Stockton Deputy Public Works Director. Personal communication with David Stagnaro, City of Stockton Planning Manager. September 13, 2018. |
| A13-48    |      | <b>The DEIR Fails to Adequately Analyze and Mitigate for the General Plan’s Lack of Adequate Water Supply.</b><br>As with the other sections of the DEIR, the impact analysis and mitigation measures for groundwater supply, surface water supply, wastewater, and storm drainage systems are legally inadequate because only a portion of the total growth (about one-third of the housing) allowed under the proposed General Plan is considered. This affects the analysis in both the Hydrology and Water Quality, and Utilities and Services Systems chapters of the DEIR.  | See Master Response #2, Development Projections, in Section 5.1 of this Chapter.   |
| A13-49    |      | In summary, the analysis and conclusion related to impacts to groundwater supplies contained in both chapters is not supported by the facts. The City’s intent to more than triple groundwater pumping may not be realized and thus reliance on groundwater may be seriously over-estimated.  | See the responses to Comments A13-52 through A13-55.   |
| A13-50    |      | In addition, the water supply analysis for the year 2040 portion of the growth is flawed because the water supply projections for 2040 assume 50,000 acre-feet from the City’s Delta Water Supply Project, which is dependent on a permit approval by the State Water Resources Control Board, which may not occur.   | See the West Yost technical memorandum (TM) provided in Appendix B to this Final EIR, which provides more detail about the water supply analysis. The TM demonstrates that, regardless of whether the City can draw a water supply of 33,600 or 50,000 acre-feet per year (afy) from the Delta, there is adequate water supply to serve the projected 2040 development under the proposed General Plan. The TM also demonstrates that the minimum allowable Delta water supply will likely be close to 50,000 afy, based on typical treated wastewater flows of 48,394 afy discharged into the Delta and California Water Code Section 1485, Water Rights, which allows the City to take out of the Delta as much water as the City’s wastewater treatment plant discharges into the Delta.  |
| A13-51    |      | Finally, the water supply analysis does not fulfill the requirements of the State Water Code.   | See the response to Comment A13-61.  |

## COMMENTS AND RESPONSES

| Comment # | Date | Comment  | Response   |
|-----------|------|--|--|
| A13-52    |      | <p>In the Hydrology chapter, Impact HYDRO-2.1 states: "Implementation of the proposed project would not substantially deplete groundwater supplies." This is not an accurate conclusion based on the facts that are presented in the DEIR, as we note below.</p> <p>The DEIR describes the very serious groundwater situation:</p> <p>"The Eastern San Joaquin Subbasin is identified as a critically overdrafted groundwater basin. Average groundwater use in the Eastern San Joaquin Subbasin is about 809,321 acre-feet per year (afy), of which approximately 95 percent is for agricultural uses and 5 percent for municipal and industrial uses. Historically, groundwater elevations have declined about 40 to 60 feet, averaging approximately 1.7 feet per year. As a result, a regional cone of depression has formed in eastern San Joaquin County, creating a gradient that allows saline water underlying the Delta region to migrate northeast within the southern portions of the EIR Study Area.</p> <p>Extensive groundwater pumping has caused movement of the saline waters eastward from under the San Joaquin Delta. Groundwater flow in the Basin now converges on the depression with relatively steep groundwater gradients eastward from the Delta toward the depression east of Stockton. The eastward flow from the Delta area is significant because of the typically poorer quality water now moving eastward in the Stockton area. Degradation of water quality due to saline migration threatens the long-term sustainability of the underlying basin. Salt-laden groundwater is unusable for urban drinking water needs and for irrigating crops." DEIR at 4.9-13 and 14.</p> <p>Critically overdrafted groundwater basins, including the Eastern San Joaquin Subbasin, are required to be managed under a Groundwater Sustainability Plan by January 31, 2020. The very perfunctory description of this important new law (the Sustainable Groundwater Management Act) on page 4.9-15 of the DEIR should be augmented to include the detailed requirement of the law and its required plan and implementation.</p> | <p>As requested in the comment, the description of the Sustainable Groundwater Management Act on page 4.9-7 of the Draft EIR has been augmented, as shown in Chapter 3 of this Final EIR.</p>  |
| A13-53    |      | <p>Groundwater supplies for the City's two water purveyors (Cal Water and the City) are forecast to increase from about 13,368 acre-feet per year (afy) in 2015 to 29,840 afy in 2040. Cal Water is using only 6,740 afy of groundwater in 2015 and is forecast to rely on that same amount of pumping through 2040. In stark contrast, the City currently pumps about the same amount as Cal Water (6,628 afy) but intends to more than triple that amount by 2020 (23,100 afy) and continue pumping at that rate through 2040 (Table 4.15-1). The analysis in both the Hydrology and the Utilities chapters must provide</p>   | <p>As reported in the City of Stockton's 2015 UWMP, the sustainable groundwater yield is 0.75 acre-feet/acre/year, equivalent to a groundwater yield of approximately 50,000 afy. To establish the projected groundwater supply that is reasonably available, the UWMP assumes that the reasonably available groundwater for the current water service area (38,524 acres) is pumped at 0.6 acre-feet/acre/year, equivalent to an annual groundwater supply of 23,100 afy, which is the amount assumed to be available by 2040 to serve development that could occur under the proposed General Plan. This amount of groundwater has been determined by the applicable water agency to be within the</p> |



## COMMENTS AND RESPONSES

| Comment # | Date | Comment   | Response   |
|-----------|------|---|--|
|           |      | evidence to support the conclusion that tripling the amount of groundwater pumping to serve new growth would not deplete groundwater supplies.  | <p>sustainable yield, and the proposed project would not require additional supplies beyond this sustainable yield.</p> <p>Furthermore, the City's UWMP also specifies that the City will maximize the use of surface water over groundwater. As described in the response to Comment A13-50 and shown in Appendix B to this Final EIR, there is a surplus water supply of 31,003 afy for development under the proposed General Plan within the City of Stockton Municipal Utilities Department (COSMUD) service area, even if the City's supply from the Delta Water Supply Project remains at 33,600 afy. There is also evidence provided in Appendix B that demonstrates that the available supply from the Delta Water Supply Project will actually be closer to 50,000 afy, indicating an even greater drought surplus. Therefore, the 23,100 afy from groundwater sources would not be required to serve the proposed General Plan.</p> <p>In summary, the proposed General Plan would not contribute to an increase in the need for groundwater pumping by COSMUD, and, even if it did rely on the groundwater supply identified in the 2015 UWMP, it would be within a sustainable yield.</p> |
| A13-54    |      | The DEIR contains the following statement that is not discussed or includes no technical study citation: "COSMUD pumps groundwater from the East San Joaquin Subbasin of the San Joaquin Valley Groundwater Basin. The City estimates the sustainable groundwater yield to be approximately 50,000 afy." DEIR 4.15-5. Please provide the scientific basis for this unsupported statement.   | The source of this statement is the City of Stockton 2015 UWMP. Page 4.15-5 of the Draft EIR has been revised to provide this citation, as shown in Chapter 3 of this Final EIR.   |
| A13-55    |      | The City's plans to more than triple groundwater pumping may not be implemented and the DEIR must describe and analyze this possibility. Groundwater supplies to serve growth in north Stockton may not increase if a reduction or curtailment of pumping becomes a management tool to address the Eastern San Joaquin Groundwater Subbasin critically overdrafted state. The analysis in the Hydrology and Utilities chapters fails to adequately explain and disclose the ramifications of the pending Groundwater Sustainability Plan, and how overall groundwater supplies may be affected in the future. The DEIR analysis must be augmented with a realistic discussion of how implementation of the Sustainable Groundwater Management Act may affect future groundwater water for the City. | The referenced Groundwater Sustainability Plan (Plan) is due for completion by January 2020. Analysis of effects of potential Plan requirements would be speculative and thus would not further inform decision-making and public participation. See the response to Comment A13-53 regarding the surplus water supply available to serve development under the proposed General Plan. As described in that response and in Appendix B to this Final EIR, the water demands resulting from the project in the COSMUD service area can be met by using surface water supplies only. See also the response to Comment A13-52 regarding Draft EIR text additions to provide more detail about the Sustainable Groundwater Management Act and the pending Plan.  |
| A13-56    |      | In the Utilities chapter, the perfunctory discussion of the City's existing Delta Water Supply Project and planned expansions must be augmented to tell the whole story. There must be a full discussion about how the City's extraction of delta water is contingent on discharge volumes from the City of Stockton Waste Water Treatment Plant.   | As requested, this information has been added to page 4.15-5 of the Draft EIR, as shown in Chapter 3 of this Final EIR. See also the analysis of water rights based on discharge volumes from the wastewater treatment plant in Appendix B to this Final EIR. As indicated in the appendix, average wastewater flows in 2017 were over 48,000 afy, indicating that the minimum allowable Delta water supply will likely be close to 50,000 afy.  |

## COMMENTS AND RESPONSES

| Comment # | Date | Comment  | Response |
|-----------|------|--|----------|
|           |      | <p>The text currently states:</p> <p>COSMUD also obtains surface water from the San Joaquin Delta via the Delta Water Supply Project (DWSP) at the DWSP intake facility on the San Joaquin River west of the northern part of the EIR Study Area. The DWSP includes a water treatment plant with 30 mgd capacity. The DWSP is expected to be expanded to 90 mgd capacity by 2035, with annual production of about 44.6 mgd. DEIR at 4.15-5.</p> <p>The following text from the City’s 2015 Urban Water Management Plan should be summarized and inserted into the DEIR.</p> <p>The City has developed a new surface water supply, Delta water at the DWSP intake facility, from the San Joaquin River. The objective of this supply is to achieve a long-term reliable water supply from the Delta for existing and future customers. The City has rights to Delta water because portions of the COSMA fall within the legally defined Delta and the area of origin. The City’s water rights application addressed a long-term planning horizon through the year 2050, requesting an ultimate diversion of 160 million gallons per day (mgd) (125,900 ac-ft/yr). The State Water Resources Control Board (SWRCB) divided the water rights application into two separate applications, Application 30531A and 30531B. Application 30531A covers the initial phase of the DWSP up to 30 mgd (33,600 ac-ft/yr) and the place of use is confined to the current 1990 General Plan boundary. The initial phase was granted a water right under California Water Code Section 1485. The City has a permit from the SWRCB issued on March 8, 2006 for a 33,600 ac-ft/yr supply from the Sacramento/San Joaquin Delta.</p> <p>The DWSP intake and water treatment plant was operational in 2012 with an initial capacity of 30 mgd (33,600 ac-ft/yr). The projected capacity of the DWSP by 2035 is 90 mgd with an annual production of approximately 50,000 ac-ft/yr. The DWSP will expand as needed up to 120 mgd provided water rights are granted.</p> <p>The City’s supply from the San Joaquin River is curtailed annually from February through June of each year due to U.S. Department of Fish and Wildlife Service and Department of Fish and Game restrictions. California Water Code (CWC) Section 1485 Water Rights allows the City to take out of the Delta as much water as the City’s wastewater treatment plant</p> |          |

**COMMENTS AND RESPONSES**

| Comment # | Date | Comment  | Response   |
|-----------|------|--|--|
| A13-57    |      | <p>discharges into the Delta. This quantity, which fully covers the 33,600 ac-ft/yr, is not restricted as long as the same amount of wastewater is discharged into the Delta. Section 1485 water may be subject to pumping restriction in some months due to fish protection. UWMP at 5-6.</p> <p>The DEIR goes on to state that “Existing and forecast CWSC and COSMUD water supplies are shown in Table 4.15-1. DEIR at 4.15-5. As shown in Table 4.15-2, between 2015 and 2040, purchased water is estimated to decrease from about 51 percent to 35 percent of water sources serving the EIR Study Area; surface (Delta) water is estimated to increase from about 20 percent to 41 percent; and groundwater is estimated to decrease from about 28 percent to 24 percent. DEIR at 4.15-5.”</p> <p>Table 4.15-2 indicates that significant new volumes of surface water will be needed to serve growth by 2040, and much more water will be needed to serve the additional growth forecast in the City water service area after 2040 (an impact that is ignored in this analysis). The table indicates that the water supply from the Delta Water Supply Project is assumed to increase from the permitted 33,600 acre-feet per year to 50,000 afy in year 2040. However, that increase has not been permitted by the State and may never be approved. Even if it were approved, it may be approved with very serious restrictions that will limit water extraction by the City to only portions of the year.</p> <p>The status of the second application to the State should be updated. The DEIR analysis must also include a realistic assessment of what would happen if the second application to the State water Control Board to increase supplies pumped by the City from 33,600 to 50,000 afy were denied or if conditions placed on an approval precluded the use of water for year round uses such as new homes and businesses. The DEIR should discuss and analyze the likelihood that the second permit will be approved, and the likelihood that much stricter water supply and quality standards will be applied to all Delta water users due to the twin tunnels proposal (California Water Fix project), the Basin Plan pending before the State Water Control Board, and other related regulations. For example, if the approved Basin Plan requires additional downstream flows to mitigate Delta impacts the additional surface water quantities that the City is counting on purchasing or pumping may not be available. The DEIR should also discuss the potential of pending and sustained litigation over the Water Fix project to upset the current and future extraction of municipal water supplies from the Delta.</p> | <p>See the response Comment A13-50 and Appendix B to this Final EIR. Because the wastewater discharge to the Delta is estimated to be 48,394 afy, it is likely that the increase in Delta water supply will ultimately be approved. However, even if the Delta water supply remains limited to 33,600 afy, the City still has adequate water supply for the 2040 development that could occur under the proposed General Plan.</p> <p>The California WaterFix Draft Supplemental EIR has been published for public review (which closed on September 17, 2018). If the California WaterFix Project results in restrictions on the City's use of Delta water supply, such restrictions would need to be mitigated by the California WaterFix Project. The City will continue monitor the status of the California WaterFix Project and take appropriate steps to protect its Delta water supply.</p> <p>Based on the current status of water supply planning documents available at the time of the Notice of Preparation of this EIR, there is adequate supply to serve the project. CEQA does not require that a lead agency consider all possible scenarios from potential future changes in the regulatory and planning context; rather, as stated in Section 15125(a) of the CEQA Guidelines, "[a]n EIR must include a description of the physical environmental conditions in the vicinity of the project, as they exist <i>at the time the notice of preparation is published</i>" (emphasis added).</p> |

## COMMENTS AND RESPONSES

| Comment # | Date | Comment   | Response   |
|-----------|------|---|--|
| A13-58    |      | The DEIR analysis must also examine the relationship between existing and projected discharges at the City wastewater treatment plant. The condition of the permit from the State allows the City to take out of the Delta as much water as the City's wastewater treatment plant discharges into the Delta. Will there be sufficient discharges in the coming years to ensure that the assumptions about future water supply from the Delta are accurate?  | See Appendix B to this Final EIR. The Sewer Master Plan Supplement, dated December 13, 2017 and prepared as part of the proposed project, indicates that the three-month average influent flow entering the Regional Wastewater Control Facility was reported to be 27.0 mgd for May through July 2017, which is a reasonable estimate of the 2017 wastewater Average Dry Weather Wastewater Flow (ADWF). For treatment plant planning, the City has adopted a predicted future wastewater ADWF of 40.2 mgd for 2035 and 46.3 mgd for 2045. The City's sewer system collects the wastewater from both the City and the California Water Service – Stockton District water supply service areas. A 2040 ADWF of 43.2 mgd (48,394 afy) of treated wastewater discharged to the Delta would result in the City being able to draw 48,394 afy of water supply from the Delta. Thus, it is likely that the minimum allowable Delta water supply will be close to 50,000 afy. As demonstrated in the appendix and responses to Comments A13-50, A13-55, A13-56, and A13-57, there will be adequate supply to serve future development under the proposed General Plan. |
| A13-59    |      | Impact UTIL-1 states that "Implementation of the proposed project would have sufficient water supplies available to serve the proposed project from existing entitlements. The text goes on to state "Development allowed by the proposed General Plan is forecast to increase water demands in the EIR Study Area by about 17.7 mgd to total 66.3 mgd, as shown in Table 4.15-5. The increase would be about 36 percent over existing water demands, which are approximately 48.6 mgd. About 82 percent of the net increase in water demands would occur in COSMUD's service area, that is, the northern and southern parts of the EIR Study Area. COSMUD's service area also covers the majority of the approved and pending projects, which, as shown in Table 4.15-5, constitute the majority of the net increase in projected water demands that would occur in the SOI by GPU Horizon Year 2040." DEIR at 4.15-8 and 9. | See Master Response #2, Development Projections, in Section 5.1 of this Chapter.   |
|           |      | This conclusion is not accurate since only a portion of the growth (about one-third) allowed by the Plan is evaluated.  |  |
| A13-60    |      | Also, the impact statement refers to "existing entitlements" which cannot include the 50,000 afy from the Delta because it has not been approved by the State.  | See the responses to Comments A13-50, A13-55, A13-56, and A13-57, and Appendix B to this Final EIR, which demonstrate that there will be adequate supply to serve future development under the proposed General Plan, even if the City is limited to the existing 33,600 afy entitlement from the Delta water supply. Furthermore, as explained in those responses and the appendix, the City will be able to draw the same volume of Delta water supply as it discharges treated wastewater to the Delta (48,394 afy). Thus, it is likely that nearly the full 50,000 afy of Delta water will ultimately be available to the City.  |
| A13-61    |      | Finally, the City is required by State law to complete a detailed Water Supply Assessment for the proposed General Plan since it is a significant General Plan Amendment that requires an EIR. Normally, a separate detailed Water  | Section 10910 of the California Water Code requires a Water Supply Assessment (WSA) for certain projects, with "project" defined in Section 10912. Section 10912 defines the projects needing a WSA, and requires a WSA for the following:   |

**COMMENTS AND RESPONSES**

| Comment # | Date | Comment   | Response  |
|-----------|------|---|---|
|           |      | <p>Supply Assessment is completed, attached as an appendix to the EIR, and its conclusions are summarized in the EIR chapters. The DEIR contains no such document and it appears the City has not prepared a study. The requirements for the Water Supply Assessment were enacted in Senate Bill 610 (Costa, 2001) and are codified in Section 10910 of the State Water Code.</p>   | <p>(1) A proposed residential development of more than 500 dwelling units.<br/>                 (2) A proposed shopping center or business establishment employing more than 1,000 persons or having more than 500,000 square feet of floor space.<br/>                 (3) A proposed commercial office building employing more than 1,000 persons or having more than 250,000 square feet of floor space.<br/>                 (4) A proposed hotel or motel, or both, having more than 500 rooms.<br/>                 (5) A proposed industrial, manufacturing, or processing plant, or industrial park planned to house more than 1,000 persons, occupying more than 40 acres of land, or having more than 650,000 square feet of floor area.<br/>                 (6) A mixed-use project that includes one or more of the projects specified in this subdivision.<br/>                 (7) A project that would demand an amount of water equivalent to, or greater than, the amount of water required by a 500 dwelling unit project.</p>   |
| A13-62    |      | <p>The brief and conclusory analysis on water supplies contained in the DEIR does not comply with the technical requirements of State law. The DEIR relies entirely on a brief summary of the adopted 2015 Urban Water Management Plans for Cal Water Service and the City of Stockton. These UWMPs are based on land use data and projections that are not the same as the growth allowed under this proposed General Plan. The omission of a legally adequate Water Supply Assessment must be corrected and the DEIR must be recirculated to give members of the public an opportunity to review the study.</p> | <p>Thus, the Water Code does not require a WSA for an update of the City's General Plan, and a WSA will not be prepared for this EIR.</p> <p>See Appendix B to this Final EIR. The available water supplies for the City and California Water Service - Stockton District were taken from each agency's 2015 UWMP. The available water supplies are not dependent on the proposed General Plan. The water <i>demands</i>, however, are dependent on the proposed General Plan. The water demands for both the City and California Water Service were estimated in the Potable Water Master Plan Supplement, dated December 12, 2017 and prepared as part of the proposed project based on the proposed land use plan; results were incorporated into the Draft EIR. By comparing the available water supplies from the 2015 UWMPs with the water demands resulting from the proposed project, it is concluded that the City and California Water Service - Stockton District each have adequate water supplies to meet the future water demands through 2040.</p> <p>See the response to Comment A13-61 regarding WSAs.</p> |
| A13-63    |      | <p><b>Conclusion</b><br/>                 We will continue to insist that the city approve an updated General Plan and accompanying environmental impact report in conformance with State law. We have offered ample evidence that the existing DEIR, in its current form, does not meet the requirements of CEQA. The city must direct staff and the consultant to modify the draft plan and the DEIR to meet the State mandate for full disclosure of all impacts and recommend specific measures for all growth allowed under this General Plan, not just some of it.</p>                                      | <p>See Master Response #4, Draft EIR Revisions and Recirculation, in Section 5.1 of this chapter, regarding recirculation of the Draft EIR.</p> <p>This comment is a closing statement that summarizes the content of the letter. Please see Master Responses #1, Project Merits, #2, Development Projections, and #4, Draft EIR Revisions and Recirculation, in Section 5.1 of this chapter.</p>   |

## COMMENTS AND RESPONSES

| Comment #           | Date             | Comment   | Response   |
|---------------------|------------------|---|--|
| Attachment<br>A13-1 |                  | Page 3-26 of Project Description  | The attachment to the comment letter is acknowledged for the record and will be forwarded to the decision-making bodies as part of the Final EIR for their consideration in reviewing the project.   |
| Attachment<br>A13-2 |                  | Report on the Status of Rubberized Asphalt Traffic Noise Reduction in Sacramento County   | The attachment to the comment letter is acknowledged for the record and will be forwarded to the decision-making bodies as part of the Final EIR for their consideration in reviewing the project. See also the response to Comment A13-47.  |
| <b>A14</b>          | <b>8/10/2016</b> | <b>Governor's Office of Planning and Research</b>   |  |
| A14-1               |                  | <p>Dear David Stagnaro:</p> <p>The State Clearinghouse submitted the above named Draft EIR to selected state agencies for review. The review period closed on August 9, 2018, and no agencies submitted comments by that date. This letter acknowledges that you complied with the State Clearinghouse review requirements for draft environmental documents, pursuant to the California Environmental Quality Act.</p> <p>Please call the State Clearinghouse at (916)445-0613 if you have any questions regarding the environmental review process. If you have a question about the above-named project, please refer to the ten-digit State Clearinghouse number when contacting this office.</p> | This comment acknowledges that the Draft EIR complied with the State Clearinghouse requirements and does not address the adequacy of the Draft EIR. The comment is acknowledged for the record and will be forwarded to the decision-making bodies as part of the Final EIR for their consideration in reviewing the project. No further response is required. |
| Attachment<br>A14-1 |                  | Document Details Report State Clearinghouse Data Base   | The attachment to the comment letter is acknowledged for the record and will be forwarded to the decision-making bodies as part of the Final EIR for their consideration in reviewing the project.   |
| <b>A15</b>          | <b>8/15/2018</b> | <b>University of the Pacific</b>  |  |
| A15-1               |                  | <p>Dear Mr. Stagnaro,</p> <p>University of the Pacific has reviewed the Envision Stockton 2040 General Plan Update and Utility Master Plan Supplements Draft EIR for the City of Stockton   Public Review   June 2018 document. The document and process have been thorough and represent a commitment of the City of Stockton and its staff to develop a General Plan Update that is responsive to the residents and stakeholders within the service area.</p>   | This comment serves as an opening statement and does not address the adequacy of the Draft EIR. The comment is acknowledged for the record and will be forwarded to the decision-making bodies as part of the Final EIR for their consideration in reviewing the project. No further response is required.   |
| A15-2               |                  | <p>The University has two comments and recommendations:</p> <p>1. Proposed Land Use (Figure 3.3, Page 3-13): Parcels associated with University of the Pacific have been proposed as "Institutional" or "Residential". It is requested that all Pacific parcels be assigned the currently unused "University" designation rather than either "Institutional" or "Residential". Furthermore, Pacific staff would like to meet with City of Stockton staff and consultants, as appropriate, to discuss how this designation could be implemented.</p>   | The comment is noted. The comment does not address the adequacy of the Draft EIR. Please see Master Response #1, Project Merits, in Section 5.1 of this chapter.   |

**COMMENTS AND RESPONSES**

| Comment # | Date | Comment  | Response   |
|-----------|------|--|--|
| A15-3     |      | <p>2. Throughout the draft EIR there are policies, goals and/or actions that address impacts on construction activities. When these are based on existing regulations, statutes, laws, ordinances and/or other requirements, there are no concerns. It was not clear that all proposed policies, goals and/or actions are based upon these existing requirements. It was also unknown if input was solicited and received from builders and developers, both local to and doing work within the City of Stockton, who would be directly impacted by these policies, goals and/or actions. It is possible that some of these proposed policies, goals and/or actions may negatively impact (a) construction costs, (b) construction schedules, (c) competitiveness of local builders and/or developers, and/or (d) number of builders and/or developers interested in working within the City of Stockton. Construction and development are a key component of this General Plan Update and are important to the growth and sustainability of University of the Pacific. It is recommended that builder and developer groups be specifically asked to provide comments on this document.</p> <p>University of the Pacific is grateful for the opportunity to review and provide comments on this General Plan Update. We look forward to continuing discussions with City staff, one of the University's critical local partners, as the Update is finalized.</p> | <p>The comment expresses a general opinion about the proposed project and does not address the adequacy of the Draft EIR. Please see Master Response #1, Project Merits, in Section 5.1 of this chapter.</p> |

**Members of the Public**

|            |                  |   |  |
|------------|------------------|---|--|
| <b>B01</b> | <b>7/19/2018</b> | <b>Dean Plassaras</b>   |  |
| B01-1      |                  | <p>Dear David:</p> <p>The proposed "Education and Economic enterprise zone" introduced in the 2040 General Plan draft fails to deliver the intended benefits. According to the consultants aiding the city in articulating such zoning designation, the aim is:</p> <p>"Development in this designation is intended to support the City's economic development goals by attracting new businesses, industries, and/or educational institutions that provide high-quality jobs to the local workforce. By bringing major job-generators to Stockton, this designation supports the City's Economic Development Strategic Plan and State Executive Orders regarding greenhouse gas (GHG) reduction, Senate Bill (SB) 32, and the San Joaquin Sustainable Communities Strategy. Businesses envisioned for this designation include those within a Core Business Cluster industry, as specified in the City's Economic Development Strategic Plan, that provide a significant number of jobs offering wages averaging above Area Median</p> | <p>This comment outlines a section of the proposed project and does not specifically address the adequacy of the Draft EIR. The comment is acknowledged for the record and will be forwarded to the decision-making bodies as part of the Final EIR for their consideration in reviewing the project. No further response is required.</p> |

## COMMENTS AND RESPONSES

| Comment # | Date | Comment   | Response  |
|-----------|------|---|---|
| B01-2     |      | <p>Income, and that cannot be reasonably accommodated elsewhere within the city limit. In support of a major job-generator, this designation promotes linked transportation and housing options so that future employees can live close to their jobs and commute using transportation modes that support the City's vehicle miles traveled (VMT) reduction goals. Businesses that reduce VMT by providing vanpool programs, car share services, and active transportation alternatives are encouraged. The designation also allows proximate housing stock that supports the job generator, including single-family, multi-family, and/or mixed-use dwellings at various levels of affordability, with housing costs that generally correspond to the income levels of the jobs generated by the project. The City will negotiate with applicants to develop community benefit through development agreements that identify desired community amenities in the area of development and will ensure that development mitigates its environmental impacts as feasible, pursuant to the California Environmental Quality Act (CEQA). The maximum anticipated FAR is 0.6 and the maximum anticipated density is 24 dwelling units per gross acre; however, the designation allows variation from these standards with City approval to achieve the economic development goals and complete communities described above. Development proponents are encouraged to propose creative and innovative master plans to further the City's economic development goals consistent with the policies outlined above."</p> <p>Even though the above description might be a fine declaration of intent, it nevertheless falls short by entrapping the city in an unrealistic impressionist game of false expectations.</p> <ol style="list-style-type: none"> <li>1. If the purpose of the 2040 GP is to bolster the vitality and dynamism of the downtown area and Stockton CBD, then it follows that such zoning belongs in areas much closer and/or part of downtown with much higher FAR possibilities rather than on the north side of 8 Mile Rd., which is a borderlands area and a hard city edge and not an incubator of better economic choices by an area facing serious enlargement constraints.</li> <li>2. The word "enterprise" when used in zoning matters implies heavy subsidies in the form of land and amenities needed by the Googles, Amazons, Teslas of this world; not to mention academic institutions which actually face constrained budgets and depend on very generous contributions, entailing free land and other substantial monetary outlays which are usually easily outbid by competing cities for the privilege of attracting same users.</li> </ol> | <p>The comment expresses a general opinion about the proposed project and does not address the adequacy of the Draft EIR. Please see Master Response # 1, Project Merits, in Section 5.1 of this chapter.</p> |



**COMMENTS AND RESPONSES**

| Comment # | Date | Comment   | Response  |
|-----------|------|---|---|
|           |      | <p>3. This proposed zoning has the appearance of a bad political compromise, the proverbial "a camel is a horse designed by a committee" and lacks the seriousness which sophisticated players in real estate respond to in a positive way.</p>   |   |
|           |      | <p>4. "Zoning is a complex set of regulations that municipalities use to control the use of all parcels of land in private ownership in their jurisdiction. It is clear that the original motivation for zoning was the control of negative externalities that arose in the largely unregulated urban land market of the early twentieth century. However, local officials and residents learned that zoning could also be used for fiscal and/or exclusionary purposes. This realization turns zoning into a topic that fits within the general category of the economics of regulation—in which regulations are adopted through a political process that operates to the apparent benefit of the group with the most influence over zoning decisions. "</p> |   |
|           |      | <p>5. "Most economists agree that there is a need for policies that mitigate negative external effects in urban areas, but they question whether zoning in its current versions is on balance good social and economic policy. This is a difficult question for which there is no definitive answer at this time."</p>  |   |
| B01-3     |      | <p>In summary, this type of proposed zoning introduces uncertainty and confusion rather than clarity and demonstrable economic benefits (normally thought to be the creation of highest and best values for the community). Perhaps COS could set aside such public conversation until exogenous urban planning talent has been identified (award-winning national firm specialists ) and which is able to deliver on the topic of appropriate zoning; by definition the product of smart but attainable choices.</p>   | <p>This comment serves as a summary statement and does not specifically address the adequacy of the Draft EIR. The comment is acknowledged for the record and will be forwarded to the decision-making bodies as part of the Final EIR for their consideration in reviewing the project. No further response is required.</p> |

## COMMENTS AND RESPONSES

| Comment # | Date     | Comment  | Response   |
|-----------|----------|--|--|
| B02       | 8/1/2018 | Colleen Foster   |  |
| B02-1     |          | <p>① Public input CLEARLY opposes building homes north of 8 Mile Road. While I support flexibility for an employment generator north of 8 Mile Road, the General Plan needs to BE CLEAR that homes will NOT be permitted in this Economic &amp; Education Enterprise zone until AFTER an economic engine is secured. We do not want to open the door to the potential claim that if housing is built, an economic engine will be more likely to connect. This loophole is not consistent with Alternative C and specific language should be added to the General Plan to prevent this possible interpretation of the use of this zone.</p> | <p>The comment expresses a general opinion about the proposed project and does not address the adequacy of the Draft EIR. Please see Master Response # 1, Project Merits, in Section 5.1 of this chapter.</p>  |
| B02-2     |          | <p>② The 2035 General Plan included the recommendation for a feasibility study re Inclusionary Housing ordinance. It is also included in this draft update. It is time to actually DO the study which should be undertaken separately from any discussion of Rent Stabilization or Just Cause Eviction.</p>  | <p>This comment recommends that the City prepare a feasibility study on an inclusionary housing ordinance and does not address the adequacy of the Draft EIR. The comment is acknowledged for the record and will be forwarded to the decision-making bodies as part of the Final EIR for their consideration in reviewing the project. No further response is required.</p> |

**COMMENTS AND RESPONSES**

| Comment # | Date     | Comment   | Response  |
|-----------|----------|---|---|
| B02-3     |          | <p>③ Page 3-22 (Under land Use) has a section headed Fiscal Health is a Necessary Priority. However, the introduction to this section implies that since "a portion of sales tax from retail and business-to-business transactions goes directly to the General Fund, where it can be used to support services such as law enforcement, fire suppression and street maintenance" costs incurred by new development could be offset adequately by these revenues - but that has not historically been the case &amp; it is unlikely to change in the future.</p> <p>It would be more accurate &amp; less misleading to include a bold statement that regardless of the quote above, new housing does not generate adequate revenue to support City services. A statement of this kind should be added to this section,</p> | <p>The comment expresses a general opinion about the proposed project and does not address the adequacy of the Draft EIR. Please see Master Response # 1, Project Merits, in Section 5.1 of this chapter.</p> |
| B03       | 8/4/2018 | Patrick Wall  |   |
| B03-1     |          | No housing north of Eight Mile Road!  | <p>The comment expresses a general opinion about the proposed project and does not address the adequacy of the Draft EIR. Please see Master Response # 1, Project Merits, in Section 5.1 of this chapter.</p> |
| B04       | 8/6/2018 | Justin Grant  |   |
| B04-1     |          | <p>Mr. Stagnaro:</p> <p>I am deeply concerned and saddened by the knowledge of the changes that have taken place to our city's general plan update.</p> <p>The potential plan is a travesty to future generations for multiple reasons. Primarily, the green space that now stands between Stockton and Lodi could so quickly be lost. Lost to urban sprawl. Our community should be considering building practices that encourage infill, sustainability, and not</p>  | <p>The comment expresses a general opinion about the proposed project and does not address the adequacy of the Draft EIR. Please see Master Response # 1, Project Merits, in Section 5.1 of this chapter.</p> |

## COMMENTS AND RESPONSES

| Comment #  | Date            | Comment  | Response  |
|------------|-----------------|--|---|
|            |                 | <p>the reliance on automobiles.</p> <p>Stockton’s last general plan through 2035 did not include this distorted use of the land north of Eight Mile Road.</p> <p>I implore you to do what is in your power to not allow the destruction of our city’s northern green space boarder to be corrupted so frivolously.</p>   |   |
| <b>B05</b> | <b>8/8/2018</b> | <b>Marjie Fries</b>  |   |
| B05-1      |                 | <p>The Draft General Plan and the DEIR defines the newly re-named, non-specific “Economic and Education Enterprise” land use designation north of Eight Mile Road with a housing element of 26,710 units. This is inconsistent with the public workshops held over the last two years, where the majority favored the lands north Eight Mile Road for Agriculture/Open Space use. After the close of public input, The City Council directed staff to consider an “extraordinary” opportunity on lands north of Eight Mile Road. The new General Plan could include a policy that recognizes this opportunity: “The City will consider future amendments to the General Plan for extraordinary growth plans outside the Urban Services Boundary that include significant job generators or public institutions such as a college campus.” There must be meaningful policies or restrictions on developing the land prematurely. Notwithstanding that inclusion of this gross violation of the public trust with a developer led proposal which has had strong public opposition since 1990 when first proposed, the DEIR does not address any impacts.</p> | <p>Please see Master Response #2, Development Projections, in Section 5.1 of this chapter, which discusses the Economic and Education Enterprise designation with respect to the 2040 development projections that were evaluated in the EIR.</p> |
| B05-2      |                 | <p>The DEIR’s failure to analyze traffic and other impacts for projects assumed not to occur by 2040 (including the 3,800 acres north of Eight Mile Road) by promising that full environmental analysis and mitigation of impacts will be prepared if and when applications are submitted sometime in the future. This “piecemealing”, or segmenting of a project and the deferral of environmental analysis is specifically prohibited by the California Environmental Quality Act and more than forty years of case law.</p>   | <p>Please see Response to Comment A13-17.</p>   |
| B05-03     |                 | <p>This DEIR analysis has arbitrarily divided the buildout of the General Plan into two separate projects: the development that is assumed to occur by 2040, and the remaining development that is expected after that date. The downfall of the DEIR analysis is that the housing growth assumed by 2040 is 41,400 units, which is only one third of the total amount of housing allowed by the General Plan land use map (120,180 units). For non-residential growth, the discrepancy is even larger: only 17% of the 293,311,000 square feet of commercial and industrial is assumed by 2040. Thus, based on the housing projections alone, the traffic, air quality, public services and other environmental impacts of the buildout of the plan are potentially</p>   | <p>Please see Master Response 2, Development Projections, in Section 5.1 of this chapter.</p>   |

**COMMENTS AND RESPONSES**

| Comment #                              | Date             | Comment  | Response  |
|--|------------------|--|---|
|  |                  | underestimated by two-thirds. The DEIR must analyze the impacts of the full level of residential, commercial, and industrial uses approved by the General Plan. The maximum level of development approved by the General Plan is the project being approved, not a “reasonably foreseeable” year 2040 scenario. Defining and analyzing “the whole of the project” being approved is a long-standing requirement under CEQA. The courts have consistently held that an EIR must examine a project’s potential to impact the environment, even if the development may not ultimately materialize. <i>Bozung v. Local Agency Formation Com.</i> (1975) 13 Cal.3d 263, 279, 282. |   |
| B05-4                                  |                  | North of Eight Mile includes some remaining prime farmland and good farmland. This area is critical to maintain and create meaningful greenbelt space between Stockton and Lodi as described in the DGP 2040.  | This comment provides background information and does not address the adequacy of the Draft EIR. The comment is acknowledged for the record and will be forwarded to the decision-making bodies as part of the Final EIR for their consideration in reviewing the project. No further response is required. |
| <b>Public Hearings Verbal Comments</b> |                  |  |   |
| <b>C01</b>                             | <b>8/22/2018</b> | <b>Richard Abood</b>   |   |
| C01-1                                  |                  | Plan includes possible sprawl within the Economic and Education Enterprise designation, which is inconsistent with the overall policy of the Envision Stockton process, good environmental policy, and public sentiment.   | The comment expresses a general opinion about the proposed project and does not address the adequacy of the Draft EIR. Please see Master Response Number 1, Project Merits, in Section 5.1 of this chapter.   |
| C01-2                                  |                  | It is unreasonable to designate 3,800 acres and add over 26,000 units into this area.  | The comment expresses a general opinion about the proposed project and does not address the adequacy of the Draft EIR. Please see Master Response Number 1, Project Merits, in Section 5.1 of this chapter.   |
| C01-3                                  |                  | Concept needs further study to answer:<br>i. What type of employer is desirable?<br>ii. What factors warrant the employer to locate north of Eight Mile Road?<br>iii. How much land is necessary for this enterprise area?<br>iv. Is housing needed or does adequate housing exist south of Eight Mile Road?<br>v. What’s the environmental impact for the entire buildout of the area past 2040?  | The comment expresses a general opinion about the proposed project and does not address the adequacy of the Draft EIR. Please see Master Response Number 1, Project Merits, in Section 5.1 of this chapter.   |
| <b>C02</b>                             | <b>8/22/2018</b> | <b>Eric Parfrey</b>  |   |
| C02-1                                  |                  | Concerned about plans for north of Eight Mile Road, which popped up at the end of the process; public was not apprised of this concept during initial public meetings, nor did they support that concept.  | The comment expresses a general opinion about the proposed project and does not address the adequacy of the Draft EIR. Please see Master Response Number 1, Project Merits, in Section 5.1 of this chapter.   |
| C02-2                                  |                  | Suggests a General Plan amendment process if a major employer is interested in locating north of Eight Mile Road.  | The comment expresses a general opinion about the proposed project and does not address the adequacy of the Draft EIR. Please see Master Response Number 1, Project Merits, in Section 5.1 of this chapter.   |
| C02-3                                  |                  | He had proposed some General Plan language for the area north of Eight Mile Road to staff, but it was ignored.   | The comment expresses a general opinion about the proposed project and does not address the adequacy of the Draft EIR. Please see Master Response Number 1, Project Merits, in Section 5.1 of this chapter.   |

## COMMENTS AND RESPONSES

| Comment #  | Date             | Comment   | Response  |
|------------|------------------|---|---|
| C02-4      |                  | Would like to see more policies on inclusionary housing and housing-related goals from the Housing Element.   | The comment expresses a general opinion about the proposed project and does not address the adequacy of the Draft EIR. Please see Master Response Number 1, Project Merits, in Section 5.1 of this chapter.   |
| C02-5      |                  | Would like to see a protected agriculture belt north of Eight Mile Road up to Harney Lane.  | The comment expresses a general opinion about the proposed project and does not address the adequacy of the Draft EIR. Please see Master Response Number 1, Project Merits, in Section 5.1 of this chapter.   |
| <b>C03</b> | <b>8/22/2018</b> | <b>Mary Elizabeth</b>   |   |
| C03-1      |                  | Wondering why the public hearings will occur after the due date for the comments.   | This comment includes a procedural questions and does not specifically address the adequacy of the Draft EIR. The comment is acknowledged and will be forwarded to the decision-making bodies as part of the Final EIR for their consideration in reviewing the project. No further response is required. |
| C03-2      |                  | There were two large development projects approved in the northern part of the city; requests that City deny an extension to the development agreement if comes up again.   | The comment expresses a general opinion and does not specifically address the adequacy of the Draft EIR. The comment is acknowledged and will be forwarded to the decision-making bodies as part of the Final EIR for their consideration in reviewing the project. No further response is required.      |
| C03-3      |                  | The City of Stockton is a groundwater sustainability agency (GSA) within the Eastern San Joaquin Subbasin, which is critically overdrafted. Requested a discussion of the nuances on how the City will interact with the other GSAs to reflect sustainability agency requirements in the regulatory setting section of the EIR. | The City understands that under the Sustainable Groundwater Management Act, the City (GSA) will need to interact with neighboring GSAs in the future. However, the actual details and agreement have not been developed and will be addressed as part of the Groundwater Sustainability Plan.             |
| <b>C04</b> | <b>8/22/2018</b> | <b>Shapresha Galloway</b>   |   |
| C04-1      |                  | Would like to see more goals, policies, and actions for safe places for youth, particularly around the Downtown movie theater.  | The comment expresses a general opinion about the proposed project and does not address the adequacy of the Draft EIR. Please see Master Response Number 1, Project Merits, in Section 5.1 of this chapter.   |
| <b>C05</b> | <b>8/22/2018</b> | <b>Erin Reynolds</b>  |   |
| C05-1      |                  | Would like to see a table of which agency is accountable for implementation of each policy in the General Plan. Reference to the City of Richmond's General Plan.   | The comment expresses a general opinion about the proposed project and does not address the adequacy of the Draft EIR. Please see Master Response Number 1, Project Merits, in Section 5.1 of this chapter.   |
| <b>C06</b> | <b>8/22/2018</b> | <b>Paul Plathe</b>  |   |
| C06-1      |                  | Oppose proposed housing north of Eight Mile Road. Would create transportation impacts, both on I-5 and the public transportation system. Transit benefits from compact cities, so extending the city further is counter-productive regarding public transportation.   | The comment expresses a general opinion about the proposed project and does not address the adequacy of the Draft EIR. Please see Master Response Number 1, Project Merits, in Section 5.1 of this chapter.   |

## COMMENTS AND RESPONSES

| Comment #   | Date             | Comment   | Response  |
|-------------|------------------|---|---|
| <b>C07</b>  | <b>8/22/2018</b> | <b>Yolanda Park</b>   |   |
| C07-1       |                  | Would like to see a table of which agency is accountable for implementation of each policy in the General Plan.   | The comment expresses a general opinion about the proposed project and does not address the adequacy of the Draft EIR. Please see Master Response Number 1, Project Merits, in Section 5.1 of this chapter. |
| C07-2       |                  | Concerned about air quality; need a program to reduce idling around schools, possibly as a partnership with the Air District, which has a similar program underway.                       | See the response to Comment A08-14.   |
| C07-3       |                  | Concerned about groundwater sustainability agency involvement (same as Mary Elizabeth).   | See the responses to Comments A08-21 and CO3-3.   |
| <b>C08</b>  | <b>8/22/2018</b> | <b>Margo Praus</b>  |   |
| C08-1       |                  | Against housing development north of Eight Mile Road; open to education or large employer use.  | The comment expresses a general opinion about the proposed project and does not address the adequacy of the Draft EIR. Please see Master Response Number 1, Project Merits, in Section 5.1 of this chapter. |
| <b>C09</b>  | <b>8/22/2018</b> | <b>Marj Fries</b>   |   |
| C09-1       |                  | No development north of Eight Mile Road / Spanos property. It is inconsistent with the process, and should not include housing.   | The comment expresses a general opinion about the proposed project and does not address the adequacy of the Draft EIR. Please see Master Response Number 1, Project Merits, in Section 5.1 of this chapter. |
| <b>C010</b> | <b>8/22/2018</b> | <b>Greg Bahr</b>  |   |
| C10-1       |                  | Expresses concern for South Stockton; should be a focus in the General Plan based on public input early in process.   | The comment expresses a general opinion about the proposed project and does not address the adequacy of the Draft EIR. Please see Master Response Number 1, Project Merits, in Section 5.1 of this chapter. |
| C10-2       |                  | Would like to see policies and actions that support growth in infill areas and other areas that are not farmland, particularly in South Stockton, without putting City at financial risk. | The comment expresses a general opinion about the proposed project and does not address the adequacy of the Draft EIR. Please see Master Response Number 1, Project Merits, in Section 5.1 of this chapter. |

## **COMMENTS AND RESPONSES**



## **6. Mitigation Monitoring and Reporting Program**

---

This Mitigation Monitoring and Reporting Program (MMRP) has been prepared for the proposed Envision Stockton 2040 General Plan Update and Utility Master Plan Supplements, herein referred to as the “proposed project.” The purpose of the MMRP is to ensure the implementation of mitigation measures identified as part of the environmental review for the proposed project. The MMRP includes the following information:

- The full text of the mitigation measures;
- The party responsible for implementing the mitigation measures;
- The timing for implementation of the mitigation measure;
- The agency responsible for monitoring the implementation; and
- The monitoring action and frequency.

The mitigation measures in this MMRP shall be applied to all future development anywhere in the city unless otherwise specified in the specific mitigation measure. The City of Stockton must adopt this MMRP, or an equally effective program, if it approves the proposed project with the mitigation measures that were adopted or made conditions of project approval.

## MITIGATION MONITORING AND REPORTING PROGRAM

**TABLE 6-1** MITIGATION MONITORING AND REPORTING PROGRAM

| Mitigation Measures  | Party Responsible for Implementation | Implementation Timing   | Agency Responsible for Monitoring                  | Monitoring Action        | Monitoring Frequency  |
|--|--------------------------------------|---|--|--------------------------|---|
| <b>AGRICULTURAL AND FORESTRY RESOURCES</b>   |                                      |   |  |                          |   |
| AG-1: Prior to project approval, if a development project will convert prime farmland, farmland of statewide importance, or unique farmland to a non-agricultural use, the project applicant shall demonstrate participation in the City's agricultural conservation program, which requires either dedication of an agricultural conservation easement at a 1:1 ratio or payment of an in-lieu agricultural mitigation fee.   | Project applicant                    | Prior to project approval   | City of Stockton Planning and Engineering Division | Plan review and approval | Once for the confirmation of program participation for each project                               |
| <b>AIR QUALITY</b>   |                                      |   |  |                          |   |
| AQ-1: Implement Mitigation Measure AQ-3 to further reduce long-term criteria air pollutant emissions.  | Project applicant                    | During the building permit and site development review process and prior to issuance        | City of Stockton Planning and Engineering Division | Plan review and approval | Once for the preparation of the technical assessment  |
| AQ-2: Prior to issuance of any construction permits for development projects subject to California Environmental Quality Act (CEQA) review (i.e., non-exempt projects), development project applicants shall prepare and submit to the City of Stockton Planning and Engineering Division a technical assessment evaluating potential project construction-related air quality impacts. The evaluation shall be prepared in conformance with San Joaquin Valley Air Pollution Control District (SJVAPCD) methodology in assessing air quality impacts. The prepared evaluation for projects that meet the SJVAPCD Small Projects Analysis Level (SPAL) screening criteria shall at minimum, identify the primary sources of construction emissions and include a discussion of the applicable SJVAPCD rules and regulations and SPAL screening criteria to support a less than significant conclusion.<br><br>For projects that do not meet the SPAL screening criteria, project-related construction emissions shall be quantified. If construction-related criteria air pollutants are determined to | Project applicant                    | During the building permit and site development review process and prior to permit issuance | City of Stockton Planning and Engineering Division | Plan review and approval | Once for the preparation of the technical assessment for construction related air quality impacts |

## MITIGATION MONITORING AND REPORTING PROGRAM

**TABLE 6-1**      **MITIGATION MONITORING AND REPORTING PROGRAM**

| Mitigation Measures  | Party Responsible for Implementation | Implementation Timing | Agency Responsible for Monitoring | Monitoring Action | Monitoring Frequency |
|--|--------------------------------------|-----------------------|-----------------------------------|-------------------|----------------------|
| <p>have the potential to exceed the SJVAPCD adopted thresholds of significance, as identified in the Guidance for Assessing and Mitigating Air Quality Impacts (GAMAQI), the City of Stockton Planning and Engineering Division shall require that applicants for new development projects incorporate mitigation measures to reduce air pollutant emissions during construction activities to below these thresholds. These identified measures shall be incorporated into appropriate construction documents (e.g., construction management plans) submitted to the City and shall be verified by the City’s Planning and Engineering Division. Mitigation measures to reduce construction-related emissions could include, but are not limited to:</p> <ul style="list-style-type: none"> <li>▪ Using construction equipment rated by the United States Environmental Protection Agency as having Tier 3 (model year 2006 or newer) or Tier 4 (model year 2008 or newer) emission limits, applicable for engines between 50 and 750 horsepower. A list of construction equipment by type and model year shall be maintained by the construction contractor on-site, which shall be available for City review upon request.</li> <li>▪ Ensuring construction equipment is properly serviced and maintained to the manufacturer’s standards.</li> <li>▪ Use of alternative-fueled or catalyst-equipped diesel construction equipment, if available and feasible.</li> <li>▪ Clearly posted signs that require operators of trucks and construction equipment to minimize idling time (e.g., five-minute maximum).</li> <li>▪ Preparation and implementation of a fugitive dust control plan that may include the following measures:                         <ul style="list-style-type: none"> <li>• Disturbed areas (including storage piles) that are not being actively utilized for construction purposes shall be effectively stabilized using water, chemical stabilizer/suppressant, or covered with a tarp or other suitable cover (e.g., revegetated).</li> <li>• On-site unpaved roads and offsite unpaved access roads</li> </ul> </li> </ul> |                                      |                       |                                   |                   |                      |

## MITIGATION MONITORING AND REPORTING PROGRAM

TABLE 6-1 MITIGATION MONITORING AND REPORTING PROGRAM

| Mitigation Measures   | Party Responsible for Implementation | Implementation Timing | Agency Responsible for Monitoring | Monitoring Action | Monitoring Frequency |
|---|--------------------------------------|-----------------------|-----------------------------------|-------------------|----------------------|
| <p>shall be effectively stabilized using water or chemical stabilizer/suppressant.</p> <ul style="list-style-type: none"> <li>Land clearing, grubbing, scraping, excavation, land leveling, grading, cut and fill, and demolition activities shall be effectively controlled utilizing application of water or by presoaking.</li> <li>Material shall be covered, or effectively wetted to limit visible dust emissions, and at least six inches of freeboard space from the top of the container shall be maintained when materials are transported offsite.</li> <li>Operations shall limit or expeditiously remove the accumulation of mud or dirt from adjacent public streets at the end of each workday. (The use of dry rotary brushes is expressly prohibited except where preceded or accompanied by sufficient wetting to limit the visible dust emissions.) (Use of blower devices is expressly forbidden.) (Utilize electric-powered vacuums or devices to capture materials.)</li> <li>Following the addition of materials to or the removal of materials from the surface of outdoor storage piles, said piles shall be effectively stabilized of fugitive dust emissions utilizing sufficient water or chemical stabilizer/suppressant.</li> <li>Within urban areas, trackout shall be immediately removed when it extends 50 or more feet from the site and at the end of each workday.</li> <li>Any site with 150 or more vehicle trips per day shall prevent carryout and trackout.</li> <li>Limit traffic speeds on unpaved roads to 15 mph.</li> <li>Install sandbags or other erosion control measures to prevent silt runoff to public roadways from sites with a slope greater than 1 percent.</li> <li>Install wheel washers for all exiting trucks or wash off all trucks and equipment leaving the project area.</li> <li>Adhere to Regulation VIII's 20 percent opacity limitation,</li> </ul> |                                      |                       |                                   |                   |                      |

## MITIGATION MONITORING AND REPORTING PROGRAM

**TABLE 6-1** MITIGATION MONITORING AND REPORTING PROGRAM

| Mitigation Measures  | Party Responsible for Implementation | Implementation Timing   | Agency Responsible for Monitoring                  | Monitoring Action        | Monitoring Frequency   |
|--|--------------------------------------|---|--|--------------------------|--|
| <p>as applicable.</p> <ul style="list-style-type: none"> <li>▪ Enter into a Voluntary Emissions Reduction Agreement (VERA) with the SJVAPCD. The VERA shall identify the amount of emissions to be reduced, in addition to the amount of funds to be paid by the project applicant to the SJVAPCD to implement emission reduction projects required for the project.</li> </ul>  |                                      |   |  |                          |  |
| <p>AQ-3: Prior to discretionary approval by the City of Stockton for development projects subject to California Environmental Quality Act (CEQA) review (i.e., non-exempt projects), project applicants shall prepare and submit a technical assessment evaluating potential project operation phase-related air quality impacts to the City of Stockton Planning and Engineering Division for review and approval. The evaluation shall be prepared in conformance with San Joaquin Air Pollution Control District (SJVAPCD) methodology in assessing air quality impacts. If operation-related air pollutants are determined to have the potential to exceed the SJVAPCD-adopted thresholds of significance, as identified in the Guidance for Assessing and Mitigating Air Quality Impacts (GAMAQI), the City of Stockton Planning and Engineering Division shall require that applicants for new development projects incorporate mitigation measures to reduce air pollutant emissions during operational activities. The identified measures shall be included as part of the conditions of approval. Possible mitigation measures to reduce long-term emissions can include, but are not limited to the following:</p> <ul style="list-style-type: none"> <li>▪ For site-specific development that requires refrigerated vehicles, the construction documents shall demonstrate an adequate number of electrical service connections at loading docks for plug-in of the anticipated number of refrigerated trailers to reduce idling time and emissions.</li> <li>▪ Applicants for manufacturing and light industrial uses shall consider energy storage and combined heat and power in appropriate applications to optimize renewable energy</li> </ul> | Project applicant                    | During the building permit and site development review process and prior to permit issuance | City of Stockton Planning and Engineering Division | Plan review and approval | Once for the preparation of the technical assessment for potential operation air quality impacts |

## MITIGATION MONITORING AND REPORTING PROGRAM

**TABLE 6-1** MITIGATION MONITORING AND REPORTING PROGRAM

| Mitigation Measures  | Party Responsible for Implementation | Implementation Timing | Agency Responsible for Monitoring | Monitoring Action | Monitoring Frequency |
|--|--------------------------------------|-----------------------|-----------------------------------|-------------------|----------------------|
| <p>generation systems and avoid peak energy use.</p> <ul style="list-style-type: none"> <li>▪ Site-specific developments with truck delivery and loading areas and truck parking spaces shall include signage as a reminder to limit idling of vehicles while parked for loading/unloading in accordance with Section 2485 of 13 CCR Chapter 10.</li> <li>▪ Provide changing/shower facilities as specified, at minimum, or greater than in the guidelines in Section A5.106.4.3 of the CALGreen Code (Nonresidential Voluntary Measures).</li> <li>▪ Provide bicycle parking facilities equivalent to or greater than as specified in Section A4.106.9 (Residential Voluntary Measures) of the CALGreen Code.</li> <li>▪ Provide preferential parking spaces for low-emitting, fuel-efficient, and carpool/van vehicles equivalent to or greater than Section A5.106.5.1 of the CALGreen Code (Nonresidential Voluntary Measures).</li> <li>▪ Provide facilities to support electric charging stations per Section A5.106.5.3 (Nonresidential Voluntary Measures) and Section A5.106.8.2 (Residential Voluntary Measures) of the CALGreen Code.</li> <li>▪ Applicant-provided appliances shall be Energy Star-certified appliances or appliances of equivalent energy efficiency (e.g., dishwashers, refrigerators, clothes washers, and dryers). Installation of Energy Star-certified or equivalent appliances shall be verified by Building &amp; Safety during plan check.</li> <li>▪ Applicants for future development projects along existing and planned transit routes shall coordinate with the City Stockton and San Joaquin Regional Transit District to ensure that bus pad and shelter improvements are incorporated, as appropriate, and that these transit improvements consider and implement design features (e.g., pullout lanes for buses) to avoid or reduce impediment/queuing of vehicles.                             <ul style="list-style-type: none"> <li>▪ Applicants for future development projects shall enter</li> </ul> </li> </ul> |                                      |                       |                                   |                   |                      |

## MITIGATION MONITORING AND REPORTING PROGRAM

**TABLE 6-1** MITIGATION MONITORING AND REPORTING PROGRAM

| Mitigation Measures  | Party Responsible for Implementation | Implementation Timing   | Agency Responsible for Monitoring                  | Monitoring Action        | Monitoring Frequency                                 |
|--|--------------------------------------|---|--|--------------------------|--|
| into a Voluntary Emissions Reduction Agreement (VERA) with the San Joaquin Valley Air Pollution Control District (SJVAPCD). The VERA shall identify the amount of emissions to be reduced, in addition to the amount of funds to be paid by the project applicant to the SJVAPCD to implement emission reduction projects required for the project.  |                                      |   |  |                          |  |
| AQ-4a: Implement Mitigation Measures AQ-2 and AQ-3 to further reduce construction and operation-related criteria air pollutant emissions.  | Project applicant                    | During the building permit and site development review process and prior to permit issuance | City of Stockton Planning and Engineering Division | Plan review and approval | Once for the preparation of the technical assessment |
| AQ-4b: Prior to discretionary approval, applicants for development projects that are subject to the California Environmental Quality Act (CEQA) shall assess their projects to the San Joaquin Valley Air Pollution Control District's (SJVAPCD) Rule 9510 Applicability Thresholds as follows: <ul style="list-style-type: none"> <li>▪ 50 residential units;</li> <li>▪ 2,000 square feet of commercial space;</li> <li>▪ 25,000 square feet of light industrial space;</li> <li>▪ 100,000 square feet of heavy industrial space;</li> <li>▪ 20,000 square feet of medical office space;</li> <li>▪ 39,000 square feet of general office space;</li> <li>▪ 9,000 square feet of education space;</li> <li>▪ 10,000 square feet of government space;</li> <li>▪ 20,000 square feet of recreational space; or</li> <li>▪ 9,000 square feet of space not identified above.</li> </ul> Applicants for development projects subject to CEQA that do not meet the SJVAPCD Rule 9510 Applicability Thresholds shall assess whether project-related construction and operational emissions exceed the SJVAPCD 100 pounds per day ambient air quality screening threshold. Applicants for development projects that exceed this ambient air quality screening | Project applicant                    | During the building permit and site development review process and prior to permit issuance | City of Stockton Planning and Engineering Division | Plan review and approval | Once for the preparation of the technical assessment |

## MITIGATION MONITORING AND REPORTING PROGRAM

TABLE 6-1 MITIGATION MONITORING AND REPORTING PROGRAM

| Mitigation Measures   | Party Responsible for Implementation | Implementation Timing   | Agency Responsible for Monitoring                  | Monitoring Action        | Monitoring Frequency                                   |
|---|--------------------------------------|---|--|--------------------------|--|
| threshold shall prepare or have prepared an ambient air quality analysis, consistent with the SJVAPCD Guidance for Assessing and Mitigating Air Quality Impacts (GAMAQI), to assess whether the subject development project would cause or contribute to a violation of any California Ambient Air Quality Standard or National Ambient Air Quality Standard. The ambient air quality analysis shall identify measures to reduce impacts as necessary. Recommended measures may include those identified in Mitigation Measures AQ-2 and AQ-3. The related recommendations of the ambient air quality analysis shall be incorporated into all construction management and design plans and which shall be submitted to the City and verified by the City's Planning and Engineering Division.   |                                      |   |  |                          |  |
| AQ-5: Prior to discretionary project approval, applicants for industrial or warehousing land uses in addition to commercial land uses that would generate substantial diesel truck travel (i.e., 100 diesel trucks per day or 40 or more trucks with diesel-powered transport refrigeration units per day based on the California Air Resources Board recommendations for siting new sensitive land uses), shall contact the San Joaquin Valley Air Pollution Control District (SJVAPCD) or the City of Stockton in conjunction with the SJVAPCD to determine the appropriate level of health risk assessment (HRA) required. If preparation of an HRA is required, all HRAs shall be submitted to the City of Stockton and the SJVAPCD for evaluation.<br><br>The HRA shall be prepared in accordance with policies and procedures of the State Office of Environmental Health Hazard Assessment and the SJVAPCD. If the HRA shows that the incremental cancer risk exceeds ten in one million (10E-06) or the risk thresholds in effect at the time a project is considered, or that the appropriate noncancer hazard index exceeds 1.0 or the thresholds as determined by the SJVAPCD at the time a project is considered, the applicant will be required to identify and demonstrate that measures are capable of reducing potential cancer and noncancer risks to an acceptable level, | Project applicant                    | During the building permit and site development review process and prior to permit issuance | City of Stockton Planning and Engineering Division | Plan review and approval | Once for the preparation of the health risk assessment |



## MITIGATION MONITORING AND REPORTING PROGRAM

**TABLE 6-1** MITIGATION MONITORING AND REPORTING PROGRAM

| Mitigation Measures  | Party Responsible for Implementation | Implementation Timing     | Agency Responsible for Monitoring                  | Monitoring Action        | Monitoring Frequency                                 |
|--|--------------------------------------|---------------------------|--|--------------------------|--|
| <p>including appropriate enforcement mechanisms.</p> <p>Measures to reduce risk impacts may include but are not limited to:</p> <ul style="list-style-type: none"> <li>▪ Restricting idling on-site beyond Air Toxic Control Measures idling restrictions, as feasible.</li> <li>▪ Electrifying warehousing docks.</li> <li>▪ Requiring use of newer equipment and/or vehicles.</li> <li>▪ Restricting offsite truck travel through the creation of truck routes.</li> </ul> <p>Measures identified in the HRA shall be identified as mitigation measures in the environmental document and/or incorporated into the site development plan as a component of the proposed project.</p>   |                                      |                           |  |                          |  |
| <p>AQ-6: Prior to project approval, if it is determined during project-level environmental review that a project has the potential to emit nuisance odors beyond the property line, an odor management plan shall be prepared and submitted by the project applicant prior to project approval to ensure compliance with San Joaquin Valley Air Pollution Control District (SJVAPCD) Rule 4102. The following facilities that are within the buffer distances specified from sensitive receptors (in parentheses) have the potential to generate substantial odors:</p> <ul style="list-style-type: none"> <li>▪ Wastewater Treatment Plan (2 miles)</li> <li>▪ Sanitary Landfill (1 mile)</li> <li>▪ Transfer Station (1 mile)</li> <li>▪ Composting Facility (1 mile)</li> <li>▪ Petroleum Refinery (2 miles)</li> <li>▪ Asphalt Batch Plan (1 mile)</li> <li>▪ Chemical Manufacturing (1 mile)</li> <li>▪ Fiberglass Manufacturing (1 mile)</li> <li>▪ Painting/Coating Operations (1 mile)</li> <li>▪ Food Processing Facility (1 mile)</li> <li>▪ Feed Lot/ Dairy (1 mile)</li> </ul> | Project applicant                    | Prior to project approval | City of Stockton Planning and Engineering Division | Plan review and approval | Once for the preparation of the Odor Management Plan |

## MITIGATION MONITORING AND REPORTING PROGRAM

**TABLE 6-1** MITIGATION MONITORING AND REPORTING PROGRAM

| Mitigation Measures   | Party Responsible for Implementation | Implementation Timing                                     | Agency Responsible for Monitoring                  | Monitoring Action              | Monitoring Frequency                           |
|---|--------------------------------------|---|--|--------------------------------|--|
| <ul style="list-style-type: none"> <li>Rendering Plant (1 mile)</li> </ul> <p>The Odor Management Plan prepared for these facilities shall identify control technologies that will be utilized to reduce potential odors to acceptable levels, including appropriate enforcement mechanisms. Control technologies may include but are not limited to scrubbers (e.g., air pollution control devices) at an industrial facility. Control technologies identified in the odor management plan shall be identified as mitigation measures in the environmental document and/or incorporated into the site plan.</p>  |                                      |   |  |                                |  |
| <b>GREENHOUSE GAS EMISSIONS</b>   |                                      |   |  |                                |  |
| <p>GHG-1: Within 24 months of adoption of the proposed General Plan, the City of Stockton shall proceed to adoption hearings for an update to its Climate Action Plan (CAP). The CAP shall provide:</p> <ul style="list-style-type: none"> <li>GHG inventories of existing and 2030 GHG levels;</li> <li>Targets for 2030 from land uses under the City’s jurisdiction based on the goals of SB 32; and</li> <li>Tools and strategies for reducing GHG emissions in accordance with the 2030 goals of the CAP.</li> </ul> <p>The City shall consider the following GHG reduction measures in its CAP Update:</p> <ul style="list-style-type: none"> <li>Reevaluate the City’s current green building requirements (Stockton Municipal Code Chapter 15.72, Green Building Standards) every five years to consider additional requirements for substantial new residential and non-residential development to ensure that new development achieves a performance objective consistent with the best performing (top 25 percent) of city green building measures in the state.</li> <li>Require financing and/or installing energy-saving retrofits on existing structures as potential mitigation measures for</li> </ul> | City of Stockton                     | Within 24 months of adoption of the proposed General Plan | City of Stockton Planning and Engineering Division | Update the Climate Action Plan | Once for the update of the Climate Action Plan |

## MITIGATION MONITORING AND REPORTING PROGRAM

**TABLE 6-1**      **MITIGATION MONITORING AND REPORTING PROGRAM**

| Mitigation Measures  | Party Responsible for Implementation | Implementation Timing | Agency Responsible for Monitoring | Monitoring Action | Monitoring Frequency |
|--|--------------------------------------|-----------------------|-----------------------------------|-------------------|----------------------|
| <p>discretionary projects that have significant GHG impacts as part of the CEQA process.</p> <ul style="list-style-type: none"> <li>▪ Utilize transfer of development rights and other mechanisms, such as an infill mitigation bank, to enhance the viability of development in the Greater Downtown.</li> <li>▪ Establish a goal for 15 percent of existing development to install solar panels over carports.</li> <li>▪ Establish a goal to achieve 10 percent of non-residential electricity and 5 percent of residential electricity entirely by solar.</li> <li>▪ Offer incentives for contractors that use electric equipment when bidding on City contracts.</li> <li>▪ Limit non-essential idling of large construction equipment to no more than 3 minutes.</li> </ul> <p>In addition, to implement the CAP, the City shall develop key ordinances, programs, and policies required to promote voluntary, incentive- based measures in the CAP, establish the planning framework for the performance-based development review process, and support and implement the local mandatory GHG reduction measures. These implementation tasks include:</p> <ul style="list-style-type: none"> <li>▪ Update the community GHG inventory to monitor emissions trends every five years.</li> <li>▪ In 2030, develop a plan for post-2030 actions.</li> <li>▪ Appoint an Implementation Coordinator to oversee the successful implementation of all selected GHG reduction strategies. The primary function of the Implementation Coordinator will be to create a streamlined approach to manage implementation of the CAP. The Implementation Coordinator will also coordinate periodic community outreach to leverage community involvement, interest, and perspectives.</li> </ul> |                                      |                       |                                   |                   |                      |

## MITIGATION MONITORING AND REPORTING PROGRAM

TABLE 6-1 MITIGATION MONITORING AND REPORTING PROGRAM

| Mitigation Measures   | Party Responsible for Implementation | Implementation Timing   | Agency Responsible for Monitoring                  | Monitoring Action        | Monitoring Frequency  |
|---|--------------------------------------|---|--|--------------------------|---|
| <b>HYDROLOGY AND WATER QUALITY</b>  |                                      |   |  |                          |   |
| HYDRO-5: Complete a citywide storm drainage master plan, including hydrologic and hydraulic models for existing land use conditions and for the land uses anticipated in 2040 under the proposed General Plan. The master plan should identify the future stormwater infrastructure needs and develop a current stormwater capital improvement plan. As part of this process, identify areas that have constraints, prioritize watersheds to be modeled, and evaluate the City stormwater fee program for potential revisions. In addition, require new development to complete stormwater plans covering drainage, flood control, and storm water quality/permitting. Use the master plan and project-level stormwater plans to assess future development, and require that future development construct the required on- and off-site infrastructure. Implementation of this mitigation measure should be timed to anticipate and precede significant developments that would be most likely to place large demands on the current stormwater system. | City of Stockton                     | To precede significant developments that would be most likely to place large demands on the current stormwater system | City of Stockton Planning and Engineering Division | Plan review and approval | Once for the completion of the citywide storm drainage master plan and ongoing as part of project approval for preparation of project-level stormwater plans. |
| <b>TRANSPORTATION AND TRAFFIC</b>   |                                      |   |  |                          |   |
| TRAF-1a: The City shall implement the following to reduce the severity of potential LOS impacts on the following City roadway segments: <ul style="list-style-type: none"> <li>▪ <b>March Lane at UPRR.</b> The adopted 2035 General Plan identifies an eight-lane cross section for this roadway from North El Dorado Street to State Route 99. The proposed General Plan envisions a six-lane cross-section through 2040. With an eight-lane cross-section, the roadway would operate within the established LOS policy. Therefore, to mitigate the impact, the City shall reserve sufficient right-of-way to accommodate an eight-lane cross-section, plus associated turn pockets at intersections. Construction of an eight-lane cross-section would result in an acceptable level of service for vehicles, but could preclude the provision of</li> </ul>   | City of Stockton                     | Ongoing   | City of Stockton Public Works                      | Ongoing                  | Ongoing   |

## MITIGATION MONITORING AND REPORTING PROGRAM

**TABLE 6-1** MITIGATION MONITORING AND REPORTING PROGRAM

| Mitigation Measures  | Party Responsible for Implementation | Implementation Timing | Agency Responsible for Monitoring | Monitoring Action | Monitoring Frequency |
|--|--------------------------------------|-----------------------|-----------------------------------|-------------------|----------------------|
| <p>facilities that would encourage higher levels of transit ridership, walking and bicycling along the corridor.</p> <p>Prior to the construction of additional roadway improvements along the March Lane corridor, the City shall conduct a focused complete streets study to analyze and evaluate peak hour and daily operations of March Lane between I-5 and State Route 99 to identify the cross-section required to accommodate existing and planned growth. The complete streets study shall consider the potential mode shift under scenarios that provide additional bicycle, pedestrian, and transit facilities along the corridor. Should the complete streets study show that corridor operations would fall within the established level of service standard for the six-lane cross-section, an implementation program of the identified bicycle, pedestrian, and transit improvements shall be required. Alternatively, the mitigation measure is to provide an eight-lane cross-section for vehicles. Implementation of this mitigation measure would reduce the potential impact to a <i>less-than-significant</i> level.</p> <ul style="list-style-type: none"> <li>▪ <b>March Lane between West Lane and Bianchi Road.</b> The adopted 2035 General Plan identifies an eight-lane cross section for this roadway from North El Dorado Street to State Route 99. The proposed General Plan envisions a six-lane cross-section through 2040. With an eight-lane cross-section, the roadway would operate within the established LOS policy. Therefore, to mitigate the impact, the City shall reserve sufficient right-of-way to accommodate an eight-lane cross-section, plus associated turn pockets at intersections.</li> </ul> <p>Prior to the construction of additional roadway improvements along the March Lane corridor, the City shall conduct a focused complete streets study to evaluate peak hour and daily operations of March Lane between I-5 and State Route 99 to identify the cross-section required to accommodate existing and planned growth. The analysis</p> |                                      |                       |                                   |                   |                      |

## MITIGATION MONITORING AND REPORTING PROGRAM

TABLE 6-1 MITIGATION MONITORING AND REPORTING PROGRAM

| Mitigation Measures  | Party Responsible for Implementation | Implementation Timing | Agency Responsible for Monitoring | Monitoring Action | Monitoring Frequency |
|--|--------------------------------------|-----------------------|-----------------------------------|-------------------|----------------------|
| <p>shall consider the potential mode shift under scenarios that provide additional bicycle, pedestrian, and transit facilities along the corridor. Should corridor operations fall within the established level of service standard with a six-lane cross-section, the study shall identify bicycle, pedestrian, and transit enhancements that are necessary to serve the corridor. Otherwise, the mitigation measure is to provide an eight-lane cross-section for vehicles. Implementation of this mitigation measure would reduce the potential impact to a <i>less-than-significant</i> level.</p> <ul style="list-style-type: none"> <li>▪ <b>Dr. Martin Luther King Jr. Boulevard between I-5 and Airport Way.</b> This section of Dr. Martin Luther King Jr. Boulevard is built out to its ultimate capacity and no further improvements are planned. Provision of parallel capacity in the area would provide alternative travel choices within this area of South Stockton, but is not expected to result in LOS D operations in the Cumulative with Proposed Plan condition. Therefore, this impact would remain <i>significant and unavoidable</i>.</li> <li>▪ <b>8<sup>th</sup> Street between Pock Lane and D Street.</b> This roadway section currently provides one travel lane in each direction with on-street parking within a 60-foot curb-to-curb right-of-way. There is sufficient right-of-way to modify the roadway cross-section to maintain on-street parking (8 feet), provide bicycle lanes (6 feet), one travel lane in each direction (10 feet), and a center two-way left-turn lane (12-feet). With modifications within the existing right-of-way, vehicular capacity could increase, reducing the impact to a less-than-significant level. Therefore, to mitigate the impact, the City shall conduct a detailed engineering study of 8<sup>th</sup> Street between El Dorado Street and Mariposa Road to identify roadway improvements that can be implemented within the existing right-of-way to improve travel for all modes, especially considering the potential for a grade-separated crossing of the railroad tracks, which would provide an</li> </ul> |                                      |                       |                                   |                   |                      |

## MITIGATION MONITORING AND REPORTING PROGRAM

**TABLE 6-1** MITIGATION MONITORING AND REPORTING PROGRAM

| Mitigation Measures   | Party Responsible for Implementation | Implementation Timing | Agency Responsible for Monitoring | Monitoring Action | Monitoring Frequency |
|---|--------------------------------------|-----------------------|-----------------------------------|-------------------|----------------------|
| <p>additional east-west connection in South Stockton. Implementation of this mitigation measure would reduce this impact to a <i>less-than-significant</i> level.</p> <ul style="list-style-type: none"> <li>▪ <b>Arch Airport Road between SR 99 and Qantas Lane.</b> This section of Arch-Airport Road is built out to its ultimate capacity and no further improvements are planned. Provision of parallel capacity in the area would provide alternative travel choices within this area of South Stockton, but is not expected to result in LOS D operations in the Cumulative with Proposed Plan condition. Therefore, this impact would remain <i>significant and unavoidable</i>.</li> <li>▪ <b>California Street between Harding Way and Park Street.</b> Prior to the construction of roadway improvements along the California Street corridor, the City shall conduct a focused complete streets study to evaluate peak hour and daily operations of California Street from north of Harding Way to south of Park Street. The evaluation shall consider the effect of providing exclusive bicycle facilities on peak hour and daily operations along the corridor. The study shall also evaluate parallel roadway facilities that could potentially see an increase in vehicle traffic with a lane reduction on California Street.<br/><br/>Should the study indicate vehicle operations would fall below the level of service standard for the facility, even considering potential traffic shifts to other roadways (and the secondary impact of those shifts), and the potential mode shift to non-auto travel modes, the mitigation measure is to retain the existing vehicle capacity and explore other alternatives for providing bicycle facilities through the corridor. Should the analysis indicate vehicle levels of service would remain within the City’s standard for the roadway facility, the mitigation measure is to construct exclusive bicycle facilities within the existing cross-section. Implementation of this mitigation measure would reduce this impact to a <i>less-than-significant</i> level.</li> </ul> |                                      |                       |                                   |                   |                      |

## MITIGATION MONITORING AND REPORTING PROGRAM

TABLE 6-1 MITIGATION MONITORING AND REPORTING PROGRAM

| Mitigation Measures   | Party Responsible for Implementation | Implementation Timing | Agency Responsible for Monitoring | Monitoring Action | Monitoring Frequency |
|---|--------------------------------------|-----------------------|-----------------------------------|-------------------|----------------------|
| <ul style="list-style-type: none"> <li> <b>B Street between Dr. Martin Luther King Jr. Boulevard and 4<sup>th</sup> Street.</b> The City shall reserve sufficient right-of-way to accommodate a four-lane cross-section, plus associated turn pockets at intersections.<br/><br/>                     Prior to the construction of additional roadway improvements along the B Street corridor, the City shall conduct a focused complete streets study to evaluate peak hour and daily operations of B Street between Dr. Martin Luther King Jr. Boulevard and Arch-Airport Road to identify the cross-section required to accommodate existing and planned growth. The analysis shall consider the potential mode shift under scenarios that provide additional bicycle, pedestrian, and transit facilities along the corridor. Should corridor operations fall within the established level of service standard with a two-lane cross-section, the study shall identify bicycle, pedestrian, and transit enhancements that are necessary to serve the corridor. Otherwise, the mitigation measure is to provide a four-lane cross-section for vehicles. Implementation of this mitigation measure would reduce the potential impact to a <i>less-than-significant</i> level.                 </li> </ul> |                                      |                       |                                   |                   |                      |
| TRAF-1b: The City shall implement the following to reduce the severity of potential LOS impacts on the following freeway segment: <ul style="list-style-type: none"> <li> <b>State Route 99 between Farmington Road and Fremont Street.</b> The Cumulative with Proposed Plan transportation analysis considers the widening of State Route 99 through Stockton to its ultimate planned width. No additional improvements have been identified. Implementation of the proposed General Plan and its associated policies are expected to provide alternative travel choices to Stockton residents and workers, shifting travel patterns and modes. However, deficient operations are expected to occur on State Route 99, and this impact would remain <i>significant and unavoidable</i>.                 </li> </ul>   | City of Stockton                     | Ongoing               | City of Stockton<br>Public Works  | Ongoing           | Ongoing              |



## MITIGATION MONITORING AND REPORTING PROGRAM

**TABLE 6-1**      **MITIGATION MONITORING AND REPORTING PROGRAM**

| Mitigation Measures  | Party Responsible<br>for Implementation | Implementation<br>Timing | Agency Responsible<br>for Monitoring | Monitoring<br>Action | Monitoring<br>Frequency |
|--|---|--------------------------|--------------------------------------|----------------------|-------------------------|
| TRAF-2: The City of Stockton shall continue to participate in planning efforts for regional transportation facilities. | City of Stockton                        | Ongoing                  | City of Stockton<br>Public Works     | Ongoing              | Ongoing                 |

## **MITIGATION MONITORING AND REPORTING PROGRAM**

APPENDIX A:  
COMMENT LETTERS





David Stagnaro

---

**From:** Hannigan, Edith@BOF <edith.hannigan@bof.ca.gov>  
**Sent:** Monday, July 2, 2018 10:33 AM  
**To:** David Stagnaro  
**Cc:** Moxley, Chad@CALFIRE  
**Subject:** RE: Envision Stockton 2040 General Plan Update - Notice of Availability (NOA)

Good morning Mr. Stagnaro,

As the City of Stockton does not have any Very High Fire Hazard Severity Zones, the Board of Forestry and Fire Protection has no recommendations.

Thank you,

Edith Hannigan  
Land Use Planning Program Manager  
Board of Forestry and Fire Protection  
PO Box 944246  
Sacramento, CA 94244-2460

(916) 862-0120  
(916) 653-0989 fax  
[edith.hannigan@bof.ca.gov](mailto:edith.hannigan@bof.ca.gov)

A01-01

**From:** David Stagnaro [mailto:David.Stagnaro@stocktonca.gov]  
**Sent:** Monday, July 2, 2018 10:14 AM  
**To:** David Stagnaro <David.Stagnaro@stocktonca.gov>  
**Subject:** FW: Envision Stockton 2040 General Plan Update - Notice of Availability (NOA)

**From:** David Stagnaro  
**Sent:** Friday, June 29, 2018 4:52 PM  
**To:** David Stagnaro <[David.Stagnaro@stocktonca.gov](mailto:David.Stagnaro@stocktonca.gov)>  
**Subject:** Envision Stockton 2040 General Plan Update - Notice of Availability (NOA)

Good Afternoon:

Based on extensive community input throughout the Envision Stockton General Plan Update process, the Draft 2040 General Plan and its associated Utility Master Plan Supplements (UMPS) have been released for public review. The draft documents, together with the Draft Environmental Impact Report (EIR) that discloses the potential environmental impacts associated with adoption and implementation of the updated General Plan and UMPS, are available for download from

the [Envision Stockton website](#); they are also available for review at the City of Stockton Community Development Department (345 N El Dorado Street in Stockton).

Please stay tuned about upcoming community meetings anticipated in July, and Planning Commission and City Council study sessions where you can provide feedback on the draft documents. A public hearing before the Planning Commission to receive comments on the adequacy of the Draft EIR has been scheduled for Thursday, August 2, 2018, at 5:30 pm in the City Council Chambers, 425 N El Dorado Street, Stockton, CA 95202. You can also submit written comments on the Draft EIR to David Stagnaro, Planning Manager, at the City of Stockton Community Development Department, 425 North El Dorado Street, Stockton, CA 95202, or email to [David.Stagnaro@stocktonca.gov](mailto:David.Stagnaro@stocktonca.gov) with “Envision Stockton EIR” as the subject. The EIR comment period will close on Friday, August 10, 2018, at 5:00 pm.

To learn more about Envision Stockton, please visit: [www.stocktonca.gov/envisionstockton](http://www.stocktonca.gov/envisionstockton) or [www.stocktonca.gov/general\\_plan](http://www.stocktonca.gov/general_plan). Please help us to spread the word about Envision Stockton by sharing this information with your friends, family, and community members.

If you have any questions, please contact David Stagnaro, Planning Manager for the City of Stockton, at 209-937-8598 or [David.Stagnaro@stocktonca.gov](mailto:David.Stagnaro@stocktonca.gov).

Thank you for your interest in the Envision Stockton 2040 General Plan update.

David

U.S. Department of Homeland Security  
FEMA Region IX  
1111 Broadway, Suite 1200  
Oakland, CA. 94607-4052

Received  
JUL 12 2018  
City of Stockton  
Community Development



July 3, 2018

David Stagnaro, Planning Manager  
City of Stockton, Community Development Department  
425 North El Dorado Street  
Stockton, California 95202

Dear Mr. Stagnaro:

This is in response to your request for comments regarding Notice of Availability of Draft Environmental Impact Report, City of Stockton, Envision Stockton 2040 General Plan Update and Utility Master Plan Supplements.

Please review the current effective countywide Flood Insurance Rate Maps (FIRMs) for the County of San Joaquin (Community Number 060299), Maps revised October 20, 2016 and City of Stockton (Community Number 060302), Maps revised October 16, 2009. Please note that the City of Stockton, San Joaquin County, California is a participant in the National Flood Insurance Program (NFIP). The minimum, basic NFIP floodplain management building requirements are described in Vol. 44 Code of Federal Regulations (44 CFR), Sections 59 through 65.

A02-01

A summary of these NFIP floodplain management building requirements are as follows:

- All buildings constructed within a riverine floodplain, (i.e., Flood Zones A, AO, AH, AE, and A1 through A30 as delineated on the FIRM), must be elevated so that the lowest floor is at or above the Base Flood Elevation level in accordance with the effective Flood Insurance Rate Map.
- If the area of construction is located within a Regulatory Floodway as delineated on the FIRM, any *development* must not increase base flood elevation levels. **The term *development* means any man-made change to improved or unimproved real estate, including but not limited to buildings, other structures, mining, dredging, filling, grading, paving, excavation or drilling operations, and storage of equipment or materials.** A hydrologic and hydraulic analysis must be performed *prior* to the start of development, and must demonstrate that the development would not cause any rise in base flood levels. No rise is permitted within regulatory floodways.

A02-02

David Stagnaro, Planning Manager  
Page 2  
July 3, 2018

- Upon completion of any development that changes existing Special Flood Hazard Areas, the NFIP directs all participating communities to submit the appropriate hydrologic and hydraulic data to FEMA for a FIRM revision. In accordance with 44 CFR, Section 65.3, as soon as practicable, but not later than six months after such data becomes available, a community shall notify FEMA of the changes by submitting technical data for a flood map revision. To obtain copies of FEMA's Flood Map Revision Application Packages, please refer to the FEMA website at <http://www.fema.gov/business/nfip/forms.shtml>.

**A02-02  
cont.**

**Please Note:**

Many NFIP participating communities have adopted floodplain management building requirements which are more restrictive than the minimum federal standards described in 44 CFR. Please contact the local community's floodplain manager for more information on local floodplain management building requirements. The Stockton floodplain manager can be reached by calling James Wong, Senior Civil Engineer, at (209) 937-8110. The San Joaquin County floodplain manager can be reached by calling John Maguire, Engineering Services Manager, at (209) 953-7617.

**A02-03**

If you have any questions or concerns, please do not hesitate to call Brian Trushinski of the Mitigation staff at (510) 627-7183.

Sincerely,



Gregor Blackburn, CFM, Branch Chief  
Floodplain Management and Insurance Branch

cc:

James Wong, Senior Civil Engineer, City of Stockton

John Maguire, Engineering Services Manager, San Joaquin County

Ray Lee, WREA, State of California, Department of Water Resources, North Central Region  
Office

Brian Trushinski, NFIP Planner, DHS/FEMA Region IX

Alessandro Amaglio, Environmental Officer, DHS/FEMA Region IX





Stockton Planning Commission  
Via e-mail only

July 23, 2018

Re: Initial Comments on Updated Stockton General Plan and DEIR (Envision Stockton)

Chair Hull and Members of the Commission:

We are writing you this letter to document our initial impressions and comments to the Updated Stockton General Plan and DEIR, for consideration by your Commission when you hold the first meeting on the plan.

The members of both our groups have been actively involved in this update process since it was initiated several years ago. We have previously submitted letters to the Commission and City Council in April, June, and July, 2017.

To sum up our impressions of the Envision Stockton program:

There is a world of difference between the manner in which the City staff and consultants are treating public participation in this most recent update, compared to the disastrous process and results that led to the previous 2007 General Plan update. Citizen involvement has been encouraged and respected. The opinions of the majority of those that participated in workshops over the last 18 months have largely been reflected in the text and policies of the proposed plan, with one notable exception: the growth planned north of Eight Mile Road.

A03-01

## **Initial Comments on General Plan Goals and Policies**

The proposed plan is a much more concise and focused document than the over-stuffed 2007 plan. This is good, since an overly lengthy plan with hundreds of policies is much more difficult to apply to land use and other planning decisions on a day to day basis. We especially appreciate Appendix A, “A Summary of Policies and Actions by Topic,” which is very handy (although we note that there doesn’t seem to be “Agricultural and Natural Resources” and “Public Facilities and Services” sections, which should be added.)

The largest single change in the new plan is the elimination of thousands of acres on the land use map of “Village” growth planned on prime agricultural lands at the periphery of the city. This feature made the 2007 plan an environmental disaster that could never, and would never, have been built. Soon after the 2007 plan was adopted the real estate market crashed, and housing demand in Stockton is now very different than what it was during the booming years of the early and mid-2000s.

The new plan rightfully heard the strong pleas from residents, business people, and concerned organizations to ensure that the new plan concentrated on infill growth, especially in the downtown and existing neighborhoods, and stop growth sprawling into the adjacent farmlands. (However, the inappropriate plans for substantial housing growth north of Eight Mile Road is grossly inconsistent with the infill goals and policies.)

In our last letter to the Commission dated June 9, 2017, we offered some dozen recommendations for additional changes to the preliminary list of General Plan goals and policies. We are pleased to see that many of these recommendations were accepted and are reflected in the draft plan. The addition of the Public Health section and its policies is also much appreciated. This was requested by many of our allies.

However, some recommendations were not accepted, and we repeat those and a couple additional policies that we have advocated in the past. We will continue to add to this list as we dive deeper into the plan.

- Add a “Sustainability/Climate Change” (or similar title) section and put in relevant goals, as noted below;
- Add goals that address climate change, greenhouse gas reduction, and clean energy (there are a few related goals and policies in the draft plan, e.g., POLICY CH-5.1 “Accommodate a changing climate through adaptation and resiliency planning and projects,” but several more should be added from the Climate Action Plan (we appreciate that the city has committed to updating the CAP);

**A03-01  
cont.**

- Add a goal that addresses need for City resiliency programs to combat climate changes due to rising sea levels and increased flood risk;
- Add a goal that addresses jobs/housing balance (POLICY LU-6.4 “Ensure that land use decisions balance travel origins and destinations in as close proximity as possible” is a start, but more specificity and consistency with the land use map is needed).;
- Add goals and policies (from Housing Element?) that address affordable housing and inclusionary housing;
- Add goals and policies that specifically support the redevelopment of struggling shopping centers into mixed use projects with a strong component of affordable housing;
- Add goals and policies that specifically address City/developer funding for increased transit services (this is required by the Settlement Agreement);
- Strengthen goals and policies related to curtailing sprawl at the City fringes and conservation of agricultural resources, and set forth detailed policies and a realistic plan to establish an “ag belt” between Stockton and Lodi, centered along Armstrong Road, and designate the ag buffer on the land use map (the existing POLICY LU-5.3 and Action LU-5.3B “Coordinate with San Joaquin County to develop a plan for a greenbelt or community separator around the city” is very vague, and will never get the job done. There should be an explicit policy to target ag lands just outside the Lodi and Stockton Spheres as a high priority for ag conservation easements, paid for by mitigation fees); and
- Add more specific goals related to crime prevention as recommended by Commissioners and members of the public.

**A03-01  
cont.**

### **What’s Happening North of Eight Mile Road?**

As expected, the most intensive fight to establish and memorialize the city’s new progressive infill-oriented growth policies is being fought over familiar territory: the 17,500 acres of agricultural lands north of 8 Mile Road that are designated in the current General Plan for future “Village” growth. The area includes 3,800 acres of prime ag land owned by the Spanos organization located north of Eight Mile Road on both sides of the I-5 freeway.

Spanos representatives have been tempting the city in recent years with visions of locating a new super job-generating use such as a technology park, or a major hospital complex, or a new college campus, on the land north of Eight Mile Road.

To recount the history of what has happened related to planning for these lands over the last several years, we quote from our July 21, 2017 letter to the City Council:

**A03-02**

Over the last year, your Council and the Planning Commission have heard hundreds of residents express their opinions about future growth patterns in our City through the well-attended workshops and public meetings that were held by City staff and consultants. At three workshops held by the City in September 2016 there was no expressed support for more low density suburban construction on agricultural land outside the existing City limits. Rather, the participants strongly favored future growth concentrated in South and downtown Stockton and supported higher intensity, mixed use, modern buildings, along with multi-family and attached housing types (see Summary of General Plan workshops).

The clear support for infill development instead of sprawl is in line with the “Vision Statement” adopted by the City to guide the General Plan program. That statement reads:

“The edges of Stockton will be discrete and clear, agriculture will continue to thrive outside the urbanized city, and Stockton residents will enjoy scenic views of agricultural land. Development and redevelopment of vacant, underutilized, and blighted areas will be prioritized over development that extends into agricultural areas, strengthening the city’s core and preserving the open space that surrounds it.” (emphasis added)

To gauge community support for smart growth policies, CCG created and distributed an online survey in late 2016. The survey asks residents of Stockton about their preferences regarding the city’s growth patterns, and the results to date (over 400 responses) are clear: A strong majority of Stocktonians prefer policies that encourage infill development in existing neighborhoods while discouraging growth outside of city limits. Residents also showed an appetite for policies that create more affordable housing, neighborhoods with access to transit, and complete streets.

With regards to where our city should grow, the results of the CCG survey were clear:

- A total of 66% of respondents agreed with the statement that “Stockton should not grow north of Eight Mile Road,” compared with 20% that disagreed.
- A total of 59% of respondents agreed with the statement that “New growth outside of Stockton City Limits should be restricted,” compared with 19% that disagreed.

At the conclusion of the public meetings in 2016, the consultant prepared three land use alternatives. Alternative C (map attached) was described as “relatively dense infill development,” and “At the edges of the city, this scenario would eliminate the “village” concept from the current General Plan, shrink the current Sphere of Influence, and reserve much of the area beyond the city limit for open space and agricultural uses.” (emphasis added)

**A03-02  
cont.**

All of the Council members agreed that the public wants Alternative C and all Council members expressed support for that alternative, not Alternatives A or B, which proposed urban development north of Eight Mile Road. A "Preferred Land Use Alternative" land use map (dated April 17, 2017) was prepared and distributed (attached).

### **From a Tesla Giga Factory to 26,000 Housing Units**

The City Council at their April 4, 2017 workshop on the General Plan talked extensively about the need to reduce unnecessary growth outside of the city limits. The same meeting included a discussion regarding the extraordinary opportunities that could occur if a major user such as a large (500-acre) Tesla-type plant or a Cal State University campus were to be proposed north of Eight Mile Road (or elsewhere in the City).

So, the original concept was for the city to reserve some land for a unique high-paying employment center that needed more acreage than could be accommodated elsewhere in the city. Housing was never discussed as a component of such a job center. Councilman Holman at the end of the April 4 meeting made a motion that was seconded to direct staff to proceed with Alternative C and "add to it to allow us to take advantage of opportunities that occur within the sphere of influence" by adding some language but that it "would not necessarily say we're going to develop in that area."

The Planning Commission discussed these issues at your meetings of June 8 and June 22, 2017.

On July 25, 2017, the City Council considered three options prepared by staff to implement an economic development strategy by reserving land north of Eight Mile Road. During the discussion, City planning staff noted argued that the amount of land that would be needed for a Tesla factory or a Cal State campus would be in the range of 500 acres. At this point during the meeting the City Manager jumped in to argue forcefully that although only about 500 acres was needed, he urged the Council to designate the entire Spanos holding of 3,800 acres for a huge job-generator, since that would give maximum flexibility to the city and a potential developer. There was still no talk about allowing housing on the land. The City Council went along with the manager's request.

Fast forward to July 2018 and the city releases the proposed General Plan and the DEIR. The draft plan defines the newly re-named "Economic and Education Enterprise" land use designation that applies to the Spanos lands and suddenly housing has been added into the equation, as follows:

Development in this designation is intended to support the City's economic development goals by attracting new businesses, industries, and/or educational institutions that provide

**A03-02  
cont.**

high-quality jobs to the local workforce...Businesses envisioned for this designation include those within a Core Business Cluster industry, as specified in the City's Economic Development Strategic Plan, that provide a significant number of jobs offering wages averaging above Area Median Income, and that cannot be reasonably accommodated elsewhere within the city limit... The designation also allows proximate housing stock that supports the job-generator, including single-family, multi-family, and/or mixed-use dwellings at various levels of affordability, with housing costs that generally correspond to the income levels of the jobs generated by the project...  
(emphasis added) (page 2-14 of the draft General Plan)

A03-02  
cont.

The amount of housing that is forecast for the Economic and Education Enterprise zone is quite substantial: 26,710 housing units. This amount of housing planned for the land north of Eight Mile Road (or the potential for any housing at all) was never discussed previously by the City Council or by this Planning Commission. The concept of building more housing at this scale north of Eight Mile Road was certainly never discussed at the public meetings we attended.

### **The DEIR Fails to Analyze Impacts Related to Buildout of 3,800 Acres of Ag Land Designated for “Economic and Education Enterprise”**

The fatal flaw of the DEIR comes in its failure to analyze the environmental impacts of any development of the 3,800 acres north of Eight Mile Road, as well as other development. The DEIR justifies this failure by offering a false distinction between “spatial” and “quantitative” inputs of data. The DEIR notes “analyses that require a quantitative estimate of growth include traffic generation, air pollution emissions, greenhouse gas emissions, noise generation, population growth, and impacts on public services and utilities and recreation.... For these analyses, the horizon-year projection (i.e., the projected amount of development that could occur under the proposed General Plan through its horizon year of 2040) was considered “reasonably foreseeable” and was used in the analysis” (page 3-28).

However, as we will see in the Table 3-3 from the DEIR (attached) and described below, the DEIR assumes that there will be NO development of any kind within the 3,800 acres between now and 2040, so impacts related to these “quantitative” topics are ignored in the DEIR, in violation of CEQA.

A03-03

In contrast, “analyses that are based on spatial location only include aesthetics, agriculture, exposure to localized air pollution and noise, biological resources, cultural resources, geology, hazards and safety, hydrology and water quality, and land use... For these analyses, the question is not *how much* development the General Plan would allow, but *where* that development could potentially be located. Therefore, all potential development allowed by the land use map of the proposed General Plan was evaluated to assess impacts in these topics (i.e., full buildout of the proposed General Plan)” (page 3-28).

So, the DEIR includes some perfunctory analysis of the “spatial” topics related to development of the 3,800 acres, but the discussion is only limited to these topics.

Table 3-3 in the DEIR (attached) is the key to understanding which development areas in the City plan have been analyzed for the full range of CEQA impacts and which areas have been ignored because projected growth is presumed to not occur until after the year 2040. The table lists the development assumptions for Study Area #1 (Eight Mile Road) in the first row. (The Study Area is defined as the area north of Eight Mile Road, as well as the “Bear Creek” projects area south of Eight Mile Road.)

The table indicates that the total amount of growth that is projected to occur by 2040 in the Eight Mile Road Study Area is 1,380 single family homes, 1,200 multi-family units, and 39,000 square feet of commercial space. According to staff and the DEIR consultant, this amount of growth is assumed to be located in the Bear Creek area south of Eight Mile Road, and that no growth by 2040 is located on the 3,800 acres of Spanos lands north of Eight Mile Road.

**A03-03  
cont.**

However, for the “full buildout” of the plan beyond year 2040, development on the Spanos lands is assumed to include 2,560 single family homes (3,940 minus the Bear Creek homes), a whopping 24,150 multi-family units, 158,000 square feet of commercial space, and over 74 million square feet of “industrial” space (which presumably includes institutional or educational uses).

Notably, assuming 3.23 people per household, the assumption that 26,710 housing units would be constructed north of Eight Mile Road under the full buildout of the plan is equivalent to adding over 86,000 new residents to the city! This DEIR fails to analyze any of the environmental impacts of this amount of new housing growth related to traffic generation, air and greenhouse gas emissions, noise, population growth, and impacts on public services and utilities and recreation.

### **“Piecemealing” a Project Is Not Allowed Under CEQA**

City staff and the consultant have justified the DEIR’s failure to analyze traffic and other impacts for projects assumed not to occur by 2040 (including the 3,800 acres north of Eight Mile Road) by promising that full environmental analysis and mitigation of impacts will be prepared if and when applications are submitted sometime in the future. This “piecemealing” or segmenting of a project and the deferral of environmental analysis is specifically prohibited by the California Environmental Quality Act and more than forty years of case law.

**A03-04**

As described by the Association of Environmental Professionals, piecemealing or segmenting means dividing a project into two or more pieces and evaluating each piece in a separate environmental document, rather than evaluating the whole of the project in one environmental document. This is explicitly forbidden by CEQA, because dividing a project into a number of

pieces would allow a Lead Agency to minimize the apparent environmental impacts of a project by evaluating individual pieces separately, each of which may have a less-than- significant impact on the environment, but which together may result in a significant impact. Segmenting a project may also hinder developing comprehensive mitigation strategies.<sup>1</sup>

In essence, this DEIR analysis has arbitrarily divided the buildout of the General Plan into two separate projects: the development that is assumed to occur by 2040, and the remaining development that is expected after that date. The downfall of the DEIR analysis is that the housing growth assumed by 2040 is 41,400 units, which is only one third of the total amount of housing allowed by the General Plan land use map (120,180 units). For non-residential growth, the discrepancy is even larger: only 17% of the 293,311,000 square feet of commercial and industrial is assumed by 2040. Thus, based on the housing projections alone, the traffic, air quality, public services and other environmental impacts of the buildout of the plan are potentially underestimated by two-thirds.

The DEIR must analyze the impacts of the *full* level of residential, commercial, and industrial uses approved by the General Plan. The maximum level of development approved by the General Plan is the project being approved, not a “reasonably foreseeable” year 2040 scenario. Defining and analyzing “the whole of the project” being approved is a long-standing requirement under CEQA. The courts have consistently held that an EIR must examine a project’s potential to impact the environment, even if the development may not ultimately materialize. *Bozung v. Local Agency Formation Com.* (1975) 13 Cal.3d 263, 279, 282.

Because general plans, such as the updated Stockton General Plan, serve as the crucial “first step” toward approval of any particular development project, the EIR must evaluate the amount of development actually allowed by the plan. *City of Carmel-By-the-Sea v. Bd. of Supervisors of Monterey County* (1986) 183 Cal.App.3d 229, 244; *City of Redlands v. County of San Bernardino* (2002) 96 Cal.App.4th 398, 409. Thus, an agency may not avoid analysis of such development merely because historic and projected land use trends indicate that the development might not occur.

In a 2005 case with facts analogous to the present situation, the Placer County Superior Court held that the agency must analyze the full amount of development being approved under a community plan (*Sierra Watch et al. v. Placer County et al.* (Placer County Superior Court No. SCV 16652)). Like the DEIR here, Placer County’s EIR assumed that full build-out of the plan would be unrealistic. The EIR reduced the level of development in the project description to a more “realistic” level that was likely to occur in the plan area. The judge found the project description to be inadequate and held, “The time to study the likely affects of specific and cumulative impacts is at the time that the potential for development is known, whether or not

---

<sup>1</sup> Association of Environmental Professionals, CEQA Portal Topic Paper posted at: <https://ceqaportal.org/tp/Project%20Description%2003-23-161.pdf>.

**A03-04  
cont.**



that development actually occurs” (citing *Christward Ministry v. Superior Court* (1986) 184 Cal.App.3d 180, 194; and *Bozung*).

A03-04  
cont.

**A Proposal**

If the city would like to limit its analysis to a predicted amount of growth, it must also limit the allowable development to that lower level by placing restrictions on growth in the general plan itself. To restrict growth to the “reasonably foreseeable” year 2040 scenario, the city could adopt a general plan policy or policies prohibiting additional housing and commercial development beyond the 2040 projections unless a new environmental impact report has been prepared and an amendment to the plan and/or rezoning is adopted.

A03-05

Over the last eighteen months, we have consistently advocated such an approach to fulfill the city’s desire to set aside land north of Eight Mile Road for a super-job-generator or state university campus. In our letters and in our testimony at the City Council workshop, and again at the Planning Commission in 2017, we explicitly note that we are not opposed to consideration of an “extraordinary” opportunity on lands north of Eight Mile Road. Last year, we recommended that the new General Plan could include a policy that recognizes this opportunity:

A03-06

“The City will consider future amendments to the General Plan for extraordinary growth plans outside the Urban Services Boundary that include significant job generators or public institutions such as a college campus.”

**Conclusion**

We will continue to insist that the city approve an updated General Plan and accompanying environmental impact report in conformance with State law. We have offered ample evidence that the existing DEIR, in its current form, does not meet the requirements of the California Environmental Quality Act. The city must direct staff and the consultant to modify the draft plan and the DEIR to meet the State mandate for full disclosure of all impacts and recommend specific measures for all growth allowed under this General Plan, not just some of it.

A03-07

We noted last year, and reiterate once again, we are totally opposed to any attempt by staff or others to back off the previous commitment by the city to designate the lands north Eight Mile Road for Agriculture/Open Space uses, and instead propose massive amounts of housing. We are opposed to a designation of any of these lands as “Economic and Education Enterprise,” with no meaningful policies or restrictions on developing the land prematurely.

A03-08

The lack of any specific policies that guide the development of lands north of Eight Mile Road leave a huge loophole in this General Plan that could be exploited by future City Councils. For example, a future Council could approve thousands of units of housing with the promise that a major job generator is about to commit to build in the area. There is nothing in this plan that would restrict the Spanos organization from applying for single or multiple family housing in the

next five years. There is nothing that would preclude the Spanos group from applying to expand the existing Spanos West subdivisions north of Eight Mile Road.

**A03-08  
cont.**

We are disappointed that we have come so far from the last disastrous General Plan yet we still are encountering these last minute manipulations to add housing north of Eight Mile Road, which has received no meaningful public review and discussion.

**A03-09**

Thank you for your consideration of these important matters. We look forward to much more discussion and debate about these issues.

Very truly yours,

ss/Eric Parfrey  
Chair, CCG and  
Chair, Sierra Club California Executive Committee

cc: Stockton City Council  
Andrew Chesley, SJCOG  
SJ County Board of Supervisors  
State Attorney General  
Rachel Hooper, Shute, Mihaly, Weinberger

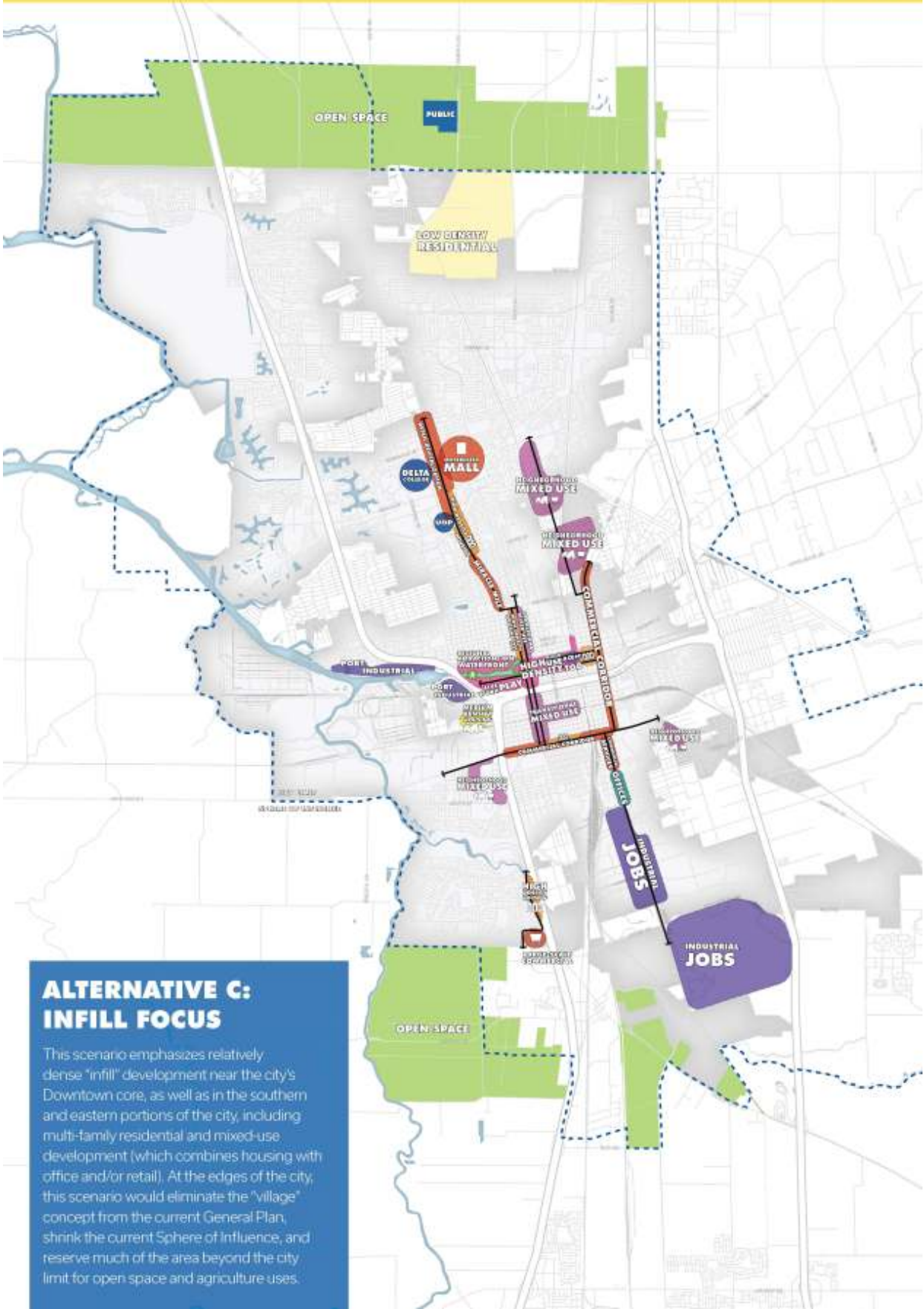

# COMMENT LETTER # A03 ATTACHMENT A03-2



Attachment C  
STOCKTON 2040 GENERAL PLAN UPDATE  
CITY OF STOCKTON

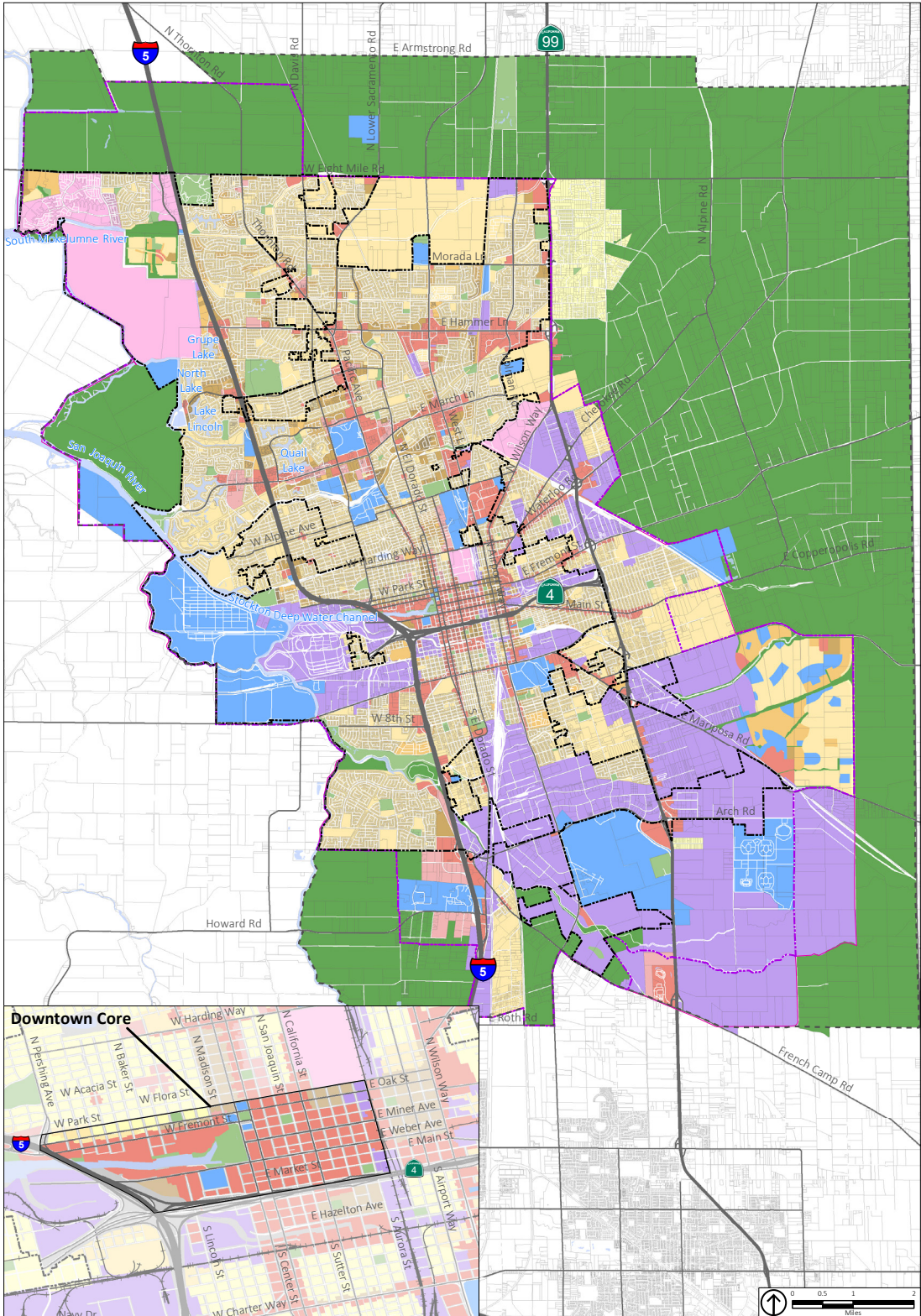

Source: City of Stockton, 2017; PlaceWorks, 2017.

- |   |   |   |  |
|---|---|---|--|
| <span style="display:inline-block; width:15px; height:15px; background-color:yellow; border:1px solid black;"></span> Residential Estate              | <span style="display:inline-block; width:15px; height:15px; background-color:grey; border:1px solid black;"></span> Village                           | <span style="display:inline-block; width:15px; height:15px; background-color:purple; border:1px solid black;"></span> Industrial                | <span style="display:inline-block; width:15px; height:15px; border:1px dashed black;"></span> General Plan Planning Area |
| <span style="display:inline-block; width:15px; height:15px; background-color:orange; border:1px solid black;"></span> Low Density Residential         | <span style="display:inline-block; width:15px; height:15px; background-color:lightpink; border:1px solid black;"></span> Mixed Use                    | <span style="display:inline-block; width:15px; height:15px; background-color:blue; border:1px solid black;"></span> Institutional               | <span style="display:inline-block; width:15px; height:15px; border:1px dotted black;"></span> Sphere of Influence        |
| <span style="display:inline-block; width:15px; height:15px; background-color:lightorange; border:1px solid black;"></span> Medium Density Residential | <span style="display:inline-block; width:15px; height:15px; background-color:lightcoral; border:1px solid black;"></span> Commercial                  | <span style="display:inline-block; width:15px; height:15px; background-color:lightgreen; border:1px solid black;"></span> Parks and Recreation  | <span style="display:inline-block; width:15px; height:15px; border:1px dashed purple;"></span> Urban Service Area        |
| <span style="display:inline-block; width:15px; height:15px; background-color:darkorange; border:1px solid black;"></span> High Density Residential    | <span style="display:inline-block; width:15px; height:15px; background-color:lightcoral; border:1px solid black;"></span> Administrative Professional | <span style="display:inline-block; width:15px; height:15px; background-color:darkgreen; border:1px solid black;"></span> Open Space/Agriculture | <span style="display:inline-block; width:15px; height:15px; border:1px solid black;"></span> City Limit                  |

DRAFT - APRIL 17, 2017

Preferred Land Use Alternative

# COMMENT LETTER # A03

## ATTACHMENT A03-3



2040 GENERAL PLAN UPDATE AND UTILITY MASTER PLAN SUPPLEMENTS  
DRAFT ENVIRONMENTAL IMPACT REPORT  
CITY OF STOCKTON

### PROJECT DESCRIPTION

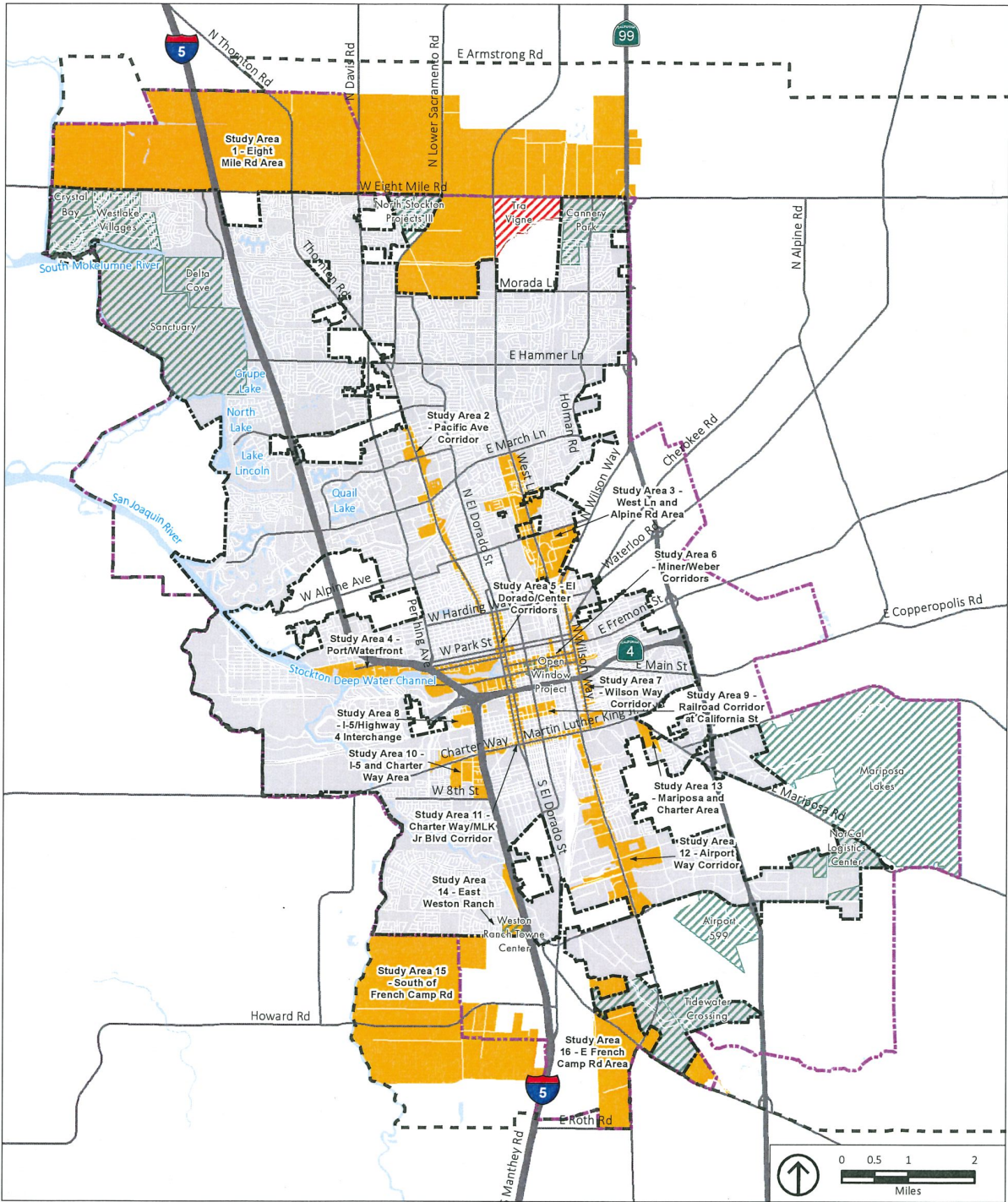

Source: City of Stockton, 2016; Placeworks, 2017.

- Study Areas
- City Limit
- Major Development Projects**
- Active/Pending Applications
- Approved Projects
- Sphere of Influence/ EIR Study Area
- General Plan Planning Area

Figure 3-5

Study Areas and Approved/Pending Projects

2040 GENERAL PLAN UPDATE AND UTILITY MASTER PLAN SUPPLEMENTS  
DRAFT ENVIRONMENTAL IMPACT REPORT  
CITY OF STOCKTON

PROJECT DESCRIPTION

TABLE 3-3 2040 DEVELOPMENT BY STUDY AREA

| Study Area #/Name                     | Net New Single-Family Units (Full Buildout) | Percent Applied to 2040 | Net New Single-Family Units (2040) | Net New Multi-Family Units (Full Buildout) | Percent Applied to 2040 | Net New Multi-Family Units (2040) | Net New Commercial Square Feet (Full Buildout) | Percent Applied to 2040 | Net New Commercial Square Feet (2040) | Net New Industrial Square Feet (Full Buildout) | Percent Applied to 2040 | Net New Industrial Square Feet (2040) |
|---------------------------------------|---|-------------------------|------------------------------------|--|-------------------------|-----------------------------------|--|-------------------------|---------------------------------------|--|-------------------------|---------------------------------------|
| 1. Eight Mile Rd                      | 3,940                                       | 35%                     | 1,380                              | 25,350                                     | 5%                      | 1,200                             | 197,000  | 20%                     | 39,000                                | 74,095,000                                     | 0%                      | 0                                     |
| 2. Pacific Ave Corridor               | 0   | 0%                      | 0                                  | 440  | 25%                     | 110                               | 188,000  | 50%                     | 94,000                                | 0  | 0%                      | 0                                     |
| 3. West Ln and Alpine Rd              | 80  | 100%                    | 80                                 | 2,720                                      | 25%                     | 680                               | 1,294,000                                      | 25%                     | 323,000                               | 0  | 0%                      | 0                                     |
| 4. Port/Waterfront                    | 20  | 100%                    | 20                                 | 2,210                                      | 80%                     | 1,770                             | 6,800,000                                      | 30%                     | 2,040,000                             | 2,323,000                                      | 25%                     | 581,000                               |
| 5. El Dorado/Center Corridors         | 0   | 0%                      | 0                                  | 1,500                                      | 80%                     | 1,200                             | 4,367,000                                      | 30%                     | 1,310,000                             | 0  | 0%                      | 0                                     |
| 6. Miner/Weber Corridors <sup>a</sup> | 0   | 0%                      | 0                                  | 1,560                                      | 80%                     | 1,250                             | 2,926,000                                      | 50%                     | 1,463,000                             | 0  | 0%                      | 0                                     |
| 7. Wilson Way Corridor                | 0   | 0%                      | 0                                  | 940  | 25%                     | 230                               | 1,213,000                                      | 50%                     | 607,000                               | 0  | 0%                      | 0                                     |
| 8. I-5/Highway 4 Interchange          | 0   | 0%                      | 0                                  | 820  | 80%                     | 660                               | 777,000  | 50%                     | 389,000                               | 0  | 0%                      | 0                                     |
| 9. Railroad Corridor at California St | 0   | 0%                      | 0                                  | 1,680                                      | 80%                     | 1,340                             | 5,197,000                                      | 25%                     | 1,299,000                             | 0  | 0%                      | 0                                     |
| 10. I-5 and Charter Way               | 90  | 100%                    | 90                                 | 980  | 10%                     | 100                               | 535,000  | 25%                     | 134,000                               | 98,000   | 85%                     | 84,000                                |
| 11. Charter Wy/MLK Jr Blvd Corridor   | 0   | 0%                      | 0                                  | 790  | 50%                     | 400                               | 1,619,000                                      | 20%                     | 324,000                               | 0  | 0%                      | 0                                     |
| 12. Airport Way Corridor              | 0   | 0%                      | 0                                  | 430  | 25%                     | 110                               | 274,000  | 75%                     | 205,000                               | 5,475,000                                      | 25%                     | 1,369,000                             |
| 13. Mariposa and Charter              | 0   | 0%                      | 0                                  | 570  | 0%                      | 0                                 | 324,000  | 25%                     | 81,000                                | 0  | 0%                      | 0                                     |
| 14. East Weston Ranch <sup>b</sup>    | 0   | 0%                      | 0                                  | 610  | 0%                      | 0                                 | 574,000  | 75%                     | 431,000                               | 0  | 0%                      | 0                                     |
| 15. South of French Camp Rd           | 0   | 0%                      | 0                                  | 0  | 0%                      | 0                                 | 0  | 0%                      | 0                                     | 0  | 0%                      | 0                                     |
| 16. E French Camp Rd                  | 0   | 0%                      | 0                                  | 0  | 0%                      | 0                                 | 0  | 0%                      | 0                                     | 0  | 0%                      | 0                                     |
| Outside of Study Areas <sup>c</sup>   | 16,360                                      | 9%                      | 1,500                              | 29,810                                     | 0%                      | 0                                 | 19,487,000                                     | 0%                      | 0                                     | 126,805,000                                    | 0%                      | 0                                     |
| <b>Grand Total<sup>d</sup></b>        | <b>20,480</b>                               |                         | <b>3,060</b>                       | <b>70,400</b>                              |                         | <b>9,040</b>                      | <b>45,773,000</b>                              |                         | <b>8,739,000</b>                      | <b>208,796,000</b>                             |                         | <b>2,033,000</b>                      |

a. Excludes Open Window approved project.  
b. Excludes Weston Ranch Town Center approved project.  
c. Excludes approved/pending projects.  
d. Numbers do not always add up due to rounding.  
Source: PlaceWorks, 2017.

# COMMENT LETTER # A03 ATTACHMENT A03-4 (CONT.)

2040 GENERAL PLAN UPDATE AND UTILITY MASTER PLAN SUPPLEMENTS  
DRAFT ENVIRONMENTAL IMPACT REPORT  
CITY OF STOCKTON

## PROJECT DESCRIPTION

- **Approved and Pending Development Projects.** As noted above in Section 3.5.2, there is significant development potential available in approved development projects that have not yet been constructed. Such projects can continue to be developed regardless of whether the City adopts the proposed General Plan. The development allowed in those approved projects, as well as development proposed in pending development projects, is included in the horizon-year projection, and was considered as part of the process to distribute the planning period development. Given the significant amount of development potential in those projects, the horizon-year projection includes more non-residential development than forecasted by the market study described above. The approved and pending development that was considered in this EIR is shown in Table 3-4.

**TABLE 3-4 NET NEW APPROVED AND PENDING DEVELOPMENT**

|  | Single-Family<br>Units | Multi-Family<br>Units | Commercial<br>Square Feet | Industrial<br>Square Feet |
|--|------------------------|-----------------------|---------------------------|---------------------------|
| <b>Approved Within City Limit</b>                      |                        |                       |                           |                           |
| Westlake Villages                                      | 2,600                  | 0                     | 0                         | 0                         |
| Delta Cove   | 1,200                  | 400                   | 31,000                    | 0                         |
| North Stockton Projects III                            | 2,200                  | 0                     | 0                         | 0                         |
| Cannery Park   | 1,000                  | 200                   | 1,079,000                 | 1,442,000                 |
| Nor Cal Logistics Center                               | 0                      | 0                     | 0                         | 6,280,000                 |
| Crystal Bay  | 1,000                  | 400                   | 0                         | 0                         |
| Sanctuary  | 5,500                  | 1,600                 | 692,000                   | 0                         |
| Tidewater Crossing                                     | 0                      | 0                     | 186,000                   | 11,625,000                |
| Open Window <sup>a</sup>                               | 0                      | 1,400                 | 0                         | 57,000                    |
| Weston Ranch Town Center                               | 0                      | 0                     | 481,000                   | 0                         |
| <b>Approved/Pending Outside City Limit, Inside SOI</b> |                        |                       |                           |                           |
| Mariposa Lakes   | 9,000                  | 1,600                 | 1,010,000                 | 11,980,000                |
| Airpark 599  | 0                      | 0                     | 1,679,000                 | 2,200,000                 |
| Tra Vigne <sup>b</sup>                                 | 1,200                  | 0                     | 0                         | 0                         |

a. The Master Development Plan for Open Window is approved for 1,034 units, with an option to expand the capacity to 1,400 units if the General Plan Update increases the maximum densities in the Downtown, which is proposed as part of the General Plan Update.

b. Pending; not approved.

Source: City of Stockton and PlaceWorks, 2017.

As part of this step, the 2008 Settlement Agreement between the City, State, and Sierra Club, which was signed in response to litigation over the 2007 adoption of the City's General Plan, was consulted. The Settlement Agreement requires the City to plan for 4,400 housing units in the Greater Downtown and an additional 14,000 units within the city limit as it existed in 2008. Therefore, the 2040 development was

PUBLIC UTILITIES COMMISSION

180 PROMENADE CIRCLE, SUITE 115  
SACRAMENTO, CA 95834



RECEIVED

JUL 26 2018

CORS No. 2018070002

CITY OF STOCKTON  
PERMIT CENTER / PLANNING DIV.

July 23, 2018  
  
David Stagnaro  
City of Stockton  
Community Development Department  
425 North El Dorado Street  
Stockton, CA 95202

**Re: SCH 2017052062 Notice of Availability - Draft Environment Impact Report Stockton 2040 General Plan Update**

Mr. Stagnaro:

The California Public Utilities Commission (Commission) has jurisdiction over the safety of highway-rail crossings (crossings) in California. The California Public Utilities Code requires Commission approval for the construction or alteration of crossings and grants the Commission exclusive power on the design, alteration, and closure of crossings in California. The Commission Rail Crossings Engineering Branch (RCEB) has received the Notice of Availability for the *Draft Environment Impact Report (DEIR)* from the State Clearinghouse for the proposed City of Stockton (City) Stockton 2040 General Plan Update.

A04-01

According to the DEIR, the project area includes active railroad tracks. RCEB recommends that the City add language to the Stockton 2040 General Plan Update so that any future development adjacent to or near the rail right-of-way (ROW) is planned with the safety of the rail corridor in mind. New developments may increase traffic volumes not only on streets and at intersections, but also at at-grade highway-rail crossings. This includes considering pedestrian circulation patterns or destinations with respect to railroad ROW and compliance with the Americans with Disabilities Act. Mitigation measures to consider include the planning for grade separations for major thoroughfares, improvements to existing at-grade crossings due to increase in traffic volumes, and continuous vandal resistant fencing or other appropriate barriers to prevent trespassers onto the railroad ROW.

A04-02

A04-03

If you have any questions regarding this matter, or any other issues, please feel free to contact me at (916) 928-2515.

Sincerely,

David Stewart  
Utilities Engineer  
Rail Crossings and Engineering Branch  
Safety and Enforcement Division



**From:** David Butz  
**To:** [David Stagnaro](#)  
**Subject:** Bright Development Property Adjacent McNair High School (Gen Plan Update)  
**Date:** Thursday, August 02, 2018 11:37:40 AM  
**Attachments:** [image001.png](#)  
[2040 General Plan Snip Bear Creek Properties.PNG](#)

---

Hi Dave, we were looking at the new Land Use Map for the General Plan Update and noticed that the Land Use Designation for the property on the West Side of McNair High School was changed to include MDR and HDR Designations from the previous map that showed all LDR. We were wondering what was the catalyst for this change, if we have a choice in the matter, and if you have any backup information that might help us clarify the need to change. At this point we don't know if it is a good thing or bad thing and we haven't taken a position on it but we would like to discuss with you. Can we set up a meeting or phone call? Let me know.

A05-01

Thanks

**Dave Butz**  
*Director of Forward Planning and Development*  
*Bright Development*  
*1620 N. Carpenter Rd. Bldg. B*  
*Modesto, CA 95351*  
*(209) 526-8242 Office*  
*(209) 571-9457 Direct*  
*(209) 652-3721 Cell*  
[dbutz@bright-homes.com](mailto:dbutz@bright-homes.com)



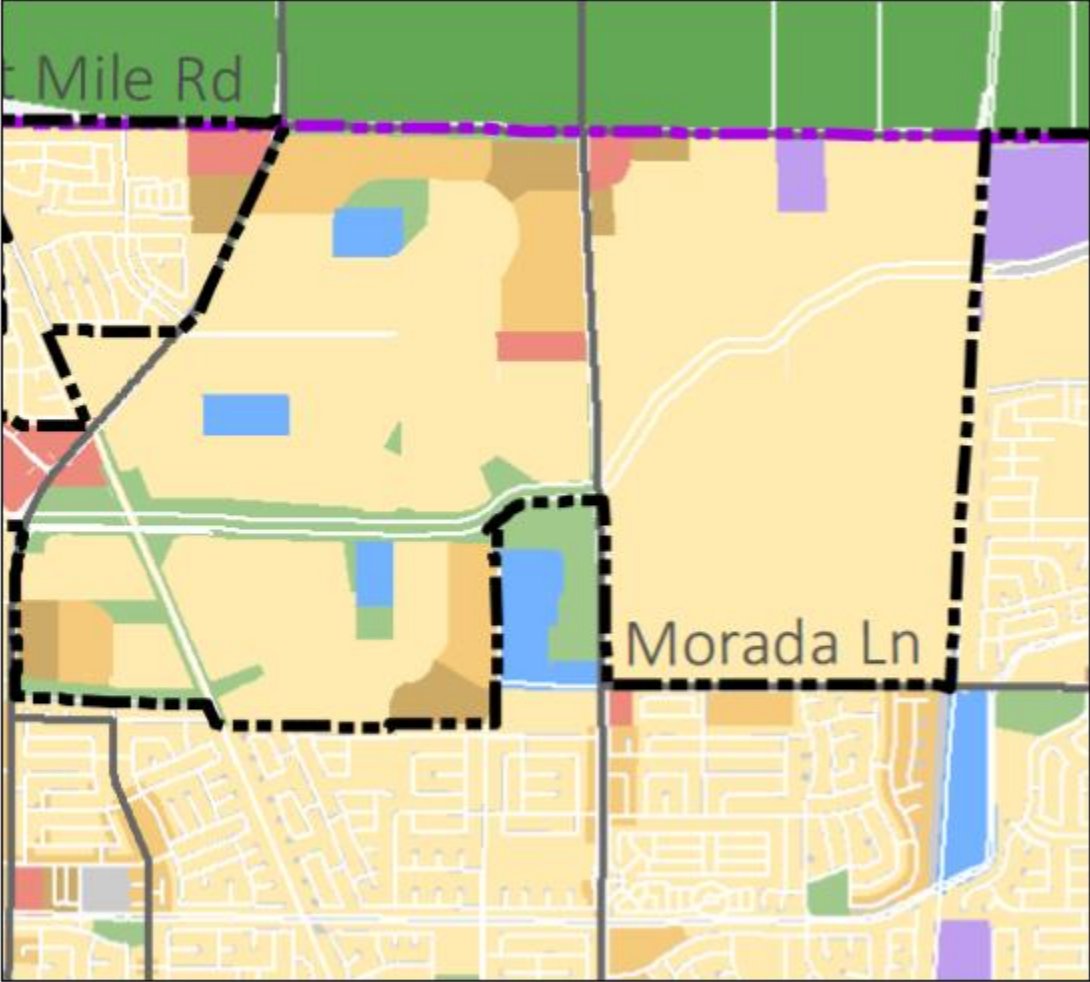

**From:** Gardner, Virginia@DPC  
**To:** [David Stagnaro](#)  
**Subject:** Comment Update, and Apparent Discrepancy on GPU DEIR Fig 3-4  
**Date:** Wednesday, August 08, 2018 1:47:20 PM  
**Attachments:** [image001.jpg](#)  
[image002.jpg](#)

---

Dave,

We will be offering comments to express some concern regarding the potential impact on maintaining viability of agriculture in the Primary Zone of the Delta from developing the western edge of the proposed “Economic and Education Enterprise” area. At the EIR workshop I mentioned the interest in suggesting inclusion of the National Heritage Area, but that can be considered independent of the General Plan Update cycle.

A06-01

Also, there is an apparent discrepancy between the Urban to OS/Ag figure (Fig 3-4) and the proposed GP Land Use Map at Wright-Elmwood Tract along Fourteen-Mile Slough – it appears that the eastern area that was previously “Residential Estate,” is re-designated OS/Ag based on a comparison of the existing and proposed Land Use Maps, but it doesn’t show up on the Urban to OS/Ag Changes Fig 3-4, at least not from what I can see. Just wanted to confirm that area of Residential Estate has in fact been changed to OS/Ag.

A06-02

Thanks!

VG  
Virginia G. Gardner  
Program Manager  
**DELTA PROTECTION COMMISSION**  
2101 Stone Blvd., Suite 240  
West Sacramento, CA 95691  
email: [virginia.gardner@delta.ca.gov](mailto:virginia.gardner@delta.ca.gov)  
office: (916) 375-4801  
cell: (805) 252-5385  
website: [www.delta.ca.gov](http://www.delta.ca.gov)



\*\* Learn more about events and things to do in the Delta: [www.VisitCADelta.com](http://www.VisitCADelta.com) \*\*



August 9, 2018

David Stagnaro  
Planning Manager  
City of Stockton Community Development Department

Re: Envision Stockton 2040 General Plan

Thank you for the opportunity to review the draft Envision Stockton 2040 General Plan. Reinvent South Stockton Coalition’s mission is to empower its residents to transform community through improving safety, education, housing, job creation, and health. As a community stakeholder with ongoing initiatives in the city’s historically underserved communities, we would like to submit the following comments on the General Plan.

A07-01

As most Stocktonians can affirm, the story of our community has always been a place of stark contrast and disparate expectations of opportunity. Simply stated, there exists a part of our community that has been victimized by the echoes of century-old policies of prejudice, deprived of the investment its residents are entitled to as members of our city. As our nation has once again awakened to the subject of equity, so too has Stockton looked at its own past injustices and begun to seek balance. It is in that work that we have seen both interest and resources shift toward those communities that we overlooked and neglected for so long.

Through the South Stockton Promise Zone effort, a uniquely effective coalition of investors and support structures has developed a plan to achieve transformative goals that were once thought of as implausible for a keystone block within South Stockton. The Airport Corridor, the center of commerce at the corner of 8<sup>th</sup> Street and Airport Way arguably once represented the culmination of our collective failings as a community to many, but it has now become the focal point of growth for this coalition and the outside investors the plan has attracted.

Members of the Reinvent South Stockton Coalition have invested in the future of this hub of community and enterprise and have leveraged that work to gain the investment necessary to realize their vision to create a thriving nexus for this community. Achieving this goal aligns with the goals of the General Plan to envision and create a healthy community by providing resources, services, opportunity, and the sense of pride and dignity necessary to create a sustainable and healthy community. A brief outline of that work, which has been spearheaded by RSSC’s Neighborhood Transformation initiative, is briefly summarized below:

A07-02

- **Who serves on the working group?**  
Affordable housing developers, public health partners, and other cross-sector Reinvent South Stockton Coalition members and residents interested in revitalizing this neighborhood
- **What is the group currently working on?**  
With the help of City Systems as a consultant, the Neighborhood Transformation working group is developing a South Stockton Promise Zone Community Vision, with a focus on the Airport Way Corridor. The project is a proactive response to decades of disinvestment and neglect in South Stockton. The effort is led by RSSC and its SSPZ partners and has been significantly shaped by



community input. The project has surveyed and engaged residents to establish a baseline understanding of community conditions. Partners are also soliciting public and private investment in the SSPZ, articulating the needs of residents in the SSPZ, and plan to consult with residents to finalize plan development along Airport Way.

- ***What is the status of the project?***

- Status of project: The working group is collaborating with the consultant on fine tuning methodology for assessing community conditions and resident access to commercial services and community amenities.
- Project next steps: Preparing and planning for community engagement and input; Collected data will be used to develop optimal scenario for development along Airport Way
- Estimated completion: End of 2018

**A07-02  
cont.**

Reinvent South Stockton Coalition believes that our work strongly aligns with the General Plan's Goal CH-2: Restored Communities to "restore disadvantaged communities to help them become more vibrant and cohesive neighborhoods with high-quality affordable housing, a range of employment options, enhanced social and health services, and active public spaces."

- Policy CH-2.1: Prioritize maintenance of streets and improvement of sidewalks, parks, and other infrastructure in areas of the city that historically have been comparatively underserved by public facilities.
  - RSSC Response: The Promise Zone project on 8<sup>th</sup> & Airport will help to identify improvements to walkability and accessibility to services for residents in an area of the city that has been underserved. RSSC requests to be included in efforts led by the city to implement this policy.
- Policy CH-2.2: Stimulate investment through partnerships with private property owners, neighborhood groups, health and housing advocates, non-governmental organizations and other community supporters.
  - RSSC Response: RSSC partners are proactively connecting with investors within the Stockton community (i.e. Community Medical Centers), foundations, CRA funding, private investors, etc. with the goal of achieving investment in South Stockton. RSSC requests that the city partner with RSSC on an initiative to stimulate investment in historically underserved communities in South Stockton, including efforts to market/recruit developers, as well as planning for Opportunity Zones.
- Policy CH 2.3: Focus on reducing the unique and compounded environmental impacts and risks in disadvantaged communities
  - RSSC Response: RSSC partners are working with the City on the Brownfield assessment and prioritizing both the environmental health and population health of the neighborhood in all stages of development. RSSC suggests continued partnership in order to align environmental remediation with efforts to restore the city's underserved communities.

**A07-03**



Thank you for the opportunity to comment. As the current Executive Director of Reinvent South Stockton Coalition, I have worked with this group on this project since its inception. I am transitioning out of Stockton into a new role, so if you have questions, please contact my RSSC colleague, Nathan Werth at [nwerth@rsscoalition.org](mailto:nwerth@rsscoalition.org) or 209-406-0730 for further details and clarification on this project.

A07-04

Sincerely,

A handwritten signature in blue ink, appearing to read 'Hector Lara', is positioned above the typed name.

Hector Lara  
Executive Director  
Reinvent South Stockton Coalition



SIERRA CLUB  
FOUNDED 1892

Delta-Sierra Group  
Mother Lode Chapter  
P.O. Box 9258, Stockton CA 95208

August 9, 2018

To: City of Stockton Community Development Department via email: David.Stagnaro@stocktonca.gov

Re: Envision Stockton 2040 DEIR Comments

Members of the Delta-Sierra Group Executive Committee spoke on various aspects of the Draft Environmental Impact Report and General Plan documents at the August 2, 2018 Planning Commission Public Hearing including Margo Praus, Paul Plathe, Richard Abood, and Mary Elizabeth. Additionally, Eric Parfrey spoke on behalf of Sierra Club California which coordinates conservation and political actions with the Sierra Club Chapters of which the Mother Lode Chapter which the Delta-Sierra Group belongs is included.

A08-01

These comments are meant to augment comments received.

On a point of order several Planning Commissioners mentioned that they were still reading the General Plan and followed up on a process question with regard to additional public input meetings that are planned to occur after August 10, 2018 that is the end of the 45 day comment period for the Draft Environmental Impact Report and draft General Plan – Envision 2040. Staff stated that 45 days is the minimum comment period but did not offer the Commissions the option which is within their purview to officially extend the comment period.

A08-02

Additionally, the notice of availability states that in addition to the electronic copy that there is a hard copy on file for public review at Cesar Chavez Central Library, 650 N El Dorado St., Stockton CA. On August 4, 2018 review at the Cesar Chavez library occurred and according to Kendra Johnson only the main DEIR was provided by Community Development Department staff. The DEIR paper copy provided did not include the referenced appendices and technical documents that were only available electronically.

**1.2.3 MITIGATION MONITORING**

The DEIR early on referenced the requirement for the City of Stockton to adopt a Mitigation Monitoring and Reporting Program intended to ensure the implementation of all mitigation measures adopted through the preparation of an EIR. The DEIR stated that the Mitigation Monitoring and Reporting Program for the proposed project will be completed as part of the environmental review process. Please include the Mitigation Monitoring and Reporting Program in the next draft of the EIR which would be near the end of the environmental review process. This is the criteria that will be used to evaluate environmental mitigation measures implementation.

A08-03

GHG-2 Implementation of the proposed project would not conflict with an applicable plan, policy, or regulation adopted for the purpose of reducing the emissions of GHGs.

The SJCOG RTP/SCS update was adopted June 28, 2018 which is prior to the adoption of Envision Stockton 2040 requiring updated analysis and language compliance in order to qualify for the Delta Plan: Mitigation and Monitoring Reporting Program exemption. A Certification of Consistency resulting from a comparison of the program document with the SJCOG RTP/SCS is required. The current DEIR analysis was based on the 2014 RTP/SCS and so the DEIR will require revision so that the contemporary analysis can be performed.

A08-04

**4.3 AIR QUALITY**

The DEIR should include more concrete summaries of the implementation of SJVUAPCD Rules. For example, the ETRIP program to implement rule 9410: how many employers in Stockton are required to submit VMT reduction plans and how many have submitted plans?

A08-05

Strengthen language for considering actions associated with Policy LU-1.1: Encourage retail businesses in mixed-use developments along regional transportation routes and in areas that serve local residents. Action LU-1.1.A: Requires specific design elements, Action LU-1.1.B: Evaluate the City’s parking policies, and amend the Development Code; but Action LU-1.1.C: Continue to study and consider repealing the “Big Box Ordinance” that was adopted in 2007, and if big-box stores are allowed in the future then require applicants to fund an analysis of economic and blight-inducement impacts of the proposed development.

**A08-06**

The DEIR should specifically reference the existing study documents regarding the repealing of the “Big Box Ordinance”.

**A08-07**

Policy TR 1.1 states “bicycles and pedestrians and vehicles for disabled travelers”. Are vehicles the general term for motorized, non-motorized wheelchairs or wheelchair accessible automobiles?

Policy TR 2.3 states “wheel” more frequently. Wheel should be changed to bicycle.

Policy SAF-4.2 “Encourage major employers to participate in a transportation demand management program (TDM) that reduces vehicle trips through approaches such as carpooling, vanpooling, shuttles, car-sharing, bike-sharing, end-of-trip facilities like showers and bicycle parking, subscription bus service, transit subsidies, preferential parking, and telecommuting”. The policy does not specify what is the definition of a major employer – if more than 100 employees commuting to a specific location then this is what the SJVUAPCD addresses in Rule 9410.

**A08-08**

Particulate matter associated with accumulated street dust has been reported to constitute as much as 85 percent of ambient airborne particulate matter (PM<sub>10</sub>) and re-entrainment of street dust is a major source of urban PM<sub>2.5</sub> and PM<sub>10</sub>, which have significant impacts on human health. Appropriate street cleaning methodologies can reduce road dust hazards that negatively impact air quality and storm water runoff quality. Discussions at special meetings to address trash included the suggestion that as a policy the city enacts regular citywide street cleaning with signage to prohibit parking on the sides of streets on particular days. We have several areas of Stockton that do not have regular street cleaning because cars are parked on the sides of streets that are being cleaned. Please include a policy in the final EIR that addresses street cleaning as a means to improve stormwater and air quality.

**A08-09**

Mitigation Measure AQ-2 includes policy to expressing forbidding “use of blowing devices”. Personal and commercial use of blowing devices contribute to poor air quality in our city. Request additional policy consideration for an educational program or incentive to use vacuuming devices to direct and capture materials which are currently been blown somewhere.

**A08-10**

Mitigation Measure AQ-3 includes “coordination to ensure that bus pad and shelter improvements...” should specify that these facilities do not result in increased idling by vehicles already traveling on the road as a result of a transit stop. Additional lanes pull out with signage will decrease idling of long ques of traffic or dangerous lane changes and increase bicycle safety by reducing transit bicycle conflicts.

**A08-11**

AQ-5 The DEIR mentioned several times that in the last several years CO hotspots have not been found in the city; however, in the area of Eight Mile Road a CO hotspot may be generated related to focused development in the northern area of the planning area. The DEIR distributed the net total daily vehicle trips throughout the EIR study area instead of focusing on regions where anticipated development is allowed in the 2040 horizon year.

“Anticipated development allowed under the proposed General Plan in the 2040 horizon year would result in approximately 2,091,100 average daily trips, which would be an increase of 547,300 total daily vehicle trips over existing conditions. However, distributing the net total daily vehicle trips throughout the EIR Study and region and by peak hour would result in smaller traffic volumes at the various intersections. Thus, implementation of the proposed General Plan and UMPS is not anticipated to produce the volume of traffic required to generate a CO hotspot. Therefore, implementation of the

**A08-12**



proposed General Plan and UMPS would not have the potential to substantially increase CO hotspots at intersections in the vicinity of the EIR Study Area, and impacts would be less than significant.”

A08-12  
cont.

The development resulting in increased daily vehicle trips is not distributed uniformly throughout the study area; therefore, additional characterization of air quality impacts where developed is planned is needed. Furthermore, the use of Bay Area air quality screening protocols does not seem appropriate since our weather patterns differ significantly. Use of a SJVUAPCD screening recommendations would be more appropriate.

A08-13

Mitigation Measure AQ-5 included reduction of onsite idling to reduce toxic air pollutants. Policy language should be included that commits the City of Stockton to developing in consultation with the SJVUAPCD an anti-idling campaign.

A08-14

**4.4 BIOLOGICAL RESOURCES**

BIO- 1. Since 57 percent of EIR study area is urbanized (41870 acres) several endangered plants and animals could be assisted in their survival by a mitigation measure that would establish development of native plant and animal resources within the community development department that would assist city residents with native plant propagation particularly assisting bee populations that are not covered by the SJMSCP. This mitigation measure would be in addition to those projects that require a landscape plan.

A08-15

Action SAF-2.4.C in the proposed General Plan directs the City to preserve waterways and floodplains for non-urban uses to maintain flood carrying capacity. Additionally, language should be included that commits the City of Stockton to enhance these environments where wildlife migration has been identified as feasible, such as the Calaveras River.

A08-16

Action LU-5.3.C maintains an agricultural conservation program by which the City will mitigate the loss of agricultural lands, some of which provide habitat to special status species. Is this a current program that will be maintained? If so, then a reference to program planning documents should be included in the DEIR.

A08-17

BIO-5 Implementation of the proposed project would not conflict with any local policies or ordinances protecting biological resources. Municipal Code 16.72.245 protects heritage trees. Our trees in general have not been maintained and frequently large limbs snap. A map of these heritage trees and discussion of how well the code is doing to protect these native trees should be included in the DEIR.

A08-18

**4.8 HAZARDS AND HAZARDOUS MATERIALS**

HAZ-1 Implementation of the proposed project would not create a significant hazard to the public or the environment through the routine transport, use, or disposal of hazardous materials. Action SAF-2.6.C directs the City to educate the public about household hazardous wastes and the proper methods of disposal, which will minimize risk from the routine use of household hazardous materials. The existing education effort fails to reach a large audience. At some point within the last year batteries and light bulbs were accepted at fire stations now evidently according to the city’s website batteries can now go in a clear plastic bag on top of the recycling cans and fluorescent light bulbs have to be driven to the county facility near the airport south of town (Th-Sat 9-3 pm). A City of over 300,000 should have more opportunities available for it’s citizens to deal with hazardous wastes and materials.

A08-19

**4.9 HYDROLOGY AND WATER QUALITY**

The DEIR stated:

“The CVRWQCB issued a region-wide MS4 Permit (Order No. R5-2016-0040) covering the entire Region, and covering storm drainage systems in cities as small as 10,000 population, in June 2016.3 The City of Stockton and San Joaquin County are permittees on the region-wide Permit. The City of Stockton and San Joaquin County will be updating their Stormwater Management Plan (City) and Stormwater Quality Control Criteria Plan (City and County) pursuant to the region-wide Permit, with completion anticipated in 2018. The

A08-20

City and County will enroll under this permit after completion of those documents.” According to Than, Ba, Deputy Director of Collections/Maintenance. Phone conversation with City of Stockton Municipal Utilities Department, August 1, 2017.

**A08-20  
cont.**

The City of Stockton entered into an MOU with San Joaquin to develop the plan and the status of the plan in this DEIR should have been updated within the last year.

***Surface Water and Groundwater***

According to the DEIR the City uses surface water as its primary water supply source, supplementing it with groundwater when insufficient surface water is available to meet water demands. Surface water comprised about two-thirds of City of Stockton Municipal Utility Department (COSMUD) water supplies in 2015, and is forecast to comprise about 75 percent of such supplies in 2040. Surface water is also used extensively for agricultural irrigation in the Stockton region. Groundwater underlying the City of Stockton Planning area is located in the Eastern San Joaquin Groundwater Subbasin which is critically overdrafted.

In December 2015 the City of Stockton Council approved the formation of the Groundwater Sustainability Agency (GSA) to encompass all of the City of Stockton for the purpose of developing a groundwater sustainability plan. In June 2017 the Eastern San Joaquin Groundwater Authority Joint Powers Authority held their first meeting. The City of Stockton GSA is one of 17 GSAs in The Eastern San Joaquin Groundwater Authority that are developing a Groundwater Sustainability Plan to address the critically overdrafted status of the Subbasin as well as other water quality and quantity concerns. The Eastern San Joaquin Groundwater Authority as well as the City of Stockton have public outreach requirements. The City of Stockton’s representatives have not been providing City Council or the City’s Water Advisory Group with updates on the status of plan development and meetings are frequently cancelled. The DEIR should include a characterization of the roles and responsibilities of the City of Stockton GSA.

**A08-21**

The DEIR stated that the Eastern San Joaquin Subbasin is recharged by water from sources including streams, percolation of rainfall and irrigation water, inflow from other groundwater basins, and intentional recharge at numerous facilities. Intentional recharge is conducted in recharge ponds and on some farm fields with compensation to landowners. A summary of these fluxes as well as a list of recharge ponds and funds paid to landowners should be included in the DEIR.

**A08-22**

Prior to the formation of the Eastern San Joaquin Groundwater Authority JPA the active a joint powers agency was the Eastern San Joaquin County Groundwater Basin Authority (GBA). The GBA has not met for over a year and the GBA’s main project task which was the development and implementation of the Eastern San Joaquin Integrated Regional Water Management Plan will be overseen by the San Joaquin County Water Advisory Commission.

**A08-23**

Policy SAF-3.2: Protect the availability of clean potable water from groundwater sources. Revise to include from groundwater contamination sources.

**A08-24**

HYDRO-2.1 Implementation of the proposed project would not substantially deplete groundwater supplies. Groundwater supplies are forecast to increase from about 13,368 afy in 2015 to 29,840 afy in 2040. Available groundwater supplies may not increase if curtailment of pumping is a management tool to address the Eastern San Joaquin Groundwater Subbasin critically overdrafted state.

**A08-25**

Additionally, Table 4.9-2 included below indicates that significant volumes of surface water will be needed. Should the State of California Water Fix be implemented the surface water sources will have greater quality issues to address. There should be a discussion in the DEIR about the COSMUD extraction of delta water which is contingent on discharge volumes from the City of Stockton Waste Water Treatment Plant (WWTP).

**TABLE 4.9-2 EXISTING AND FORECAST WATER SUPPLIES BY SOURCE, EIR STUDY AREA**

| Source  |   | 2015           |                           | 2040           |                           |
|---|---|----------------|---------------------------|----------------|---------------------------|
|   |   | Supplies (afy) | Percent of Total Supplies | Supplies (afy) | Percent of Total Supplies |
| Purchased water – Calaveras, Stanislaus, and Mokelumne rivers | City of Stockton Municipal Utilities Dept. (COSMUD) | 15,350         | –                         | 24,000         | –                         |
|   | California Water Service Company (CWSC)             | 8,787          | –                         | 19,000         | –                         |
|   | <b>Total</b>  | <b>24,137</b>  | <b>51%</b>                | <b>43,000</b>  | <b>35%</b>                |
| Surface Water (San Joaquin Delta)                             | COSMUD  | 9,428          | 20%                       | 50,000         | 41%                       |
|   | COSMUD  | 6,740          | –                         | 6,740          | –                         |
| Groundwater   | CWSC  | 6,628          | –                         | 23,100         | –                         |
|   | <b>Total</b>  | <b>13,368</b>  | <b>28%</b>                | <b>29,840</b>  | <b>24%</b>                |
| <b>Total Water Supplies</b>                                   |   | <b>46,933</b>  | <b>100%</b>               | <b>122,840</b> | <b>100%</b>               |

Note: afy = acre-feet per year  
 Sources: California Water Service Company (CWSC) Stockton District. 2016. 2015 Urban Water Management Plan.  
 City of Stockton. 2016. 2015 Urban Water Management Plan.

**A08-25 cont.**

The finding of less-than significant impact cannot be made based on information submitted in the DEIR. The increased water supplies needed are not readily available nor will overall water conservation and efficiency requirements reduce demand to current supply levels. These considerations were used in developing the referenced urban management plan estimates before beginning development of the Groundwater Sustainability Plan to address our critically overdrafted basin. Furthermore, if downstream flows are required to mitigate Delta impacts those additional surface water quantities purchases may not be available.

HYDRO-2.2 Implementation of the proposed project would not substantially interfere with groundwater recharge. The DEIR groundwater recharge impacts would be less than significant after implementation of BMPs required by the City of Stockton. Areas within the planning sphere that have a high potential for recharge<sup>1</sup> and the results of existing recharge projects undertaken by the City of Stockton should be analyzed particularly as recharge ponds have been identified as a means to reduce delta brackish water intrusion due to reduced groundwater levels. Additional analysis of this impact is needed in the DEIR.

**A08-26**

Mitigation Measure HYDRO-5: Complete a citywide storm drainage master plan, including hydrologic and hydraulic models for existing land use conditions and for the land uses anticipated in 2040 under the proposed General Plan. A time frame for this mitigation measure is essential particularly since there is already localized flooding resulting from gutter obstructions and under-sized facilities.

**A08-27**

HYDRO-6 Implementation of the proposed project would not otherwise substantially degrade water quality. A description of the City of Stockton’s 2017 stormwater quality should be included in the DEIR because no substantive changes are being proposed and if stormwater quality criteria are exceeded additional measures will be necessary and should be included as mitigation in the DEIR.

**A08-28**

HYDRO-7 Implementation of the proposed project would place housing within a 100-year flood hazard area as mapped on a federal Flood Hazard Boundary or Flood Insurance Rate Map or other flood hazard delineation map. The proposed General Plan would designate approximately 155 acres of vacant land in the 100-year flood zone for residential use, and would re-designate approximately 173 acres of land from other land uses to residential within the 100-year flood zone. According to the DEIR approximately 2,000 residential units could be constructed within the 100-year flood zone. Mitigation by property owners and the City of Stockton to aid

**A08-29**

<sup>1</sup> <https://casoilresource.lawr.ucdavis.edu/sagbi/>

in funding of levees to certify compliance with SB5 creates bad policy. Those acres should be set aside for nature area or facilities that can accommodate flood waters not homes.

A08-29  
cont.

**4.10 LAND USE AND PLANNING**

1500 acres of parks in 62240 acres within the DEIR study area is inadequate. The parks list should have totals for each planning area or neighborhood so that the equity of distribution could be assessed.

A08-30

**4.11 NOISE**

NOISE-1 The proposed project would not expose people to or generate noise levels in excess of standards established in the General Plan or the Municipal Code, and/or the applicable standards of other agencies. The DEIR TABLE 4.11-8 EXISTING ROADWAY NOISE ANALYSIS did not analyze distances when 75 decibels were exceeded, yet in TABLE 4.11-10 LAND USE COMPATIBILITY FOR COMMUNITY NOISE ENVIRONMENTS Infill is allowed 80 db, the same as a mining operation, and the same as included in the 2035 General Plan. We can do better. The data included in the DEIR do not support allowing for noise degradation to that level for infill. Table 4.11-10 should be updated to decrease the noise allowance for infill to be something more reasonable for what will be expected in infill areas. The long-term noise monitoring station noted Figure 4.11-2 located near I-5 and Hwy 4 exceeded 100 decibels in 1 hour within 24 hours.

A08-31

**4.12 POPULATION AND HOUSING**

The DEIR included two projections the 2040 horizon-year projection for the proposed General Plan includes the following:

- 40,900 new dwelling units
- 132,200 new residents
- 63,300 new jobs
- 13.8 million square feet of new commercial space and office space
- 35.6 million square feet of new industrial space

A08-32

By comparison, SJCOG projects the following between 2015 and 2040:

- 48,270 new dwelling units
- 153,530 new residents
- 41,030 new jobs

These are very different and a clear rationale for selecting one estimate over another was not included in the DEIR.

Review of previous housing reports indicated that there is a greater need in Stockton to house single mothers with children, the disabled, and the elderly. The ratio in some areas for multifamily homes is low to non-existent.

A08-33

**4.13 PUBLIC SERVICES AND RECREATION**

City of Stockton Police services include Code Enforcement and Animal Services both of which provide valuable services to the community at large.

A08-34

The DEIR stated that the response time for priority one calls are greater than 5 minutes in the northern area of Stockton. According to changes in the North/South development additional mitigation is needed to pay for Police and Fire facilities located in areas outside of the core area.

A08-35

Parks and recreational facilities and programs are lacking in Stockton with 1500 acres for over 300,000 residents within the city limits. Park acreage by planning area, neighborhood, census district or zip code is needed to evaluate equity issues related to the distribution and maintenance of facilities.

A08-36

The Infill in the Central area will require additional funding sources since those projects will be of a smaller acreage size and not trigger the mitigation fee. The DEIR should include an analysis of infill projects and recreational facilities available to residents and visitors to the downtown core

A08-37

Thank you for your consideration. Please contact us if we can answer any questions regarding the comments expressed herein.

Sincerely,



Mary Elizabeth, M.S., R.E.H.S.  
Delta Sierra Group Conservation Chair

**DELTA PROTECTION COMMISSION**

2101 Stone Blvd., Suite 240  
West Sacramento, CA 95691  
(916) 375-4800 / FAX (916) 376-3962  
[www.delta.ca.gov](http://www.delta.ca.gov)



Received  
AUG 14 2018  
City of Stockton  
Community Development

- Skip Thomson, Chair*  
Solano County Board of Supervisors
- Oscar Villegas, Vice Chair*  
Yolo County Board of Supervisors
- Don Nottoli*  
Sacramento County Board of Supervisors
- Chuck Winn*  
San Joaquin County Board of Supervisors
- Diane Burgis*  
Contra Costa County Board of Supervisors
- Ronald Kott*  
Cities of Contra Costa and Solano Counties
- Christopher Cabaldon*  
Cities of Sacramento and Yolo Counties
- Susan Loftus*  
Cities of San Joaquin County
- George Biagi, Jr.*  
Central Delta Reclamation Districts
- Justin van Loben Sels*  
North Delta Reclamation Districts
- Robert Ferguson*  
South Delta Reclamation Districts
- Brian Annis*  
CA State Transportation Agency
- Karen Ross*  
CA Department of Food and Agriculture
- John Laird*  
CA Natural Resources Agency
- Brian Bugsch*  
CA State Lands Commission
- Ex Officio Members*
- Honorable Susan Talamantes Eggman*  
California State Assembly
- Honorable Cathleen Galgiani*  
California State Senate

August 10, 2018  
  
David Stagnaro, Planning Manager  
City of Stockton  
Community Development Department  
345 N. El Dorado Street  
Stockton, CA 95202

Re: SCH 2017052062, Draft Environmental Impact Report, Envision Stockton 2040 General Plan Update and Utility Master Plan Supplements

Dear Mr. Stagnaro,

Thank you for providing the Delta Protection Commission (Commission) the opportunity to review the Envision Stockton 2040 General Plan Update and Draft Environmental Impact Report (Project, or DEIR).

Proposed projects within the Primary Zone of the Legal Delta must be consistent with the Commission’s Land Use and Resource Management Plan (LURMP). Pursuant to PRC Section 29770(d), the Commission may provide comments on proposed projects in the Secondary Zone that have the potential to affect the resources of the Primary Zone. Portions of the City of Stockton are located within the Secondary Zone of the Legal Delta. Therefore, as a general comment, we recommend that the Land Use and Planning section of the EIR (Chapter 4.10), Environmental Setting, Regulatory Framework (section 4.10.1.1) listing of Regional Regulations include the Delta Protection Commission Land Use and Resource Management Plan.

After careful review, more specifically we find that the Project as proposed raises some concerns relative to the new “Economic and Education Enterprise” designation north of West Eight Mile Road and west of Interstate 5. Future development at the western end of the proposed area, if not carefully planned, could adversely impact the viability of the adjacent agricultural lands to the west, within the Primary Zone. The designation would affect two parcels in this area that are in active Williamson Act contracts.

These impacts are captured in the EIR Impacts AG-1 and AG-2:

Impact AG-1: Implementation of the proposed project would convert farmlands of concern under CEQA to non-agricultural use.

A09-01

A09-02

A09-03

Impact AG-2: Implementation of the proposed project would conflict with an existing Williamson Act contract.

The DEIR concludes (pp 4.2-12 and 4.2-14):

Because these farmland areas are located near existing urbanized areas, they may not be viable for agricultural operations due to conflicts with nearby urbanized areas. The only way to mitigate this impact would be to prohibit any development on farmland of concern.

The DEIR finds both Impacts AG-1 and AG-2 to be significant and unavoidable.

We believe this oversimplifies a complex issue, and creates a false, "all-or-nothing" dichotomy that can lead to increasing conversion of farmland areas that are "near existing urbanized areas" by assuming they will become non-viable. Commission staff suggest this General Plan Update provides an opportunity to take a more balanced approach.

To optimally preserve the viability of the agricultural lands in the Primary Zone, the area north of West Eight Mile Road and within vicinity of the Primary Zone boundary should be designated Open Space/Agriculture. However, the Commission also has a mission to protect, maintain, enhance and enrich the quality of the Delta environment and economy. Should the City determine that, on balance, designation of the area north of West Eight Mile Road as Economic and Education Enterprise is essential to its economic needs, the principles of the following LURMP policies, or the policies themselves, should be incorporated into the General Plan and DEIR analysis:

Land Use P-3: New non-agriculturally oriented residential, recreational, commercial, habitat, restoration, or industrial development shall ensure that appropriate buffer areas are provided by those proposing new development to prevent conflicts between any proposed use and existing adjacent agricultural parcels. Buffers shall adequately protect integrity of land for existing and future agricultural uses and shall not include uses that conflict with agricultural operations on adjacent agricultural lands. Appropriate buffer setbacks shall be determined in consultation with local Agricultural Commissioners, and shall be based on applicable general plan policies and criteria included in Right-to-Farm Ordinances adopted by local jurisdictions.

Land Use P-7: New structures shall be set back from levees and areas that may be needed for future levee expansion consistent with local reclamation district regulations and, upon adoption, with the requirements to be identified in the California Department of Water Resources Central Valley Flood Control Plan.

A09-03  
cont.

A09-04

Agriculture P-2: Conversion of land to non-agriculturally-oriented uses should occur first where productivity and agricultural values are lowest.

Agriculture P-4: Support agricultural programs that maintain economic viability and increase agricultural income in accordance with market demands, including but not limited to wildlife-friendly farming, conservation tillage and non-tillage.

Agriculture P-5: Local governments shall encourage implementation of the necessary plans and ordinances to: maximize agricultural parcel size; reduce subdivision of agricultural lands; protect agriculture and related activities; protect agricultural land from conversion to non- agriculturally-oriented uses. An optimum package of regulatory and incentive programs could include: (1) an urban limit line; (2) minimum parcel size consistent with local agricultural practices and needs; (3) strict subdivision regulations regarding subdivision of agricultural lands to ensure that subdivided lands will continue to contain agriculturally-oriented land uses; (4) require adequate buffers between agricultural and non-agricultural land uses particularly residential development outside but adjacent to the Primary Zone; (5) an agriculture element of the general plan; (6) a Right-to-Farm ordinance; and (7) a conservation easement program.

Agriculture P-9: Support agricultural tourism and value-added agricultural production as a means of maintaining the agricultural economy of the Delta.

**A09-04  
cont.**

Thank you for your consideration of our comments. Please contact Virginia Gardner, Program Manager, at 916-375-4801 for any questions regarding the comments provided.

Sincerely,

  
Erik Vink  
Executive Director

Cc: Susan Lofthus, Commission member and City of Stockton Council Member





980 NINTH STREET, SUITE 1500  
SACRAMENTO, CALIFORNIA 95814  
HTTP://DELTACOUNCIL.CA.GOV  
(916) 445-5511

**DELTA STEWARDSHIP COUNCIL**  
*A California State Agency*

August 10, 2018

David Stagnaro  
Planning Manager  
City of Stockton  
425 North El Dorado Street  
Stockton, CA 95202  
[David.Stagnaro@stocktonca.gov](mailto:David.Stagnaro@stocktonca.gov)

**Chair**  
Randy Fiorini

**Members**  
Frank C. Damrell, Jr.  
Michael Gatto  
Maria Mehranian  
Susan Tatayon  
Skip Thomson  
Ken Weinberg

**Executive Officer**  
Jessica R. Pearson

**RE: Comments on Envision Stockton 2040 General Plan Update and Draft Environmental Impact Report for the General Plan Update and Utility Master Plan Supplements**

Dear Mr. Stagnaro:

Thank you for the opportunity to review and provide comments on the Draft Envision Stockton 2040 General Plan Update and Draft Environmental Impact Report (Draft EIR) for the General Plan Update and Utility Master Plan Supplements. Delta Stewardship Council (Council) staff also appreciated the opportunity to attend a workshop on the General Plan Update on July 30, 2018 and to discuss certain aspects of the General Plan Update and Draft EIR with you via telephone on August 6, 2018.

The Council is an independent State of California agency established by the Sacramento-San Joaquin Delta Reform Act of 2009 (SBX7 1; Delta Reform Act). The Council is charged with furthering California's coequal goals for the Delta through the adoption and implementation of the Delta Plan, regulatory portions of which became effective on September 1, 2013.

As stated in the Delta Reform Act, the State has "coequal goals' (which) means two goals of providing a more reliable water supply for California and protecting, restoring, and enhancing the Delta ecosystem. The coequal goals shall be achieved in a manner that protects and enhances the unique cultural, recreational, natural resource, and agricultural values of the Delta as an evolving place" (Water Code section 85054).

Through the Delta Reform Act, the Council was directed to review and provide timely advice to local and regional planning agencies regarding the consistency of local and regional planning documents with the Delta Plan. The Council's input includes, but is not limited to, reviewing the consistency of local and regional planning documents with the ecosystem restoration needs of the Delta and reviewing whether the lands set aside for natural resource protection are sufficient to meet the Delta's ecosystem needs. (Water Code section 85212).

A10-01

*"Coequal goals" means the two goals of providing a more reliable water supply for California and protecting, restoring, and enhancing the Delta ecosystem. The coequal goals shall be achieved in a manner that protects and enhances the unique cultural, recreational, natural resource, and agricultural values of the Delta as an evolving place."*

### Covered Action Status

Through the Delta Reform Act, the Council was granted specific regulatory and appellate authority over certain actions of State or local public agencies that take place in whole or in part in the Delta. To do this, the Delta Plan contains a set of regulatory policies with which State and local agencies are required to comply. The Delta Reform Act specifically established a certification process for compliance with the Delta Plan. This means that State and local agencies that propose to carry out, approve, or fund a qualifying action in whole or in part in the Delta, called a "covered action," must certify that this covered action is consistent with the Delta Plan and must file a certificate of consistency with the Council that includes detailed findings.

As noted in the Draft General Plan, most of the western portion of Stockton's Planning Area is located within the Legal Delta, and thus subject to State oversight through the Delta Plan. The City of Stockton (City) has identified the need for the General Plan to be consistent with the Delta Plan (Draft General Plan, p. 3-17). The City has also identified that the Delta Plan includes a requirement for consistency findings for covered actions, which include the proposed General Plan (Draft EIR, pp. 4.2-3, 4.4-6, 4.10-4). The City also acknowledges the role of the Delta Plan's policies to address flood protection for residential development and limit encroachment in floodplains (Draft EIR, p. 4.9-7).

It should be noted that the Delta Reform Act establishes specific criteria and categories for exempting actions from the Council's regulatory authority. One of these exemptions is for actions within the Secondary Zone of the Delta that a metropolitan planning organization determines are consistent with its sustainable communities strategy (SCS). Such proposed actions are not covered actions regulated by the Council (Water Code section 85057.5(b)(4)).

The Draft EIR analyzes consistency with the San Joaquin Council of Governments' (SJCOG) 2014 Regional Transportation Plan/Sustainable Communities Strategy (RTP/SCS) (Draft EIR, p. 4.10-18). An updated 2018 RTP/SCS was adopted by SJCOG on June 28, 2018. With respect to land use, the 2018 RTP/SCS is consistent with the Delta Plan. The City may request an evaluation of the updated General Plan's consistency with SJCOG's 2018 RTP/SCS. If SJCOG determines that the updated General Plan is consistent, the proposed project would be exempt from the Council's covered action process.

Additional information on covered actions and the certification process can be found on the Council website, <http://deltacouncil.ca.gov/covered-actions>.

A10-02

### Comments on the Draft General Plan

Based on our review, Council staff has not identified any specific inconsistency between the Draft General Plan and the Delta Plan pursuant to Water Code section 85212. In fact, several General Plan policies align with the Delta Reform Act and the Delta Plan, including the following:

- **General Plan Land Use Designations.** Council staff is pleased to see that the General Plan Update will re-designate areas depicted as “Village” in the southern portion of the Planning Area to “Open Space/Agriculture”. The Council supports this proposed change, which contributes to consistency between the General Plan and the Delta Plan.

Other land use designation changes in the Planning Area within the secondary zone of the Legal Delta appear to align with **Delta Plan Policy DP P1, Locate New Urban Development Wisely** (23 Cal. Code of Regs. section 5010). This includes redesignation of areas north of the City Limits from “Village” to “Economic and Education Enterprise,” as the subject area was previously designated for development in the City’s General Plan as of the date of the Delta Plan’s adoption (May 16, 2013).

- **Climate Change.** The Council supports General Plan Policy CH-5.1A which outlines the City’s intention to conduct a “comprehensive climate change vulnerability assessment to inform the development of adaptation and resilience policies and strategies”. In a closely related effort, over the next couple of years, the Council will be undertaking a *Climate Change Vulnerability Assessment and Adaptation Strategy for the Sacramento – San Joaquin Delta* that seeks to incorporate stakeholder input, best available science, and identifies specific high-priority options for adapting to the changing climate. Council staff look forward to working with the City as a collaborative stakeholder in this process.

Council staff requests the City incorporate the following technical correction to the Draft General Plan regarding the Delta Plan:

- Land Use Element, p. 3-17, second paragraph. Please change the reference to the “Delta Reform Plan” to the “Delta Plan.”

### Comments on the Draft EIR

Council staff appreciates the City’s consideration and incorporation of comments we offered on the Notice of Preparation (NOP) for the 2040 General Plan Update and Utility Master Plan Supplements EIR in a letter dated June 22, 2017.

Council staff notes that the City evaluates the potential for conflict with the Delta Plan within the Draft EIR in the discussion of Impact LU-2, on p. 4.10-23. The analysis focuses on how

A10-03

A10-04

A10-05

David Stagnaro  
City of Stockton  
August 10, 2018  
Page4

General Plan goals SAF-3 (Sustain Clean and Adequate Water Supplies) and LU-5 (Protect, Maintain, and Restore Natural and Cultural Resources) and associated policies support the coequal goals. The analysis also identifies that, as discussed above, the proposed General Plan does not allow new residential, commercial, or industrial development in the Delta that was not already allowed in the existing 2007 General Plan, noting consistency with Delta Plan Policy **DP P1**. The City concludes that implementation of the proposed General Plan policies and actions would support, rather than conflict with the Delta Plan. This information will be useful for the City to present as part of the record accompanying a certification of consistency with the Delta Plan, should it be determined that the General Plan Update is a covered action.

A10-05  
cont.

### Closing Comments

We encourage the City to continue early consultation with Council staff and to work collaboratively with SJCOG, as appropriate, to discuss the consistency certification process for the General Plan Update. Continued consultation is an important step to ensure consistency between the 2040 General Plan and the Delta Plan, so that the two plans are complementary and serve to protect the Delta. Please contact Kate Anderson of my staff at (916) 445-5028 or [kate.anderson@deltacouncil.ca.gov](mailto:kate.anderson@deltacouncil.ca.gov) with any questions, comments, or concerns.

A10-06

Sincerely,

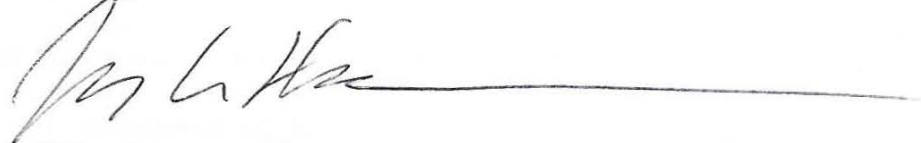

Jeff Henderson, AICP  
Deputy Executive Officer  
Delta Stewardship Council



San Joaquin Bike Coalition  
114 N. San Joaquin Street  
Stockton, CA 95202

---

August 10, 2018

Mr. David Stagnaro, AICP  
Community Development Department  
345 N. El Dorado Street  
Stockton, CA 95202

**RE: Envision Stockton 2040 Draft General Plan and Environmental Impact Report**

Dear Mr. Stagnaro,

On behalf of the San Joaquin Bike Coalition, I am writing to share our comments on the City of Stockton Draft General Plan and Environmental Impact Report. We appreciate the effort and outreach that went in to this document, which largely indicates a vast improvement on previous General Plan efforts, and how it supports a shift towards enhanced bikeability and walkability for residents of the City of Stockton.

A11-01

There are a few areas which, with minimal attention, we believe could strengthen the overall impact of the Plan if modified.

- **Support the Infill Focus Alternative for the General Plan, which is the environmentally superior alternative to the currently proposed General Plan.** We believe our city needs to grow upwards before we grow outwards. Expanding the overall footprint of the city will stretch transportation resources (among others) and decrease the feasibility of bicycle commuting from the outskirts of the City to major employment centers. SJBC participated in the comprehensive public outreach that took place, and find it concerning that the proposed General Plan footprint and development north of Eight Mile Road does not appear to take into consideration the overall public preference towards the Infill Focus Alternative.
- **Emphasize planning decisions that support overall mode shift and transportation choice by planning for people over vehicles.** We support the shift to using alternative models to Level of Service to analyze overall roadway efficiency, such as Vehicle Miles Travelled. It is our opinion that supporting transportation choice by building bicycle and pedestrian facilities will, over time, have a positive impact on property value, economic development, quality of life, and air quality. The current Level of Service measures used to assess impact do not appear to take into consideration these qualities beyond simply the efficiency with which a car can travel.

A11-02

A11-03

---

*“A vibrant cycling culture within the communities of San Joaquin County,  
where cycling is a safe and preferred method of transportation and recreation.”*

**[www.sibike.org](http://www.sibike.org)**



San Joaquin Bike Coalition  
114 N. San Joaquin Street  
Stockton, CA 95202

---

- **Address the shortage of and need for safe bicycle parking in already established areas of the city.** Identified as a major issue of concern in the recently adopted Bicycle Master Plan, bicycle parking is nearly nonexistent in much of the existing footprint of Stockton. While the draft EIR appears to mandate bicycle parking in new developments, it does not clearly address the issue of the current shortage.

A11-04

We appreciate the time and effort from both the public and City staff that has gone into this planning process. With the aforementioned changes, we would be happy to place our support behind the General Plan as it supports the City's comprehensive Bicycle Master Plan and SJBC's vision of a community where bicycling is a safe and preferred method of transportation and recreation. Thank you for your consideration.

A11-05

Sincerely,

**Kari McNickle**  
*Board President*  
*San Joaquin Bike Coalition*

---

*"A vibrant cycling culture within the communities of San Joaquin County,  
where cycling is a safe and preferred method of transportation and recreation."*

[www.sibike.org](http://www.sibike.org)



SAN JOAQUIN COUNCIL OF GOVERNMENTS

555 E. Weber Avenue • Stockton, California 95202 • P 209.235.0600 • F 209.235.0438 • www.sjcog.org

August 10, 2018

Mr. David Stagnaro, AICP
Community Development Department
345 N. El Dorado Street
Stockton, CA 95202

Robert Rickman
CHAIR

Doug Kuehne
VICE CHAIR

Andrew T. Chesley
EXECUTIVE DIRECTOR

Member Agencies
CITIES OF
ESCALON,
LATHROP,
LODI,
MANTECA,
RIPON,
STOCKTON,
TRACY,
AND
THE COUNTY OF SAN
JOAQUIN

Subject: SJCOG Comments on Envision Stockton 2040 General Plan and DEIR

Dear Mr. Stagnaro,

Thank you for the opportunity to review the Draft Envision 2040 General Plan Update and associated Draft Environmental Impact Report. As the County's designated Regional Transportation Planning Agency (RTPA), Metropolitan Planning Organization (MPO), Congestion Management Agency (CMA), Airport Land Use Commission (ALUC), and Travel Demand Management Program (Dibs), the San Joaquin Council of Governments (SJCOG) has the following comments:

A12-01

COMMENTS ON 2040 ENVISION STOCKTON GENERAL PLAN DEIR

RTPA/MPO's Review

SJCOG has analyzed Section 4.14 Transportation and Traffic of the DEIR and the associated appendices C, E, and F. SJCOG is supportive of the multimodal focus of the future transportation network envisioned by the 2040 General Plan. SJCOG suggests a meeting with City of Stockton to confirm open-to-traffic dates for projects identified in the Technical Memorandum, and to determine whether any modifications to the Regional Model are required. We believe that any necessary modifications can be dealt with via a Regional Transportation Plan amendment or through the adoption of the 2022 Regional Transportation Plan, depending upon the open-to-traffic dates associated with network improvements.

A12-02

Congestion Management Agency's Review

As noted on page 4.14-23 of the DEIR, "SJCOG is the designated Congestion Management Agency (CMA) for San Joaquin County. As such, they are required to maintain the State-mandated Regional Congestion Management Program (RCMP) for roadways within the county. The LOS Standard for RCMP facilities is LOS D. If a CMP segment operates worse than LOS E (i.e., LOS F), then the jurisdiction in which the segment is located must prepare a deficiency plan.

A12-03

RCMP facilities within the EIR Study Area include: Interstate 5, State Route 99, State Route 4, State Route 88, State Route 26, Eight Mile Road, Hammer Lane, March Lane, Sperry Road, French Camp Road, Trinity Parkway, Thornton Road, Pacific Avenue, West Lane, Airport Way, Mariposa Road, and Austin Road."

While the DEIR addressed various areas within the City of Stockton “to reduce the severity of potential LOS impacts,” found on pages 2-23 to 2-27, on page 4.14-23, the DEIR did not note Lower Sacramento Road, Arch Road, Navy Drive, Roth Road, Jack Tone Road, and Matthews Road under the list of RCMP facilities. All of these facilities lie within the General Plan Area, identified in the Notice of Availability. SJCOG recommends that impacts to these facilities be analyzed and incorporated into the Final Environmental Impact Report.

A12-03  
cont.

### Airport Land Use Commission’s Review

The Envision Stockton 2040 General Plan DEIR addressed Stockton Metropolitan Airport within the “Hazards and Hazardous Materials” section. As noted in our comment letter on the Notice of Preparation dated June 22, 2017, the proposed Stockton Sphere of Influence is located with the airport influence areas (AIA) of Lodi Airpark and Kingdon Executive Airport. SJCOG recommends the DEIR be revised to address potential impacts to the Lodi Airpark and Kingdon Executive Airport. The General Plan Planning Area lies within all the safety zones of Lodi Airpark and the following safety zones of Kingdon Executive Airport: Airport Influence Area (AIA), Traffic Pattern Zone (TPZ), Outer Approach / Departure Zone (OADZ), Inner Turning Zone (ITZ), Inner Approach / Departure Zone (IADZ), and Runway Protection Zone (RPZ). Please reference the 2018 San Joaquin County Airport Land Use Compatibility Plan (ALUCP) (<https://www.sjcog.org/ALUC>).

A12-04

## COMMENTS ON 2040 ENVISION STOCKTON GENERAL PLAN

### Congestion Management Agency’s Review

As noted on page 4-4 of the Draft General Plan, “*The San Joaquin Council of Governments (SJCOG) coordinates transportation planning and financing for the region and administers regional plans that promote sustainable growth, including the Regional Transportation Plan & Sustainable Communities Strategy that guides funding and policy decisions, the Regional Congestion Management that identifies regionally significant roadways, and the Smart Growth Transit-Oriented Development Plan that promotes transit-friendly land use planning and development.*”

SJCOG suggests revising this statement as follows: “*The San Joaquin Council of Governments (SJCOG) coordinates ... .., the Regional Congestion Management **Program** that identifies regionally significant roadways ...*”

SJCOG recommends the following segments be added to Action TR-4.1A, under “*Strive for different LOS standards along the following corridors due to physical constraints that limit improvements that can be constructed*”:

A12-05

- Eight Mile Road (I-5 to Thornton Road) – LOS F
- Arch Airport Road (SR-99 to Airport Way) – LOS F
- SR-4 (Fresno Avenue to Navy Drive/Stockton Street) – LOS F
- I-5 (Hammer Lane to Eight Mile Road) – PM LOS E
- SR-99 (Wilson Way to Hammer Lane) – PM LOS E
- SR-99 (Cherokee Road to Wilson Way) – LOS F
- SR-99 (SR-88 to Cherokee Road) – LOS F



These segments were determined to be operating at deficient LOS as of the 2016 SJCOG RCMP Monitoring Report.

SJCOG requests to be included as a stakeholder when the TIA Guidelines are updated as noted in Action TR-4.2B. We would like to review these updates for consistency with the RCMP and other regional plans.

### Airport Land Use Commission's Review

As noted on Page 4-5 of the Draft General Plan, "POLICY TR-1.3: Facilitate expanded port and airport operations, service, and development as travel and goods movement assets to the community and sources of employment growth. (TC-7, TC-8)

- *Action TR-1.3A - Protect the Airport and related aviation facilities from encroachment by ensuring that all future development within the Airport Influence Area (AIA) is consistent with the policies adopted by the San Joaquin County Airport Land Use Commission (ALUC), except in cases where the City Council concludes that project approval would provide for the orderly development of the Airport and the areas surrounding it while protecting the public health, safety, and welfare by minimizing the public's exposure to excessive noise and safety hazards."*

SJCOG assumes the exception is based off the ALUC Overrule policy within both 2018 Stockton Metropolitan (SM) (page 3-13) and San Joaquin County (SJC) Airport Land Use Compatibility Plan (ALUCP) (page 3-9).

*As noted on Page 4-7 of the Draft General Plan, "Action TR-1.3B - Where substantial development already exists within the AIA and is incompatible with ALUC policies, only allow additional infill development of similar land uses if projects meet all of the following criteria to be an infill project:*

- *The proposed project does not otherwise increase the intensity and/or incompatibility of use through use permits, density transfers, or other strategies. (LU-6.4) (Page 4-7)*

SJCOG requests clarity on Action TR-1.3B eligibility criteria #3, "*The proposed project does not otherwise increase the intensity and/or compatibility of use through use permits, density transfers, or other strategies (page 4-7).*" SJCOG recommends the inclusion of all criteria, not previously mentioned in Policy TR-1.3A of 2018 ALUCP (2018 SMALUCP, Page 3-26 to 3-27 & 2018 SJCALUCP, Page 3-17 to 3-18).

SJCOG recommends the inclusion of FAA notification requirement, as found in page 3-40 of SMALUCP and page 3-28 of SJCALUCP as follows:

**A12-05  
cont.**

*“Proponents of a project involving objects that may exceed a CFR Part 77 surface must notify the Federal Aviation Administration as required by CFR Part 77, Subpart B, and by the PUC, Sections 21658 and 21659. (Notification to the Federal Aviation Administration under CFR Part 77, Sub-part B, is required even for certain proposed construction that does not exceed the height limits allowed by Subpart C of the regulations. Refer to Appendix D for the specific FAA notification requirements.)*

- *Local jurisdictions shall inform project proponents of the requirements for notification to the FAA*
- *The requirement for notification to the FAA shall not necessarily trigger an airport compatibility review of an individual project by the ALUC if the project is otherwise in conformance with the compatibility criteria established herein.*
- *FAA review is required for any proposed structure more than 200 feet above the surface level of its site. All such proposals shall also be submitted to the ALUC for review regardless of where in the county they would be located.*
- *Any project submitted to the ALUC for airport land use compatibility review for which FAA notification is required shall include a copy of the CFR Part 77 notification to the Federal Aviation Administration and the FAA findings if available.*

*In addition, FAA notification is required for owners or operators proposing to site new, or expand existing, Municipal Solid Waste Landfills (MSWLFs) within a five-mile radius of any airport runway (CFR 40, Subchapter 1, Part 258, Subpart B, Section 258.10). FAA Form 7460-1, Notice of Proposed Construction or Alteration, or other suitable document similar to FAA Form 7460-1 may be used to notify the appropriate FAA Regional Airports Division Office of a planned siting or expansion of a MSWLF, as well as other potential wildlife attractants.”*

**A12-05  
cont.**

### **Transportation Demand Management (aka Dibs Program) Review**

As noted on Page 4-11 of the Draft General Plan, “Policy TR-3.2: Require new development and transportation projects to reduce travel demand, support electric vehicle charging, and accommodate multi-passenger autonomous vehicle travel as much as feasible.

- *Action TR-3.2A - Amend the parking requirements in the Development Code to encourage shared parking, require preferential parking for rideshare vehicles, and allow reduced parking requirements to support transit, bicycling, and walking. (TC-2.21)*
- *Action TR-3.2B - Require commercial, retail, office, industrial, and multifamily residential development to provide charging stations and prioritized parking for electric and alternative fuel vehicles. (NCR-8.9)*
- *Action TR-3.2C - Respond to the implications and opportunities associated with connected vehicles and autonomous vehicles by monitoring technological advances and adjusting roadway infrastructure and parking standards to accommodate autonomous vehicle technology and parking needs.*

SJCOG recommends revising the Draft General Plan to include the following actions:

- Require adding park and ride lots for large developments located near areas of priority as listed in the San Joaquin County Regional Park and Ride Lot Master Plan and future updates. These facilities were envisioned in the 2035 General Plan and many are required as conditions of approval for development projects that have been approved by the City. These park and ride lots need to provide easy access to freeways and be available to carpools, vanpools, and commuter buses.
- Commercial, retail, office, industrial and multifamily residential development should be required to prepare a Transportation Demand Management Plan, to support the Active and Mobile Community Goals, that may include on-site amenities, bike parking, shower facilities, lockers, preferential parking, transportation information kiosks, EV charging stations and park and ride spaces as much as feasible.
- Mitigate potential air quality impacts by requiring large employers and business parks based on employment size to submit a Transportation Demand Management Plan.

As noted on Pages 5-24 and 5-25 of the Draft General Plan, “Policy SAF-4.2: *Encourage major employers to participate in a transportation demand management program (TDM) that reduces vehicle trips through approaches such as carpooling, vanpooling, shuttles, car-sharing, bikesharing, end-of-trip facilities like showers and bicycle parking, subscription bus service, transit subsidies, preferential parking, and telecommuting*

- *Action SAF-4.2A - Provide information and conduct marketing and outreach to major existing and new employers about the transportation demand management (TDM) program facilitated by the San Joaquin Council of Governments.*

**A12-05  
cont.**

SJCOG recommends modifying the Policy SAF-4.2 language as follows:

- Require all new large employers to work with the San Joaquin Council of Governments dibs program to implement a transportation demand management plan to address elements such as California’s Parking Cash-Out Program, vanpooling/carpooling, transit, Emergency Ride Home Program, Preferential Parking, telecommuting, bicycle parking and on-site amenities, and rideshare and transit incentives.

SJCOG recommends adding the following new policy.

- Support San Joaquin Valley Air Pollution Control District Rule 9410 by requiring employers of 100 or more employees to work with the San Joaquin Council of Government’s dibs program to develop and implement a Trip Reduction Program (eTrip).

### RTPA/MPO's Review

As noted on page 3-6 of the Draft General Plan, "*POLICY LU-2.2: Facilitate the development of at least 4,400 new housing units in the Greater Downtown by 2040.*

- *Action LU-2.2A - Amend the Development Code to provide more flexibility for residential development to be feasible, including through a streamlined residential development permit process, and to contribute to the "charm" of the Downtown.* (DV-2.3)
- *Action LU-2.2B - Establish Transit Oriented Development (TOD) Overlay Zones around the Robert J. Cabral ACE Train Station and the San Joaquin Street Amtrak Station to promote high-density residential, including affordable and mixed-income housing, and other TOD.* (DV-2.2)"

Senate Bill 375 (SB 375) provides for some CEQA streamlining relating to growth inducing impacts and impacts from certain vehicle trips for development projects meeting detailed criteria. SJCOG encourages the City to work with SJCOG on the self-certification process for consistency with the RTP/SCS to facilitate streamlining provisions on applicable "transit priority projects."

The 2018 Regional Transportation Plan and Sustainable Communities Strategy (2018 RTP/SCS) recognizes "high-quality" transit as defined by SB 375 to include not only the transit hubs listed (rail stations), but also certain bus transfer stations with two or more major bus routes with a frequency of service interval of 15 minutes or less during peak commute periods and transit corridors meeting the 15-minute interval criteria. SJCOG encourages the addition of these facilities to Action LU-2.2B.

**A12-05  
cont.**

As noted on page 3-6 of the Draft General Plan, "*Action LU-2.2C - Evaluate and implement adjustments to the Public Facilities Fee structure to promote development in the Downtown.* (DV-2.4)"

SJCOG encourages use of the fee discount offered through the Regional Transportation Impact Fee (RTIF) program for development projects meeting specific criteria for "infill projects" and as outlined in the currently adopted program operating agreement to help the City implement this policy action.

As noted on page 4-5 of the Draft General Plan, "*POLICY TR-1.1: Ensure that roadways safely and efficiently accommodate all modes and users, including private, commercial, and transit vehicles, as well as bicycles and pedestrians and vehicles for disabled travelers.* (TC-1.2, TC-1.3)

- *Action TR-1.3A - Protect the Airport and related aviation facilities from encroachment by ensuring that all future development within the Airport Influence Area (AIA) is consistent with the policies adopted by the San Joaquin County Airport Land Use Commission (ALUC), except in cases where the City Council concludes that project approval would provide for the orderly development of the Airport and the areas surrounding it while protecting the public health, safety, and welfare by minimizing the public's exposure to excessive noise and safety hazards.* (LU-6.1, LU-6.2, HS-2.8)"

SJCOG suggests inclusion of language referring to Section 3.1.8 in the currently adopted Airport Land Use Compatibility Plan (ALUCP) for Stockton Metropolitan Airport describing ALUC policies for overruling plan consistency determinations by the ALUC.

As noted on page 5-19 of the Draft General Plan, "*POLICY SAF-2.5 Protect the community from health hazards and annoyance associated with excessive noise levels.* (HS-2)

- *Action SAF-2.5A Prohibit new commercial, industrial, or other noise-generating land uses adjacent to existing sensitive noise receptors such as residential uses, schools, health care facilities, libraries, and churches if noise levels are expected to exceed 70 dBA Community Noise Equivalent (CNEL) (decibels on A-weighted scale CNEL) when measured at the property line of the noise sensitive land use. (HS-2.1)*
- *Action SAF-2.5B Require projects that would locate noise sensitive land uses where the projected ambient noise level is greater than the "normally acceptable" noise level indicated on Table 5-1 to provide an acoustical analysis that shall:*
  - *Be the responsibility of the applicant;*
  - *Be prepared by a qualified person experienced in the fields of environmental noise assessment and architectural acoustics;*
  - *Include representative noise level measurements with sufficient sampling periods and locations to adequately describe local conditions;*
  - *Estimate existing and projected (20-year) noise levels in terms of  $L_{dn}$ /CNEL and compare the levels to the adopted noise policies and actions in this General Plan;*
  - *Recommend appropriate mitigation to achieve compatibility with the adopted noise policies and standards;*
  - *Where the noise source in question consists of intermittent single events, address the effects of maximum noise levels in sleeping rooms in terms of possible sleep disturbance;*
  - *Estimate noise exposure after the prescribed mitigation measures have been implemented;*
  - *If the project does not comply with the adopted standards and policies of this General Plan, provide acoustical information for a statement of overriding considerations for the project; and*
  - *Describe a post-project assessment program, which could be used to evaluate the effectiveness of the proposed mitigation measures. (HS-2.2, HS-2.3, HS-2.13)*

SJCOG recommends including a reference to SEL Noise Exposure Contours maps included as Exhibit 3B in the currently adopted Airport Land Use Compatibility Plan (ALUCP) for Stockton Metropolitan Airport.

**A12-05  
cont.**

August 10, 2018  
Mr. David Stagnaro, AICP  
SJCOG Comments on Envision Stockton 2040 General Plan and DEIR  
Page 8 of 8

Thank you again for the opportunity to comment. SJCOG looks forward to reviewing the Final EIR and the Final Envision Stockton 2040 General Plan documents.

Sincerely,



Andrew T. Chesley  
Executive Director  
San Joaquin Council of Governments

ATTACHMENT A – RCMP Roadway Network  
ATTACHMENT B – Exhibit of Project Site Location in relation to ALUC

**COMMENT LETTER # A12 ATTACHMENT A**  
**A12-1**

**Attachment A**  
**RCMP Roadway Network**

## 2018 Regional Congestion Management Program San Joaquin Council of Governments

Figure 2-1: RCMP Roadway Network

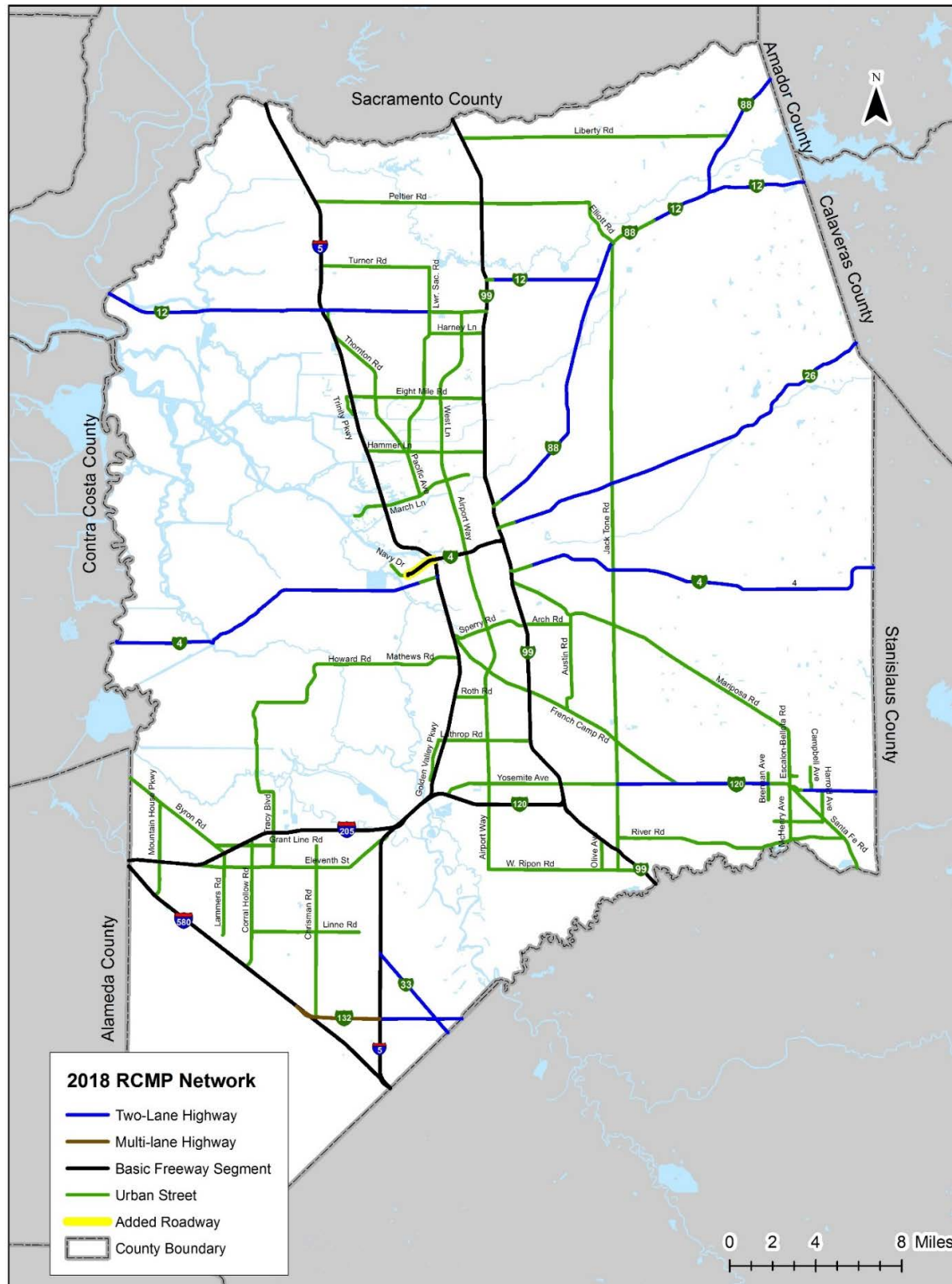



**Attachment B**  
**Exhibit of Project Site Location in relation to ALUC**



# AIRPORT LAND USE CONSISTENCY REVIEW

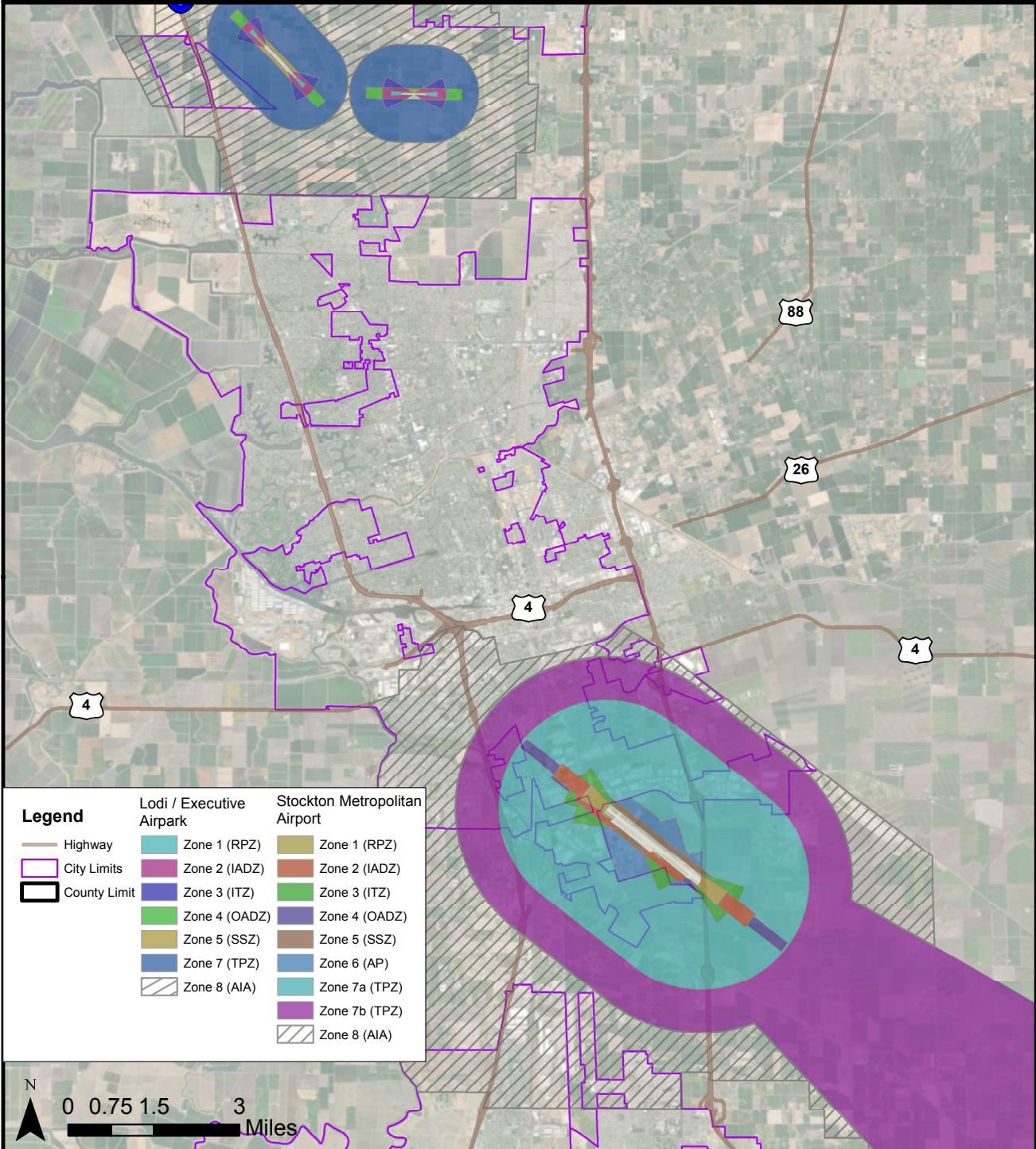

PERMIT NUMBER / PROJECT TITLE: NOA DEIR for Envision Stockton 2040 General Plan  
 ADDRESS: Stockton, CA  
 APN: N/A  
 AIRPORT / "HAZARD TO FLIGHT": All Safety Zones of Stockton Metropolitan Airport and Lodi Airpark.  
 Kingdon Airpark's AIA, TPZ, OADZ, ITZ, IADZ, and RPZ



Via e-mail only

August 10, 2018

David Stagnaro, Planning Manager  
City of Stockton Community Development Dept.  
345 N. El Dorado Street  
Stockton, CA 95202  
[David.Stagnaro@stocktonca.gov](mailto:David.Stagnaro@stocktonca.gov)

Re: Additional Comments on Updated Stockton General Plan and DEIR (Envision Stockton)

David:

The Sierra Club and Campaign for Common Ground submitted previous extensive comments on the draft General Plan document and the Draft EIR in a letter to the Planning Commission dated July 23, 2018. We incorporate by reference all of those previously submitted comments on the adequacy of the DEIR into this second letter and add the following additional comments. We also incorporate by reference the comments in a third letter from the Sierra Club, submitted by members of the local Delta Sierra Group. Please ensure that the Final EIR responds in detail to all of the comments in these three letters from the Sierra Club, as well as the comments received from all other interested parties.

A13-01

**Background on Proposed Growth North of Eight Mile Road**

On July 25, 2017, the City Council considered three options prepared by staff to implement an economic development strategy by reserving land north of Eight Mile Road. During the discussion, City planning staff noted that the amount of land that would be needed for a Tesla factory or a Cal State campus would be in the range of 500 acres. The City Manager forcefully urged the Council to designate the entire Spanos holding of 3,800 acres (not just the 500 acres

A13-02

identified as necessary for economic development) for a huge job-generator to give the City and a potential developer maximum flexibility. There was no discussion about allowing housing north of Eight Mile Road. The City Council agreed to the manager's request.

Fast forward to July 2018 and the city releases the proposed General Plan and the DEIR. The draft plan defines the newly re-named "Economic and Education Enterprise" land use designation that applies to the Spanos lands and suddenly housing has been added into the equation, as follows:

Development in this designation is intended to support the City's economic development goals by attracting new businesses, industries, and/or educational institutions that provide high-quality jobs to the local workforce...Businesses envisioned for this designation include those within a Core Business Cluster industry, as specified in the City's Economic Development Strategic Plan, that provide a significant number of jobs offering wages averaging above Area Median Income, and that cannot be reasonably accommodated elsewhere within the city limit... The designation also allows proximate housing stock that supports the job-generator, including single-family, multi-family, and/or mixed-use dwellings at various levels of affordability, with housing costs that generally correspond to the income levels of the jobs generated by the project...

(emphasis added) (page 2-14 of the draft General Plan)

The amount of housing that is forecast for the Economic and Education Enterprise zone is quite substantial: 26,710 housing units. This amount of housing planned for the land north of Eight Mile Road (or the potential for any housing at all) was never discussed previously by the City Council or by this Planning Commission. The concept of building more housing at this scale north of Eight Mile Road was certainly never discussed at the public meetings we attended.

### **The DEIR Fails to Analyze Impacts Related to Buildout of 3,800 Acres of Ag Land Designated for "Economic and Education Enterprise"**

The fatal flaw of the DEIR comes in its failure to analyze the environmental impacts of any development of the 3,800 acres north of Eight Mile Road, as well as other development. The DEIR justifies this failure by offering a false distinction between "spatial" and "quantitative" inputs of data. The DEIR notes "analyses that require a quantitative estimate of growth include traffic generation, air pollution emissions, greenhouse gas emissions, noise generation, population growth, and impacts on public services and utilities and recreation... For these analyses, the horizon-year projection (i.e., the projected amount of development that could occur under the proposed General Plan through its horizon year of 2040) was considered "reasonably foreseeable" and was used in the analysis" (page 3-28).

However, as we will see in the Table 3-3 from the DEIR (attached) and described below, the DEIR's horizon-year projection assumes that there will be NO development of any kind within

**A13-02  
cont.**

**A13-03**

the 3,800 acres between now and 2040, so impacts related to these “quantitative” topics are ignored in the DEIR, in violation of CEQA.

In contrast, “analyses that are based on spatial location only include aesthetics, agriculture, exposure to localized air pollution and noise, biological resources, cultural resources, geology, hazards and safety, hydrology and water quality, and land use. For these analyses, the question is not *how much* development the General Plan would allow, but *where* that development could potentially be located. Therefore, all potential development allowed by the land use map of the proposed General Plan was evaluated to assess impacts in these topics (i.e., full buildout of the proposed General Plan)” (page 3-28).

So, the DEIR includes some perfunctory analysis of the “spatial” topics related to development of the 3,800 acres, but the discussion is only limited to these topics.

Table 3-3 in the DEIR (attached) is the key to understanding which development areas in the City plan have been analyzed for the full range of CEQA impacts and which areas have been ignored because projected growth is presumed to not occur until after the year 2040. The table lists the development assumptions for Study Area #1 (Eight Mile Road) in the first row. (The Study Area is defined as the area north of Eight Mile Road, as well as the “Bear Creek” projects area south of Eight Mile Road.)

The table indicates that the total amount of growth projected to occur under the horizon-year projection by 2040 in the Eight Mile Road Study Area is 1,380 single family homes, 1,200 multi-family units, and 39,000 square feet of commercial space. According to staff and the DEIR consultant, this amount of growth is assumed to be located in the Bear Creek area south of Eight Mile Road, and that no growth by 2040 would occur on the 3,800 acres of Spanos lands north of Eight Mile Road.

However, for the “full buildout” of the plan beyond year 2040, development on the Spanos lands would include 2,560 single family homes (3,940 minus the Bear Creek homes), a whopping 24,150 multi-family units, 158,000 square feet of commercial space, and over 74 million square feet of “industrial” space (which presumably includes institutional or educational uses).

Notably, assuming 3.23 people per household, the assumption that 26,710 housing units would be constructed north of Eight Mile Road under the full buildout of the plan is equivalent to adding over 86,000 new residents to the city! This DEIR fails to analyze any of the environmental impacts of this amount of new housing growth related to traffic generation, air and greenhouse gas emissions, noise, population growth, and impacts on public services and utilities and recreation.

**A13-03  
cont.**

**The DEIR's Use of Two Development Scenarios in the Project Description and Impact Analysis Is Misleading and Unlawful.**

The DEIR purports to analyze the impacts of the General Plan under two scenarios: "Full Buildout" that assumes development will occur as permitted by the General Plan, and a "Horizon-Year Projection" that assumes that development will occur at significantly less intensity than allowed under the General Plan. DEIR at 3-20 and 3-21. This dual scenario approach is unlawful and is misleading because it underestimates the impacts of the General Plan as proposed.

A13-04

The DEIR assumes the amount of housing growth by 2040 to be 41,400 units, which is only one third of the total amount of housing allowed by the General Plan land use map (120,180 units). For non-residential growth, the discrepancy is even larger: only 17% of the total 293,311,000 square feet of commercial and industrial projected at full buildout is assumed by 2040. Thus, based on the housing projections alone, the traffic, air quality, public services and other environmental impacts of the buildout of the plan are potentially underestimated by two-thirds.

The Project Description is likewise inaccurate and mischaracterizes the amount and location of growth that is allowed by the Plan. The DEIR states that "The proposed General Plan represents a substantial change in the policy framework for future development in Stockton compared to the existing 2007 General Plan. At a macro scale, the fundamental change is from one that concentrates growth in "outfill" areas located at the periphery of the city to one that emphasizes new construction and redevelopment in existing "infill" neighborhoods." DEIR at 3-17.

A13-05

Characterizing this proposed Plan as an "infill-oriented" land use map is not accurate. The text and Tables 3-2, 3-3, and 3-4 clearly identify where the amount of "new" growth allowed by the updated Plan is "emphasized." Less than one-third (31%) of the new growth, excluding the development projects that were already approved under the previous Plan, is in the downtown or the existing neighborhoods (true "infill" growth).

The amount of housing growth assumed by 2040 is 40,900 units, Of that growth, 16,400 units are located in approved, but not yet constructed, development projects within and at the periphery of the existing city limits (including Westlake Villages, Delta Cove, Sanctuary, etc.), while 11,800 units are located in approved/pending projects outside the city limits (Mariposa Lakes and Tra Vigne). The only pending or approved project located in the Greater Downtown Stockton area is the Open Window project (1,400 units).

A13-06

Table 3-3 identifies a total of 13,070 housing units anticipated to be built by 2040 within one of the Plan's "study areas" within the existing city limits, including 4,220 multiple family units in the "Miner/Weber" and "El Dorado/Center Corridors," and at the "Port /Waterfront." Table 3-2 identifies 12,100 units as "growth from the proposed General Plan" excluding approved and pending projects (it is unclear why there is a seeming discrepancy between these two tables).

A13-07

So, out of the 40,900 housing units projected under the Plan by 2040, about 14% (5,620 units) of the growth may occur in the downtown, 17% (7,880 units) is assumed as infill growth in the existing neighborhoods outside of the downtown, 40% (16,400 units) consists of already approved projects at the periphery of the city limits, and the remaining 29% (11,800 units) is assumed in the projects outside the city limits.

A13-08

The additional housing growth that is allowed by the Plan, but which is not assumed by 2040, amounts to 78,800 housing units (including 26,000 units north of Eight Mile Road), with more than three-quarters of that growth occurring outside of the downtown and existing neighborhoods.

The Project Description and the DEIR must be re-written and recirculated to rectify this gross deficiency. The City may wish to retain an analysis of impacts for the “horizon year” of 2040, however, the City is absolutely required under the provisions of the California Environmental Quality Act (“CEQA”) and forty years of case law to also divulge all the specific impacts, at the same level of detail as the 2040 impacts, for the full buildout of the Plan.

A13-09

In a 2005 case with facts analogous to the present situation, the Placer County Superior Court held that the agency must analyze the full amount of development being approved under a community plan (*Sierra Watch et al. v. Placer County et al.* (Placer County Superior Court No. SCV 16652)). Like the DEIR here, Placer County’s EIR assumed that full build-out of the plan would be unrealistic. The EIR reduced the level of development in the project description to a more “realistic” level that was likely to occur in the plan area. The judge found the project description to be inadequate and held, “The time to study the likely affects of specific and cumulative impacts is at the time that the potential for development is known, whether or not that development actually occurs” (citing *Christward Ministry v. Superior Court* (1986) 184 Cal.App.3d 180, 194; and *Bozung*).

A13-10

The City has no mechanism in place to limit the amount of growth during the 22-year life of the Plan. Therefore, build-out could be reached in the next 22 years. See *San Joaquin Raptor/Wildlife Rescue Center v. County of Merced* (2007), 149 Cal.App.4th at 655-56. For this reason, the EIR should have evaluated what is actually allowed under full buildout in the Plan Area over the life of the Plan. Had the DEIR properly evaluated the impacts of full development under the Plan, it would have identified additional significant impacts resulting from tens of thousands of new residential units and jobs.

A13-11

In summary, the Project that must be described and analyzed in the DEIR is the Full Buildout and not the Horizon-year Projection. The importance of this distinction is not merely theoretical. The Full Buildout allows for thousands of additional dwelling units and retail space and approximately nine times as much new commercial space and industrial space, as is assumed

A13-12

under the Horizon-Year Projection. Because the DEIR improperly fails to assume development as allowed under the General Plan, it significantly underestimates the Project's impacts.

Accordingly, the DEIR is fundamentally misleading to the public and decisionmakers, in violation of CEQA. "[O]nly through an accurate view of the project may the public and interested parties and public agencies balance the proposed project's benefits against its environmental cost, consider appropriate mitigation measures, assess the advantages of terminating the proposal and properly weigh other alternatives." *City of Santee v. County of San Diego*, 214 Cal. App. 3d 1438, 1454 (1989). Thus, because the DEIR fails to describe the Project properly, it fails to serve its purpose as an informational document. See *San Joaquin Raptor Rescue*, 149 Cal. App. 3d at 674.

A13-12  
cont.

**CEQA Requires that the DEIR Analyze the Potential Impacts of the Development as Permitted Under the General Plan.**

Courts have consistently held that an EIR must examine a project's *potential* to impact the environment, even if the development may not ultimately materialize. *Bozung v. Local Agency Formation Comm'n*, 13 Cal. 3d 263, 279, 282 (1975). Because general plans serve as the crucial "first step" toward approving future development projects, a general plan EIR must evaluate the amount of development actually allowed by the plan. *City of Carmel-By-the-Sea v. Bd. of Supervisors of Monterey County*, 183 Cal. App. 3d 229, 244 (1986); *City of Redlands v. County of San Bernardino*, 96 Cal. App. 4th 398, 409 (2002). Thus, an agency may not avoid analysis of such development merely because historic and/or projected land use trends indicate that the development might not occur.

A13-13

In *San Joaquin Raptor Rescue Center v. County of Merced*, 149 Cal. App. 4th 645 (2007), the Court of Appeal confirmed an agency's obligation to describe and analyze the impacts from the whole project, and "not some smaller portion of it." *Id.* at 654. The project at issue in *San Joaquin Raptor* was a new Conditional Use Permit ("CUP") for an existing aggregate mine and processing operation. The new CUP authorized a maximum production level of 550,000 tons per year, which was an increase over existing levels. However, historic mine production rates indicated that actual production could be less than the theoretical maximum. Based on historic rates and projected future rates, the EIR "estimated average production of about 260,000 tons per year." *Id.* at 655. The court held that the EIR's identification of the estimated average in the project description, rather than the maximum level of production authorized by the CUP, violated CEQA. The court stated: "By giving such conflicting signals to decisionmakers and the public about the nature and scope of the activity being proposed, the Project description was fundamentally inadequate and misleading." *Id.* at 655-56.

A13-14

The Court of Appeal in *Stanislaus Natural Heritage Project v. County of Stanislaus*, 48 Cal. App. 4th 182 (1996), reached a similar conclusion in a slightly different context. The county argued that an EIR can avoid providing a full analysis of water supply for future phases of a proposed development project because the EIR included a mitigation measure that would prevent

A13-15



development of those future phases until a water supply had been identified. The court rejected this argument and held that a lead agency must assume that a project will be developed as *planned* and must evaluate the impacts of the *planned* project, not a potential, more limited project. *Id.* at 205-06.

A13-15  
cont.

This DEIR attempts to justify its failure to describe and analyze the entirety of the General Plan by stating that it need only evaluate “the ‘reasonably foreseeable’ direct and indirect impacts of the proposed project.” DEIR at 3-20. The City has taken the “reasonably foreseeable” language from the definition of project under the CEQA Guidelines, but has misinterpreted its meaning. Under CEQA, a project means “*the whole of an action*, which has a potential for resulting in either a direct physical change in the environment, or a reasonably foreseeable indirect physical change in the environment . . . .” CEQA Guidelines § 15378(a). “Reasonably foreseeable” describes the likelihood of indirect impacts; it does not suggest that an EIR need only evaluate the “reasonably foreseeable” aspects of a project. Rather, it makes clear that a project is a “whole of an action.” Here, the whole of the action is the level of development permitted under the General Plan. If the City would like to limit its analysis to a predicted amount of growth, it must also limit the allowable development to that lower level by placing those restrictions in the General Plan itself.

A13-16

#### **“Piecemealing” a Project Is Not Allowed Under CEQA**

City staff and the consultant have justified the DEIR’s failure to analyze traffic and other impacts for projects assumed not to occur by 2040 (including the 3,800 acres north of Eight Mile Road) by promising that full environmental analysis and mitigation of impacts will be prepared if and when applications are submitted sometime in the future. This approach segments the project and results in the deferral of environmental analysis.

As described by the Association of Environmental Professionals, piecemealing or segmenting means dividing a project into two or more pieces and evaluating each piece in a separate environmental document, rather than evaluating the whole of the project in one environmental document. This is explicitly forbidden by CEQA, because dividing a project into a number of pieces would allow a Lead Agency to minimize the apparent environmental impacts of a project by evaluating individual pieces separately, each of which may have a less-than- significant impact on the environment, but which together may result in a significant impact. Segmenting a project may also hinder developing comprehensive mitigation strategies.<sup>1</sup>

A13-17

---

<sup>1</sup> Association of Environmental Professionals, CEQA Portal Topic Paper posted at: <https://ceqaportal.org/tp/Project%20Description%2003-23-161.pdf>.

CEQA prohibits such segmentation of a project. See *Tuolumne County Citizens for Responsible Growth, Inc. v. City of Sonora* (2007) 155 Cal.App.4th 1214, 1229 (“when one activity is an integral part of another activity, the combined activities are within the scope of the same CEQA project” and must be analyzed together); Guidelines § 15378(a) (“‘Project’ means the whole of an action, which has a potential for resulting in either a direct physical change in the environment, or a reasonably foreseeable indirect physical change in the environment.”). Breaking the project into smaller sub-projects will lead to inadequate environmental review. See, e.g., *Bozung v. Local Agency Formation Commission* (1975) 13 Cal.3d 263, 283-84 (CEQA mandates that “environmental considerations do not become submerged by chopping a large project into many little ones”).

A13-17  
cont.

This DEIR analysis has arbitrarily divided the buildout of the General Plan into two separate projects: the development that is assumed to occur by 2040, and the remaining development that is expected after that date. The DEIR must analyze the impacts of the *full* level of residential, commercial, and industrial uses approved by the General Plan. The maximum level of development approved by the General Plan is the project being approved, not a “reasonably foreseeable” year 2040 scenario. Defining and analyzing “the whole of the project” being approved is a long-standing requirement under CEQA. The courts have consistently held that an EIR must examine a project’s potential to impact the environment, even if the development may not ultimately materialize. *Bozung v. Local Agency Formation Com.* (1975) 13 Cal.3d 263, 279, 282.

A13-18

**The DEIR’s Failure to Analyze Full-Build Out Under the Proposed Plan Implicates the Entire Document.**

As discussed above, the DEIR assumes that only partial build-out of the development allowed under the proposed General Plan will take place by 2040. This assumption is carried out throughout the DEIR, which implicates analyses throughout the document. For example, the DEIR’s use of the Horizon-Year Projection results in a skewed traffic impact analysis because the analysis fails to include impacts from traffic associated with allowed Economic and Education Enterprise uses north of Eight Mile Road. The DEIR’s evaluation of impacts to water supply is similarly incomplete. These failures are carried forth into the alternatives analysis as well. The alternatives analysis failure to account for full build-out results in an analysis that compares impacts from the alternatives to only *some* of the impacts that will take place under full build-out. For example, the alternatives analysis concludes that the proposed Plan and the Infill Alternative would have similar impacts associated with growth in population and housing. DEIR at 5-26. This conclusion is incorrect because the DEIR fails to take into account the thousands of additional housing units and millions of additional square feet of commercial, industrial, and institutional uses allowed under the Plan.

A13-19

A13-20

A13-21

**The DEIR Fails to Propose Feasible Mitigation Measures to Reduce the Plan’s Significant Impacts.**

An EIR is inadequate if it fails to suggest feasible mitigation measures, or if its suggested mitigation measures are so undefined that it is impossible to evaluate their effectiveness. *San Franciscans for Reasonable Growth v. City and County of San Francisco* (1984) 151 Cal.App.3d 61, 79. Of course, the City may not use the inadequacy of its impacts review to avoid mitigation: “The agency should not be allowed to hide behind its own failure to collect data.” *Sundstrom v. County of Mendocino* (1988) 202 Cal.App.3d 296, 36. The proposed General Plan update would allow development of more than 120,000 residential units (under full buildout) and more than 300 million square feet of commercial, office, and industrial uses; CEQA mandates that these impacts be fully evaluated and minimized. *Id.*

A13-22

**The DEIR Fails to Provide Adequate Mitigation for Significant Impacts Related to Loss of Agricultural Land.**

The California Legislature has repeatedly asserted that preservation and protection of state farmland is an important policy goal and that CEQA is an important tool that should be used to carry out this goal. *Masonite Corp. v. Cnty. of Mendocino*, 218 Cal. App. 4th 230, 240 -241 (2013) (“our Legislature has repeatedly stated the preservation of agricultural land is an important public policy”). In particular, “[a]gricultural lands near urban areas that are maintained in productive agricultural use [such as the ones near Stockton] are a significant part of California’s agricultural heritage.... Conserving these lands is necessary due to increasing development pressures and the effects of urbanization on farmland close to cities.” Pub. Resources Code, § 10201(c). “The Legislature has also declared that CEQA is intended to effectuate this public policy.” *Masonite Corp.*, 218 Cal. App. 4th at 241.

Here, the DEIR acknowledges that the proposed General Plan would designate more than 16,000 acres of farmlands of concern under CEQA for non-agricultural uses and would designate more than 2,400 acres of lands with active Williamson Act contracts for non-agricultural uses. DEIR at 2-7, 4.2-10, and 4.2-13. The DEIR weakly concludes in Impact AG-1:

A13-23

“Although the proposed General Plan includes policies and actions that would reduce and partially offset the conversion of farmland, it designates approximately 16,160 acres of farmlands of concern under CEQA for non-agricultural uses. Because these farmland areas are located near existing urbanized areas, they may not be viable for agricultural operations due to conflicts with nearby urbanized areas. The only way to mitigate this impact would be to prohibit any development on farmland of concern. CEQA does not require that the project be changed in order to avoid an impact, and no additional mitigation is available, resulting in a significant and unavoidable impact.”

The DEIR includes no mitigation measures whatsoever to offset these losses of agricultural land. *Id.* Instead, the DEIR relies on proposed General Plan policies requiring 1:1 mitigation for loss of agricultural lands through conservation easements or fees to offset this impact. DEIR at 4.2-12.

This General Plan policy is insufficient to reduce impacts from loss of agricultural land of this magnitude. It is well understood that requiring agricultural conservation at a 1:1 ratio does not “fully mitigate farmland conversion, since a 1:1 ratio is only adequate to protect half of the existing farmland base in [the] county.” *Building Industry Assn. v. County of Stanislaus* (2010) 190 Cal.App.4th 582, 591-92. In other words, if the County loses one acre of farmland but then mitigates that loss by preserving a second acre of existing farmland, it has still lost 50 percent of the original farming acreage—it started with two acres and now has only one. Because General Plan Action LU-5.3.C will thus not fully offset the loss of farmland caused by the Project, the DEIR correctly concludes that the Project’s farmland impacts remain significant. See *Citizens for Open Government v. City of Lodi* (2012) 205 Cal.App.4th 296, 322 (finding conversion of 40 acres of farmland a significant impact even after purchase of conservation easements at a 1:1 ratio). However, the DEIR stops short of requiring additional mitigation to reduce impacts further. A revised EIR must identifying additional mitigation to address this impact.

**A13-23  
cont.**

In addition, although the proposed General Plan states that “local agricultural lands provide needed buffers between Stockton and neighboring cities” (Envision Stockton 2040 General Plan at 3-20), neither the Plan nor the DEIR adequately address the need for an agricultural buffer between Stockton and surrounding cities. The draft General Plan includes Action LU-5.3B, which provides that the City will “[C]oordinate with San Joaquin County to develop a plan for a greenbelt or community separator around the city.” However, the proposed General Plan provides no details as to what such a greenbelt plan would entail or how it would be implemented.

**A13-24**

Given the importance of agricultural lands, and the proposed Plan’s significant impacts on a substantial amount of farmland, the DEIR should have included a more robust analysis that included specific mitigations. Instead, the DEIR concludes that impacts to agricultural lands would be significant but fails to identify *any* additional policies or implementation actions describing concrete regulations and/or incentives to preserve agricultural land buffers.

**A13-25**

A mitigation measure should be added that requires the City, in concert with the County, the City of Lodi, the Central Valley Farmland Trust, residents and affected landowners, to prepare an Agricultural Buffer Action Plan that addresses, among other items, how to target the fees that are collected by the two cities and the County toward purchasing easements within the defined buffer area. The general location of the Agricultural Buffer Area should also be identified on the Plan Land Use Diagram map.

**A13-26**

As have noted elsewhere, we remind the City and consultant that CEQA requires that all feasible measures be identified that would reduce impacts, even if the final result would be “significant and unavoidable.”

A13-27

**The DEIR Fails to Evaluate Potential Impacts and Propose Feasible Mitigation Measures to Reduce the Plan’s Significant Impacts Related to Transportation.**

A layperson reading the DEIR who was concerned about the potential traffic impacts related major growth planned north of Eight Mile Road might logically ask “Would a new interchange on I-5 be required to serve that growth?” However, there is no discussion or analysis, much less mitigation required for this planned growth. The section notes that “Because the proposed General Plan scales back land use development assumptions through 2040, some of the roadway network improvements to support previously planned development, such as development north of Eight Mile Road, were not included in the proposed General Plan network”. DEIR at 4.14-26.

A13-28

Similarly, there is no discussion of transportation impacts related to the construction of the largest of the “approved” projects such as Mariposa Lakes, which would directly contribute to gridlock conditions on State Route 99, and the Sanctuary/Westlake Villages/Delta Coves projects, which will affect I-5. The transportation analysis in the DEIR is remiss in failing to summarize the mitigation requirements that were included in the certified EIRs, development agreement, and/or conditions of approval for these projects.

A13-29

We are disappointed that the entire analysis fails to offer any mitigation measures to address funding of new transportation improvements that are needed to serve the growth, or how projects will contribute their fair share of the cost.

A13-30

The mitigation measures that are recommended are inadequate and in some cases fail to address the impacts that have been identified. For example, Impact TRAF-1 states “Implementation of the proposed General Plan, in combination with regional growth, would result in increased vehicle traffic, which would affect the operation of local roadways and freeway segments. As shown in Table 4.14-2 and discussed above, the proposed General Plan would result in significant level-of-service impacts to roadway and freeway segments.”

Mitigation Measure TRAF-1a requires the City to conduct focused complete streets or engineering studies but fails to explain how the required improvements would be funded. The DEIR concludes that the impacts on local streets would be “Significant and unavoidable. While implementation of Mitigation Measure TRAF-1a would retain right-of-way to provide wider cross-sections than are envisioned under the proposed General Plan subsequent to detailed evaluation, parallel capacity and/or additional right-of-way is not available to mitigate some impacts, and the City cannot guarantee that funding would be available to conduct additional evaluations and construct identified improvements.” This constitutes a gross failure to protect

A13-31

the existing and future residents from unacceptable traffic congestion resulting from new growth. The City has an existing traffic mitigation fee program. Will there be enough money collected in the future to pay for these improvements or not?

**A13-31  
cont.**

Likewise, Mitigation Measure TRAF -1b states the following: “The City shall implement the following to reduce the severity of potential LOS impacts on the following freeway segment: State Route 99 between Farmington Road and Fremont Street. The Cumulative with Proposed Plan transportation analysis considers the widening of State Route 99 through Stockton to its ultimate planned width. No additional improvements have been identified. Implementation of the proposed General Plan and its associated policies are expected to provide alternative travel choices to Stockton residents and workers, shifting travel patterns and modes. However, deficient operations are expected to occur on State Route 99, and this impact would remain significant and unavoidable. Significance With Mitigation: Significant and unavoidable.”

**A13-32**

The DEIR analysis fails to consider how required contributions from major development in the area (Mariposa Lakes and industrial projects near the airport) could fund roadway improvements, including transit, ridesharing and other programs to reduce the impacts of a gridlocked freeway segment. CEQA requires that all feasible measures be identified that would reduce impacts, even if the final result would be “significant and unavoidable.” A revised DEIR should include an analysis of potential programs that could address the freeway congestion and reduce trips.

As noted below under the “Settlement Agreement” discussion, we strongly disagree with the conclusion in Impact TRAF-6 that “Implementation of the proposed Plan would not conflict with adopted policies, plans, or programs regarding public transit, bicycle, or pedestrian facilities, or otherwise decrease the performance or safety of such facilities.” DEIR at 4.14-26. The Plan policies and actions that are cited as addressing these issues are vague and unimplementable. Action TR-2.3.B states “Obtain input from local and regional transit operators on major new development projects to ensure new projects are designed to support transit and provide adequate transit service and access.” “Obtaining input” is vague and normally occurs as part of the review process. The Actions and the Policy TR-2.2 must be re-written to specifically require that major new projects may not be approved unless the plans include facilities and a funding mechanism to pay for transit connections and address shortfalls in transit operating funds that have been identified in the Transit Gap Analysis, to ensure the new project pays the full cost for the transit connection needed.

**A13-33**

We are incredulous that there is no discussion and analysis of the Transit Gap Analysis in the entire transportation section (Transit Gap Study, January 2010). It is as if the City and consultant want to ignore the study, which was required as part of the Settlement Agreement. Please include such a discussion and analyze whether the Plan impacts rectify or worsen the “gaps” identified in the study.

**A13-34**

Finally, the San Joaquin Council of Governments Regional Transportation Plan/Sustainable Communities Strategy (RTP/SCS) update was adopted on June 28, 2018. The current DEIR analysis of the consistency of the Plan was based on the 2014 RTP/SCS. The DEIR must be revised so that the analysis is based on the most recent RTP/SCS.

A13-35

**The DEIR Fails to Adequately Analyze and Mitigate for the General Plan’s Greenhouse Gas Emissions.**

The DEIR concludes that the Project’s impacts from GHG emissions are significant because the Project conflicts with the goal of Executive Order S-03-05 to reduce GHG emissions by 80% below 1990 levels by 2050. DEIR at 4.7-27. Yet the DEIR fails to actually disclose the extent of the impact, as required by CEQA.

An agency’s rote acknowledgement that impacts are “significant” does not cure an EIR’s failure to analyze the issue. As the court stated in *Galante Vineyards v. Monterey Peninsula Water Management Dist.*, 60 Cal. App. 4th 1109 (1997), “this acknowledgment is inadequate. ‘An EIR should be prepared with a sufficient degree of analysis to provide decisionmakers with information which enables them to make a decision which intelligently takes account of environmental consequences . . . .’” *Id.* at 1123 (quoting *Santiago County Water Dist. v. County of Orange*, 118 Cal. App. 3d 818, 831 (1981)); see also *Mira Monte Homeowners Assn. v. County of Ventura*, 165 Cal. App. 3d 357, 365 (1985) (an EIR is meant to protect “the right of the public to be informed in such a way that it can intelligently weigh the environmental consequences of a[] contemplated action.”). Thus, an agency may not, as the City attempts to do here, “travel the legally impermissible easy road to CEQA compliance . . . [by] simply labeling the effect ‘significant’ without accompanying analysis . . . .” *Berkeley Keep Jets Over the Bay Committee v. Board of Port Commissioners*, 91 Cal. App. 4th 1344 1371, 2001.

A13-36

This is precisely what the DEIR does in regard to its conclusion that the Project’s noncompliance with Executive Order S-03-05 is a significant impact. DEIR at 4.7-30. The DEIR calculates the GHG emissions in 2040 under the proposed General Plan and concedes that the proposed General Plan would result not only in exceedance of the bright-line threshold of significance for GHG emissions, but it would also fail to achieve Plan-level thresholds of significance for both 2040 and 2050. DEIR at 4.7-28 and 4.7-29 -30. DEIR at 4.7-29. However, it fails to identify the level the GHG emissions need to be in 2040 to be on track to meet the 2050 goal set by the executive order. Thus, the EIR fails to disclose to what extent the GHG emissions under the General Plan will fail to meet the target emissions. Accordingly, under CEQA, “a more detailed analysis of how adverse the impact will be is required.” *Galante Vineyards*, 60 Cal. App. 4th at 1123.

The DEIR further fails to meet the requirements of CEQA because it fails to identify any mitigation measures to lessen the Plan’s significant increase in emissions and its noncompliance with Executive Order S-03-05. Instead, the DEIR concludes that “Mitigation Measure GHG-1 would reduce GHG emissions to the extent feasible” and that no additional

A13-37

mitigation is available. DEIR at 4.7-31. To the contrary, the most effective mitigation measure for most of the General Plan’s impacts, including climate impacts, is to modify the land use diagram and land use designations to discourage sprawl, to increase the density of residential uses, and to increase mixed-use residential and commercial areas that are designed to be walkable and to be near mass transit systems.

A13-37  
cont.

In addition, of the measures the DEIR does include to address GHG impacts, several are vague, incomplete, insubstantial, and nonbinding, and thus cannot be relied on to mitigate Project impacts. For example, Mitigation Measure GHG-1 directing the City to update the City’s Climate Action Plan (“CAP”) specifies that targets and strategies in the CAP would only be required to 2030. DEIR at 4.7-30. This approach is unlawful. Moreover, because the General Plan will be in effect until 2040, the DEIR must analyze the impacts of full-buildout from the plan out to 2040.

A13-38

A13-39

Second, Mitigation Measure GHG-1 includes a list of measures that may be included in the CAP. But once again the DEIR states only that the “City shall *consider*” the measures rendering the measures unenforceable. DEIR at 4.7-30; emphasis added. M-GHG-1 also proposes that the City ‘consider’ establishing goals for 15 percent of existing development to install solar panels over carports and to power five percent residential and 10 percent of non-residential development with solar energy. Id. But the DEIR provides no explanation of why these percentages are appropriate or whether greater reductions are infeasible. DEIR at 4.7-30 and 31. Measures relied upon to mitigate impacts must be “fully enforceable” through permit conditions, agreements, or other legally binding instruments. Pub. Res. Code § 21081.6(b); CEQA Guidelines §15126.4(a)(2). Similarly, the mitigation must provide assurance that it will be implemented, and not merely adopted and then disregarded. *Anderson First Coalition v. City of Anderson* (2005) 130 Cal. App. 4th 1173, 1186-87; *Fed’n of Hillside & Canyon Assn’s v. City of Los Angeles* (2000) 83 Cal. App. 4th 1252, 1261. M-GHG-1 is neither and is insufficient without substantial evidence that further mitigation is infeasible.

A13-40

A13-41

A13-42

In summary, the vague, voluntary, and unenforceable policies cited as mitigation measures in the DEIR fail to comply with CEQA, which requires enforceable, concrete commitments to mitigation. As a result, the DEIR completely fails to describe measures that could avoid or substantially lessen the General Plan’s numerous significant impacts. These inadequacies require that the DEIR be revised and recirculated so that the public and decision-makers are provided with a proper analysis of the proposed General Plan’s significant environmental impacts and feasible mitigation for those impacts. See CEQA Guidelines § 15002(a)(1) (listing as one of the “basic purposes” of CEQA to “[i]nform governmental decision makers and the public about the potential, significant environmental effects of proposed activities”).

A13-43



## **The Draft General Plan Policies are Not Consistent with the Settlement Agreement**

The greenhouse gas section of the DEIR inaccurately describes the consistency of the proposed General Plan with the terms of the Settlement Agreement signed between the City, the Sierra Club, and the State Attorney General's office, and concludes the following:

The proposed General Plan limits the opportunity for new development in the SOI (i.e., outside the city limit) mainly to what has already been approved. While the EIR evaluates growth from existing conditions that includes an increase in emissions from approved and pending projects outside the city limit, the proposed General Plan focuses new growth in Greater Downtown Stockton and the city limit. As identified in the table, overall, the proposed General Plan includes and/or considered the mandatory measures listed in the Settlement Agreement. Additionally, Mitigation Measure GHG-1 ensures that updates to the measures are considered in the update to the CAP. Therefore, the proposed project would not conflict with the mandatory stipulations in the 2008 Settlement Agreement and the impact is considered less than significant. (DEIR at 4.7-32)

This paragraph mischaracterizes the amount and location of growth that is allowed by the Plan. The statement that the Plan "limits the opportunity for new development in the SOI (i.e., outside the city limit) mainly to what has already been approved" is not accurate, since the Plan would allow over 26,000 housing units north of Eight Mile Road, which is within the Sphere but is not an "approved" project."

Likewise, the claim that "the proposed General Plan focuses new growth in Greater Downtown Stockton and the city limit" is not supported by the evidence presented in the Project Description chapter of the DEIR. The text and Tables 3-2, 3-3, and 3-4 clearly identify where the amount of "new" growth allowed by the updated Plan is "focused," and less than one-third (31%) of the new growth, excluding the development projects that were already approved under the previous Plan, is in the downtown or the existing neighborhoods.

Out of the 40,900 housing units projected under the Plan by 2040, about 14% (5,620 units) of the growth may occur in the downtown, 17% (7,880 units) is assumed as infill growth in the existing neighborhoods outside of the downtown, 40% (16,400 units) consists of already approved projects at the periphery of the city limits, and the remaining 29% (11,800 units) is assumed in the projects outside the city limits.

The additional housing growth that is allowed by the Plan, but which is not assumed by 2040, amounts to 78,800 housing units (including 26,000 units north of Eight Mile Road), with more than three-quarters of that growth occurring outside of the downtown and existing neighborhoods.

**A13-44**

Table 4.7-8 notes that “The Agreement requires consideration of the following amendments to the General Plan to ensure that development on the city’s outskirts does not grow in a manner that is out of balance with development of infill. The Agreement does not require actual City Council adoption of such policies or programs. Amendments shall include measures limiting the granting of entitlements for certain development projects outside the city limit until certain criteria are met:

(a) Urban Performance Measures. Minimum levels of transportation efficiency, transit availability, and level of service; City service capacity; water availability; and other urban services performance measures.”

A13-45

The designation of 3,800 acres of agricultural land north of Eight Mile Road for urban development of “Economic and Education Enterprise” land uses as a key component of this updated Plan (which constitutes a very significant amendment to the existing General Plan) is grossly inconsistent with this requirement of the Settlement Agreement. The Plan includes no policies that specify “Minimum levels of transportation efficiency, transit availability, and level of service; City service capacity; water availability; and other urban services performance measures” for this project. In fact, the Plan and this DEIR are virtually silent on the transportation improvements that would be required to serve this growth, as well as whether the City could provide efficient transit service, water supply, and other urban services. The table concludes that Actions LU-6.1.B through LU-6.1.G of the Plan would address these specifications but they do not.

Another example of the inconsistency between the Settlement Agreement and the Plan is the requirement “that housing or development projects subject to a Specific Plan/Master Development Plan or regionally significant projects provide financial and/or other support for transit use. Fees are required to cover the project’s fair share of the transit system and contribute to the overall VMT goals of the CAP and Transit Gap Study.”

As discussed in the comments on traffic impacts above, the Plan policies and actions that are cited as addressing this requirement are vague and unimplementable. The Actions and the Policy TR-2.2 must be re-written to specifically require that major new projects may not be approved unless the plans include facilities and a funding mechanism to pay for transit connections and address shortfalls in transit operating funds that have been identified in the Transit Gap Analysis, to ensure the new project pays the full cost for the transit connection needed.

A13-46

### **The DEIR Fails to Mitigate Significant Noise Impacts**

The DEIR determines that the increase in noise under the “build” alternatives would result in significant impacts along 14 roadway segments. DEIR at 2-21. In this instance, the DEIR fails to propose *any* mitigation measures whatever to reduce impacts.

A13-47

The County has a duty to consider other feasible mitigation. CEQA Guidelines § 15126.4(a). For example, the County could consider the use of rubberized asphalt on county roadways (and committing to working with Caltrans to implement the measure on highways). Rubberized asphalt is a material that has been proven to be quite effective as a noise attenuation measure. Rubberized asphalt can result in an average of a four dBA reduction in traffic noise levels as compared to conventional asphalt. See “Report on the Status of Rubberized Asphalt Traffic Noise Reduction in Sacramento County”, Bollard & Brennan, Inc., November 1999 (attached to this letter). This level of noise attenuation is significant, as it represents a 60 percent reduction in traffic noise energy, and a clearly perceptible decrease in traffic noise. *Id.* Mature landscaping planted just outside the freeway right of way can also be effective noise mitigation. A revised DEIR must consider these and other feasible mitigation measures to reduce Project-related permanent increases in noise levels.

A13-47

**The DEIR Fails to Adequately Analyze and Mitigate for the General Plan’s Lack of Adequate Water Supply.**

As with the other sections of the DEIR, the impact analysis and mitigation measures for groundwater supply, surface water supply, wastewater, and storm drainage systems are legally inadequate because only a portion of the total growth (about one-third of the housing) allowed under the proposed General Plan is considered. This affects the analysis in both the Hydrology and Water Quality, and Utilities and Services Systems chapters of the DEIR.

A13-48

In summary, the analysis and conclusion related to impacts to groundwater supplies contained in both chapters is not supported by the facts. The City’s intent to more than triple groundwater pumping may not be realized and thus reliance on groundwater may be seriously over-estimated. In addition, the water supply analysis for the year 2040 portion of the growth is flawed because the water supply projections for 2040 assume 50,000 acre-feet from the City’s Delta Water Supply Project, which is dependent on a permit approval by the State Water Resources Control Board, which may not occur. Finally, the water supply analysis does not fulfill the requirements of the State Water Code.

A13-49

A13-50

A13-51

In the Hydrology chapter, Impact HYDRO-2.1 states: “Implementation of the proposed project would not substantially deplete groundwater supplies.” This is not an accurate conclusion based on the facts that are presented in the DEIR, as we note below.

The DEIR describes the very serious groundwater situation:

A13-52

“The Eastern San Joaquin Subbasin is identified as a critically overdrafted groundwater basin. Average groundwater use in the Eastern San Joaquin Subbasin is about 809,321 acre-feet per year (afy), of which approximately 95 percent is for agricultural uses and 5 percent for

municipal and industrial uses. Historically, groundwater elevations have declined about 40 to 60 feet, averaging approximately 1.7 feet per year. As a result, a regional cone of depression has formed in eastern San Joaquin County, creating a gradient that allows saline water underlying the Delta region to migrate northeast within the southern portions of the EIR Study Area.

Extensive groundwater pumping has caused movement of the saline waters eastward from under the San Joaquin Delta. Groundwater flow in the Basin now converges on the depression with relatively steep groundwater gradients eastward from the Delta toward the depression east of Stockton. The eastward flow from the Delta area is significant because of the typically poorer quality water now moving eastward in the Stockton area. Degradation of water quality due to saline migration threatens the long-term sustainability of the underlying basin. Salt-laden groundwater is unusable for urban drinking water needs and for irrigating crops.” DEIR at 4.9-13 and 14.

**A13-52  
cont.**

Critically overdrafted groundwater basins, including the Eastern San Joaquin Subbasin, are required to be managed under a Groundwater Sustainability Plan by January 31, 2020. The very perfunctory description of this important new law (the Sustainable Groundwater Management Act) on page 4.9-15 of the DEIR should be augmented to include the detailed requirement of the law and its required plan and implementation.

Groundwater supplies for the City’s two water purveyors (Cal Water and the City) are forecast to increase from about 13,368 acre-feet per year (afy) in 2015 to 29,840 afy in 2040. Cal Water is using only 6,740 afy of groundwater in 2015 and is forecast to rely on that same amount of pumping through 2040. In stark contrast, the City currently pumps about the same amount as Cal Water (6,628 afy) but intends to more than triple that amount by 2020 (23,100 afy) and continue pumping at that rate through 2040 (Table 4.15-1). The analysis in both the Hydrology and the Utilities chapters must provide evidence to support the conclusion that tripling the amount of groundwater pumping to serve new growth would not deplete groundwater supplies.

**A13-53**

The DEIR contains the following statement that is not discussed or includes no technical study citation: “COSMUD pumps groundwater from the East San Joaquin Subbasin of the San Joaquin Valley Groundwater Basin. The City estimates the sustainable groundwater yield to be approximately 50,000 afy.” DEIR 4.15-5. Please provide the scientific basis for this unsupported statement.

**A13-54**

The City’s plans to more than triple groundwater pumping may not be implemented and the DEIR must describe and analyze this possibility. Groundwater supplies to serve growth in north Stockton may not increase if a reduction or curtailment of pumping becomes a management tool to address the Eastern San Joaquin Groundwater Subbasin critically overdrafted state. The

**A13-55**

analysis in the Hydrology and Utilities chapters fails to adequately explain and disclose the ramifications of the pending Groundwater Sustainability Plan, and how overall groundwater supplies may be affected in the future. The DEIR analysis must be augmented with a realistic discussion of how implementation of the Sustainable Groundwater Management Act may affect future groundwater water for the City.

In the Utilities chapter, the perfunctory discussion of the City's existing Delta Water Supply Project and planned expansions must be augmented to tell the whole story. There must be a full discussion about how the City's extraction of delta water is contingent on discharge volumes from the City of Stockton Waste Water Treatment Plant.

The text currently states:

COSMUD also obtains surface water from the San Joaquin Delta via the Delta Water Supply Project (DWSP) at the DWSP intake facility on the San Joaquin River west of the northern part of the EIR Study Area. The DWSP includes a water treatment plant with 30 mgd capacity. The DWSP is expected to be expanded to 90 mgd capacity by 2035, with annual production of about 44.6 mgd. DEIR at 4.15-5.

The following text from the City's 2015 Urban Water Management Plan should be summarized and inserted into the DEIR.

The City has developed a new surface water supply, Delta water at the DWSP intake facility, from the San Joaquin River. The objective of this supply is to achieve a long-term reliable water supply from the Delta for existing and future customers. The City has rights to Delta water because portions of the COSMA fall within the legally defined Delta and the area of origin. The City's water rights application addressed a long-term planning horizon through the year 2050, requesting an ultimate diversion of 160 million gallons per day (mgd) (125,900 ac-ft/yr). The State Water Resources Control Board (SWRCB) divided the water rights application into two separate applications, Application 30531A and 30531B. Application 30531A covers the initial phase of the DWSP up to 30 mgd (33,600 ac-ft/yr) and the place of use is confined to the current 1990 General Plan boundary. The initial phase was granted a water right under California Water Code Section 1485. The City has a permit from the SWRCB issued on March 8, 2006 for a 33,600 ac-ft/yr supply from the Sacramento/San Joaquin Delta.

The DWSP intake and water treatment plant was operational in 2012 with an initial capacity of 30 mgd (33,600 ac-ft/yr). The projected capacity of the DWSP by 2035 is 90 mgd with an annual production of approximately 50,000 ac-ft/yr. The DWSP will expand as needed up to 120 mgd provided water rights are granted.

The City's supply from the San Joaquin River is curtailed annually from February through June of each year due to U.S. Department of Fish and Wildlife Service and Department of Fish and Game restrictions. California Water Code (CWC) Section 1485 Water Rights allows the City to take out of the Delta as much water as the City's wastewater treatment plant discharges into the Delta. This quantity, which fully covers the 33,600 ac-ft/yr, is not restricted as long as the same amount of wastewater is discharged into the Delta. Section 1485 water may be subject to pumping restriction in some months due to fish protection. UWMP at 5-6.

**A13-56  
cont.**

The DEIR goes on to state that "Existing and forecast CWSC and COSMUD water supplies are shown in Table 4.15-1. DEIR at 4.15-5. As shown in Table 4.15-2, between 2015 and 2040, purchased water is estimated to decrease from about 51 percent to 35 percent of water sources serving the EIR Study Area; surface (Delta) water is estimated to increase from about 20 percent to 41 percent; and groundwater is estimated to decrease from about 28 percent to 24 percent. DEIR at 4.15-5."

Table 4.15-2 indicates that significant new volumes of surface water will be needed to serve growth by 2040, and much more water will be needed to serve the additional growth forecast in the City water service area after 2040 (an impact that is ignored in this analysis). The table indicates that the water supply from the Delta Water Supply Project is assumed to increase from the permitted 33,600 acre-feet per year to 50,000 afy in year 2040. However, that increase has not been permitted by the State and may never be approved. Even if it were approved, it may be approved with very serious restrictions that will limit water extraction by the City to only portions of the year.

**A13-57**

The status of the second application to the State should be updated. The DEIR analysis must also include a realistic assessment of what would happen if the second application to the State water Control Board to increase supplies pumped by the City from 33,600 to 50,000 afy were denied or if conditions placed on an approval precluded the use of water for year round uses such as new homes and businesses. The DEIR should discuss and analyze the likelihood that the second permit will be approved, and the likelihood that much stricter water supply and quality standards will be applied to all Delta water users due to the twin tunnels proposal (California Water Fix project), the Basin Plan pending before the State Water Control Board, and other related regulations. For example, if the approved Basin Plan requires additional downstream flows to mitigate Delta impacts the additional surface water quantities that the City is counting on purchasing or pumping may not be available. The DEIR should also discuss the potential of pending and sustained litigation over the Water Fix project to upset the current and future extraction of municipal water supplies from the Delta.

The DEIR analysis must also examine the relationship between existing and projected discharges at the City wastewater treatment plant. The condition of the permit from the State allows the City to take out of the Delta as much water as the City's wastewater treatment plant

**A13-58**

discharges into the Delta. Will there be sufficient discharges in the coming years to ensure that the assumptions about future water supply from the Delta are accurate?

**A13-58  
cont.**

Impact UTIL-1 states that “Implementation of the proposed project would have sufficient water supplies available to serve the proposed project from existing entitlements. The text goes on to state “Development allowed by the proposed General Plan is forecast to increase water demands in the EIR Study Area by about 17.7 mgd to total 66.3 mgd, as shown in Table 4.15-5. The increase would be about 36 percent over existing water demands, which are approximately 48.6 mgd. About 82 percent of the net increase in water demands would occur in COSMUD’s service area, that is, the northern and southern parts of the EIR Study Area. COSMUD’s service area also covers the majority of the approved and pending projects, which, as shown in Table 4.15-5, constitute the majority of the net increase in projected water demands that would occur in the SOI by GPU Horizon Year 2040.” DEIR at 4.15-8 and 9.

**A13-59**

This conclusion is not accurate since only a portion of the growth (about one-third) allowed by the Plan is evaluated. Also, the impact statement refers to “existing entitlements” which cannot include the 50,000 afy from the Delta because it has not been approved by the State. Finally, the City is required by State law to complete a detailed Water Supply Assessment for the proposed General Plan since it is a significant General Plan Amendment that requires an EIR. Normally, a separate detailed Water Supply Assessment is completed, attached as an appendix to the EIR, and its conclusions are summarized in the EIR chapters. The DEIR contains no such document and it appears the City has not prepared a study. The requirements for the Water Supply Assessment were enacted in Senate Bill 610 (Costa, 2001) and are codified in Section 10910 of the State Water Code.

**A13-60**

**A13-61**

The brief and conclusory analysis on water supplies contained in the DEIR does not comply with the technical requirements of State law. The DEIR relies entirely on a brief summary of the adopted 2015 Urban Water Management Plans for Cal Water Service and the City of Stockton. These UWMPs are based on land use data and projections that are not the same as the growth allowed under this proposed General Plan. The omission of a legally adequate Water Supply Assessment must be corrected and the DEIR must be recirculated to give members of the public an opportunity to review the study.

**A13-62**

**Conclusion**

We will continue to insist that the city approve an updated General Plan and accompanying environmental impact report in conformance with State law. We have offered ample evidence that the existing DEIR, in its current form, does not meet the requirements of CEQA. The city must direct staff and the consultant to modify the draft plan and the DEIR to meet the State mandate for full disclosure of all impacts and recommend specific measures for all growth allowed under this General Plan, not just some of it.

**A13-63**

Thank you for your consideration of these important matters. We look forward to much more discussion and debate about these issues.

Very truly yours,

ss/Eric Parfrey  
Chair, CCG and  
Chair, Sierra Club California Executive Committee

cc: Stockton City Council  
Stockton Planning Commission  
Andrew Chesley, SJCOG  
San Joaquin County Board of Supervisors  
State Attorney General  
Rachel Hooper, Shute, Mihaly, Weinberger



2040 GENERAL PLAN UPDATE AND UTILITY MASTER PLAN SUPPLEMENTS  
 DRAFT ENVIRONMENTAL IMPACT REPORT  
 CITY OF STOCKTON

**PROJECT DESCRIPTION**

**TABLE 3-3 2040 DEVELOPMENT BY STUDY AREA**

| Study Area #/Name                     | Net New Single-Family Units (Full Buildout) | Percent Applied to 2040 | Net New Single-Family Units (2040) | Net New Multi-Family Units (Full Buildout) | Percent Applied to 2040 | Net New Multi-Family Units (2040) | Net New Commercial Square Feet (Full Buildout) | Percent Applied to 2040 | Net New Commercial Square Feet (2040) | Net New Industrial Square Feet (Full Buildout) | Percent Applied to 2040 | Net New Industrial Square Feet (2040) |
|---------------------------------------|---|-------------------------|------------------------------------|--|-------------------------|-----------------------------------|--|-------------------------|---------------------------------------|--|-------------------------|---------------------------------------|
| 1. Eight Mile Rd                      | 3,940                                       | 35%                     | 1,380                              | 25,350                                     | 5%                      | 1,200                             | 197,000  | 20%                     | 39,000                                | 74,095,000                                     | 0%                      | 0                                     |
| 2. Pacific Ave Corridor               | 0   | 0%                      | 0                                  | 440  | 25%                     | 110                               | 188,000  | 50%                     | 94,000                                | 0  | 0%                      | 0                                     |
| 3. West Ln and Alpine Rd              | 80  | 100%                    | 80                                 | 2,720                                      | 25%                     | 680                               | 1,294,000                                      | 25%                     | 323,000                               | 0  | 0%                      | 0                                     |
| 4. Port/Waterfront                    | 20  | 100%                    | 20                                 | 2,210                                      | 80%                     | 1,770                             | 6,800,000                                      | 30%                     | 2,040,000                             | 2,323,000                                      | 25%                     | 581,000                               |
| 5. El Dorado/Center Corridors         | 0   | 0%                      | 0                                  | 1,500                                      | 80%                     | 1,200                             | 4,367,000                                      | 30%                     | 1,310,000                             | 0  | 0%                      | 0                                     |
| 6. Miner/Weber Corridors <sup>a</sup> | 0   | 0%                      | 0                                  | 1,560                                      | 80%                     | 1,250                             | 2,926,000                                      | 50%                     | 1,463,000                             | 0  | 0%                      | 0                                     |
| 7. Wilson Way Corridor                | 0   | 0%                      | 0                                  | 940  | 25%                     | 230                               | 1,213,000                                      | 50%                     | 607,000                               | 0  | 0%                      | 0                                     |
| 8. I-5/Highway 4 Interchange          | 0   | 0%                      | 0                                  | 820  | 80%                     | 660                               | 777,000  | 50%                     | 389,000                               | 0  | 0%                      | 0                                     |
| 9. Railroad Corridor at California St | 0   | 0%                      | 0                                  | 1,680                                      | 80%                     | 1,340                             | 5,197,000                                      | 25%                     | 1,299,000                             | 0  | 0%                      | 0                                     |
| 10. I-5 and Charter Way               | 90  | 100%                    | 90                                 | 980  | 10%                     | 100                               | 535,000  | 25%                     | 134,000                               | 98,000   | 85%                     | 84,000                                |
| 11. Charter Wy/MLK Jr Blvd Corridor   | 0   | 0%                      | 0                                  | 790  | 50%                     | 400                               | 1,619,000                                      | 20%                     | 324,000                               | 0  | 0%                      | 0                                     |
| 12. Airport Way Corridor              | 0   | 0%                      | 0                                  | 430  | 25%                     | 110                               | 274,000  | 75%                     | 205,000                               | 5,475,000                                      | 25%                     | 1,369,000                             |
| 13. Mariposa and Charter              | 0   | 0%                      | 0                                  | 570  | 0%                      | 0                                 | 324,000  | 25%                     | 81,000                                | 0  | 0%                      | 0                                     |
| 14. East Weston Ranch <sup>b</sup>    | 0   | 0%                      | 0                                  | 610  | 0%                      | 0                                 | 574,000  | 75%                     | 431,000                               | 0  | 0%                      | 0                                     |
| 15. South of French Camp Rd           | 0   | 0%                      | 0                                  | 0  | 0%                      | 0                                 | 0  | 0%                      | 0                                     | 0  | 0%                      | 0                                     |
| 16. E French Camp Rd                  | 0   | 0%                      | 0                                  | 0  | 0%                      | 0                                 | 0  | 0%                      | 0                                     | 0  | 0%                      | 0                                     |
| Outside of Study Areas <sup>c</sup>   | 16,360                                      | 9%                      | 1,500                              | 29,810                                     | 0%                      | 0                                 | 19,487,000                                     | 0%                      | 0                                     | 126,805,000                                    | 0%                      | 0                                     |
| <b>Grand Total<sup>d</sup></b>        | <b>20,480</b>                               |                         | <b>3,060</b>                       | <b>70,400</b>                              |                         | <b>9,040</b>                      | <b>45,773,000</b>                              |                         | <b>8,739,000</b>                      | <b>208,796,000</b>                             |                         | <b>2,033,000</b>                      |

a. Excludes Open Window approved project.  
 b. Excludes Weston Ranch Town Center approved project.  
 c. Excludes approved/pending projects.  
 d. Numbers do not always add up due to rounding.  
 Source: PlaceWorks, 2017.

# Report on the Status of Rubberized Asphalt Traffic Noise Reduction in Sacramento County



Prepared For:

**Sacramento County  
Public Works Agency - Transportation Division**

Prepared by:

**Sacramento County  
Department of Environmental Review and Assessment**

And

**Bollard & Brennan, Inc.  
Consultants in Acoustics and Noise Control Engineering**

November 1999

# TABLE OF CONTENTS

|   |   |
|---|---|
| EXECUTIVE SUMMARY .....   | 1   |
| INTRODUCTION .....  | 2   |
| HISTORY OF NOISE REDUCING PAVEMENT .....  | 3   |
| THE PROCESS OF PRODUCING RUBBERIZED ASPHALT .....                               | 4   |
| Wet Process.....  | 4   |
| Dry Process .....   | 5   |
| CURRENT USES OF RUBBERIZED ASPHALT .....  | 5   |
| STUDIES OF RUBBERIZED ASPHALT OUTSIDE OF SACRAMENTO COUNTY .                    | 10  |
| Rubberized Asphalt Studies in Other California Counties .....                   | 10  |
| National Rubberized Asphalt Studies .....                                       | 10  |
| Global Studies.....   | 11  |
| SACRAMENTO COUNTY RUBBERIZED ASPHALT NOISE STUDIES .....                        | 13  |
| Overview of Noise and Rationale for Rubberized Asphalt Noise Studies .....      | 13  |
| How Traffic Noise is Generated and the Implications for Rubberized Asphalt..... | 13  |
| Traffic Noise Prediction Model .....  | 14  |
| Traffic Noise Prediction Model Calibration .....                                | 15  |
| Traffic Noise Prediction Model Inputs .....                                     | 15  |
| Specific Rubberized Asphalt Test Procedure .....                                | 15  |
| Test Roadways Evaluated in the Sacramento County Studies.....                   | 16  |
| Elapsed Time Between Measurements .....   | 16  |
| Asphalt Compaction .....  | 17  |
| Noise Measurement Duration, Equipment Locations and Configurations..            | 17  |
| Atmospheric Conditions .....  | 18  |
| Traffic Volume, Speed and Heavy Truck Usage.....                                | 18  |
| Specific Sacramento County Rubberized Asphalt Test Results .....                | 19  |
| CONCLUSIONS OF THE STUDIES CONDUCTED IN SACRAMENTO COUNTY ..                    | 20  |
| Appendix A .....  | Acoustical Terminology                                |
| Appendix B .....  | Noise Standards Commonly Applied in Sacramento County |
| Appendix C .....  | References Consulted                                  |

# ACKNOWLEDGEMENTS

## **Sacramento County Public Works Agency**

### **Transportation Division**

906 G. Street, Suite 510

Sacramento, California 95814

(916) 874-6291

Chief: Thomas Zlotkowski

Senior Engineer: Theron Roschen

## **Sacramento County Department of Environmental Review and Assessment**

### **Public Projects Division**

827 7th Street, Room 220

Sacramento, California 95814

(916) 874-7914

Environmental Coordinator: Dennis Yeast

Division Manager: Bob Caikoski

Project Leader: Antonia Barry

Student Intern: Melinda Coy

## **Bollard & Brennan, Inc.**

### **Consultants in Acoustics and Noise Control Engineering**

3805 Taylor Road, Suite 2

Loomis, California 95650

(916) 660-0191

President: Paul Bollard

---

## EXECUTIVE SUMMARY

This report is a joint study prepared for the Sacramento County Public Works Agency, Transportation Division by the Sacramento County Department of Environmental Review and Assessment and Bollard and Brennan, Inc., consultants in acoustics and noise control engineering.

The purpose of this report is to document the effectiveness of rubberized asphalt as a traffic noise mitigation measure. Rubberized asphalt is a bituminous mix, consisting of blended aggregates, recycled rubber and binding agents. The rubber is often obtained from used tires. Studies conducted locally, nationally, and internationally, have shown that rubberized asphalt can reduce the noise pollution that is associated with roadway traffic.

The specific findings of this analysis are based primarily on a series of traffic noise level measurements conducted along the Alta Arden Expressway, between Howe and Watt Avenues, from 1993 to the present. Although similar noise measurements have been conducted along a segment of Antelope Road, the smaller number of variables affecting the measured traffic noise levels along the Alta Arden Expressway before and after paving with rubberized asphalt made that roadway a more statistically reliable test subject. Therefore, this analysis focuses on the series of test results for Alta Arden Expressway.

Bond Road between Stockton Boulevard and Florin Road, was used as the control site for conventional (non-rubberized) paving. Although the Bond Road test segment was widened at the time of paving with conventional asphalt, the relationship of the roadway to the noise measurement site remained relatively unchanged.

The conclusions of the 6-year study indicate that the use of rubberized asphalt on Alta Arden Expressway resulted in an average four (4) decibel reduction in traffic noise levels as compared to the conventional asphalt overlay used on Bond Road. This noise reduction continued to occur six (6) years after the paving with rubberized asphalt. This degree of noise attenuation is significant, as it represents a 60% reduction in traffic noise energy, and a clearly perceptible decrease in traffic noise. This traffic noise attenuation from rubberized paving is similar to the results documented in several non-related studies conducted in recent years at other locations, both nationally and internationally.

The conclusions of this study are based on tests conducted in Sacramento County on the Alta Arden Expressway and Bond Road. Attenuation provided by rubberized asphalt may vary in other locations with different climates and different percentages of medium duty and

---

heavyduty trucks.

## **INTRODUCTION**

The main theme of this report is the effectiveness of rubberized asphalt as a traffic noise mitigation measure. Locally collected noise information is supplemented with general noise test results from various locations, both nationally and internationally, where other jurisdictions are exploring the use of rubberized asphalt. However, this report does not attempt to reproduce the result of those other studies herein. The interested reader is encouraged to contact those entities or jurisdictions where other studies were performed for further information. This report is primarily meant to provide information on the studies conducted in Sacramento County.

In addition to the various noise test results, this report offers an overview of the factors that contribute to traffic noise generation. The report also contains the Sacramento County, State and Federal noise standards, which mandate the consideration of noise abatement measures in cases where traffic noise levels exceed acceptable limits. The noise standards are provided to illustrate the importance that is given to traffic noise impacts in Sacramento County, which in turn has led to substantial requirements for traffic noise abatement.

In recent years, Sacramento County has relied upon noise barriers as the primary noise mitigation option, and often times the only viable noise mitigation option, for roadway improvement projects in the County. As a result, a substantial number of noise barriers have, and continue to be, constructed in areas where traffic noise is determined to be excessive. Concerns regarding the proliferation of noise barriers has resulted in the investigation of rubberized asphalt paving as a viable noise mitigation alternative. This investigation has been ongoing since the paving of Alta Arden Expressway with rubberized asphalt in October of 1993. This report summarizes the results of Sacramento County's ongoing investigation to date.

---

## HISTORY OF NOISE REDUCING PAVEMENT

The history of adding recycled tire rubber to asphalt paving material can be traced back to the 1940's when the U.S. Rubber Reclaiming Company began marketing a devulcanized recycled rubber product, called Ramflex™, as a dry particle additive to asphalt paving mixture. In the mid-1960's, Charles McDonald began developing a modified asphalt binder using crumb rubber. This product was marketed by Sahuaro Petroleum and Asphalt Company as Overflex™.

The Arizona Refining Company Inc., created the second modified binder in the mid-1970's, replacing a portion of the crumb rubber with devulcanized recycled rubber and marketing it under the name Arm-R-Shield™. Both Overflex™ and Arm-R-shield™ were patented and eventually brought under single ownership. The companies marketing these two products founded a trade association known as the Asphalt Rubber Producer Group in the mid-1980's. Ramflex™ disappeared from the market when its parent corporation sold the U.S. Rubber Reclaiming Company.

In addition to the US, Sweden also made tremendous contributions to the development of rubberized asphalt. In the 1960's, two Swedish companies began developing an asphalt paving surface mixture that would resist studded tire and chain wear. The mixture included a small amount of crumb rubber as an aggregate and was named Rubit™. In the late 1970's this product was introduced and patented in the United State as PlusRide™. It evolved in a series of field projects in Alaska and other states from 1979 through 1985. PlusRide™ has been managed by a number of firms and is presently marketed by Envirotire, Inc.

In recent years there has been a great surge to make use of the used tires that are being stockpiled all around the world. This is primarily due to the advancement in technology and realization of benefits associated with application and reduction of used tires. Because of the increase in the number of tires accumulating around the world, and environmental hazards associated with them, more nations are looking for ways to make use of this tremendous resource.

## THE PROCESS OF PRODUCING RUBBERIZED ASPHALT

Rubberized asphalt is a process of incorporating crumb rubber (CRM) with asphalt paving materials. Crumb rubber consists of recycled rubber that has been reduced in sizes less than 6.3mm. Crumb rubber can be incorporated by a wet process or a dry process. In 1991, the Federal Highway Administration (FHWA) introduced standard terminology to improve the ability to communicate the experience of highway agencies when evaluating CRM processes. Figure 1 defines the terminology and summarizes it.

**Figure 1**

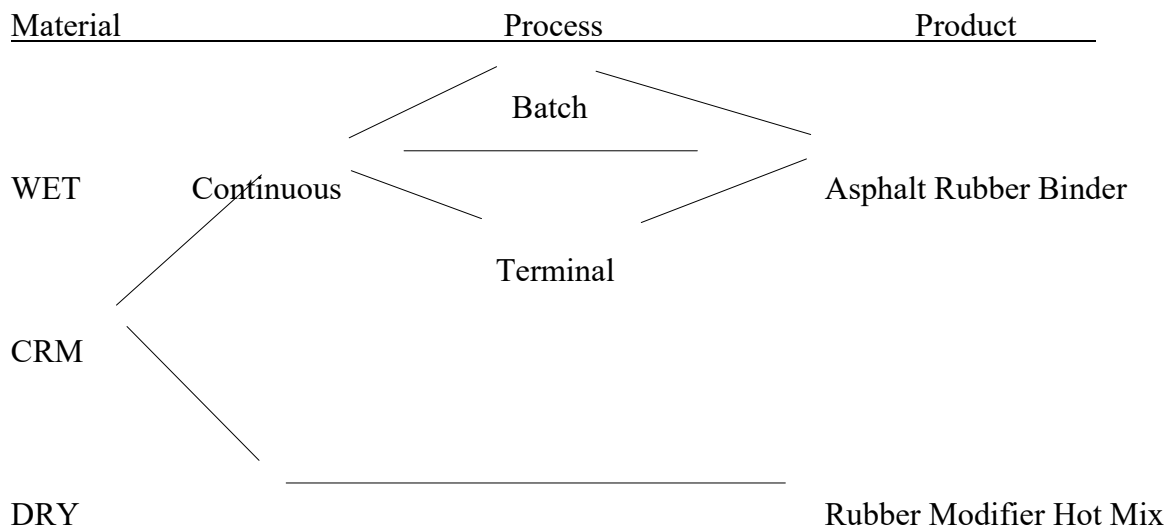

### ***Wet Process***

Wet process refers to modification of asphalt cement binder with 5-25%wt of fine tire rubber crumb modifier (CRM) at an elevated temperature. The wet process includes the blending of the crumb rubber with the asphalt. The method of blending can be divided into three categories: batch blending, continuous blending and terminal blending. Batch blending defines those wet process technologies that mix batches of CRM and asphalt in production. Continuous blending describes those wet process technologies that have a continuous production system. Terminal blending is associated with wet process technologies that have product with extended storage (shelf life) characteristics and are produced at an asphalt



---

cement supply terminal.

### ***Dry Process***

The dry process includes mixing the rubber particles with aggregates prior to addition to asphalt. This process provides a way to blend the crumb rubber with the asphalt and aggregate without the use of the special equipment needed in the wet process. There are some technical problems associated with this method, but new technologies are being introduced that are improving the process. Currently, the only process approved for use by the California Department of Transportation (Caltrans) is the wet process.

### **CURRENT USES OF RUBBERIZED ASPHALT**

Although the idea of using old tires to make asphalt was started in United States in 1940's the idea has not gained much momentum. One reason is due to the FHWA position against the use of the rubberized asphalt as a noise mitigation measure. Rubberized asphalt continues to be labeled as experimental and thus funding for its use can be hard to obtain. Other reasons for its less than wide spread use include state preferences for the use of older methods for pavement, 'impostor' projects that don't adhere to standards, thereby resulting in failures, and the Interstate Surface Transportation Efficiency Act (ISTEA), mandate.

ISTEA provides federal funding through the FHWA for transportation projects and was superceded by Tea-21 in May of 1999. The ISTEA mandate holds that funding must be used to research and implement studies on the use of rubberized asphalt.

ISTEA, Section 1038(d), mandated the States use recycled tires in asphalt paving. Through 1995, Congress provided moratoriums on implementation but the section remained as federal law. There were also specific penalties for those States unable to comply. In 1995, Section 1038 was modified by striking subsection (d). This eliminated the rubber mandate and all associated penalties. It was further amended to require research and development of tests and specifications for rubberized asphalt. This research requirement was aimed primarily at cost and performance; traffic noise reduction was not an issue.

There were two consequences resulting from this mandate. First, the mandate caused political fallout within the industry and thus created a rift within its parent industry. Secondly, the revocation of this mandate caused funding and projects to be dropped in favor of more traditional practices. However, the FHWA allows the use of rubber asphalt where it is both cost effective and it can be properly engineered mainly as a tire waste management

---

mitigation program. It is not allowed as a noise mitigation measure in National Environmental Policy Act (NEPA) documents.

The use of rubberized asphalt is becoming more popular as countries around the world are faced with the problem of noise pollution and excess used tires. They are beginning to rely on rubberized asphalt to mitigate the noise problems associated with roadway transportation. This phenomenon was first noted in Brussels, Belgium, in 1981, in asphalt rubber hot mix called "Drainasphalt". The study showed a dramatic reduction in traffic noise levels. As a result, numerous countries around the world have started noise level studies to evaluate the validity of claims being made.

In 1984, an investigation was made by the French to determine hydrostatic pressure in and under Drainasphalt on City Street along the Seine River. Their findings showed a reduction of 3 to 5 dB with no trucks, and a 2 to 3 dB reduction with five percent trucks. As a result of their findings, the researcher made a proposal to overlay the Paris Loop with open graded Asphalt-Rubber.

As a result of these findings, other countries, such as Canada, were convinced to do further research on the benefits of using rubberized asphalt. In 1994-1995 Canada started the full-scale use of the rubberized asphalt. In the full-scale phase six streets were paved using rubberized asphalt. Table 1 lists international projects carried out or under way.

---

**Table 1**  
**Countries Used/Using Rubberized Asphalt**  
**and Resulting Noise Reduction**

| Country     | Year | Reported Noise level Reduction |
|-------------|------|--------------------------------|
| Belgium     | 1981 | 8-10 dB (65-85%)               |
| Canada      | 1991 | Shown noise reduction          |
| England     | 1998 | Project not completed          |
| France      | 1984 | 2-3dB/3-5dB (50-75%)           |
| Germany     | 1980 | 3dB (50%)                      |
| Austria     | 1988 | 3+ dB                          |
| Netherlands | 1988 | 2.5dB                          |

Within the US, some of the cities and counties that are currently evaluating the use of rubberized asphalt include Tucson AZ, Phoenix AZ, Sacramento CA, Orange CA, Los Angeles CA and San Diego CA.

**Table 2**  
**States Using Rubberized Asphalt and Resulting Noise Reduction**

| State      | Counties & Cities  | Year | Noise Level Reduction         |
|------------|--------------------|------|-------------------------------|
| Arizona    | Phoenix, AZ        | 1990 | 10dB (88%)                    |
|            | Tucson, AZ         | 1989 | 6.7dBs (78%)                  |
| California | Sacramento County  | 1993 | 7.7 - 5.1 dB                  |
|            | Orange County      | 1992 | 3-5 dB on Open Graded asphalt |
|            | Los Angeles County | 1991 | 3-7 dB                        |
|            | San Diego County   | 1998 | Project in process            |
| Texas      | San Antonio        | 1992 | Data not Provided             |
| Oregon     | Corvallis          | 1994 | Data not Provided             |

\* Table is not comprehensive. Studies may have taken place in other states.

Since 1992, rubberized asphalt has been used in Sacramento County. Table 3 shows the locations where it has been used.

**Table 3**  
**Rubberized Asphalt Usage in Sacramento County**

| Year/s      | Location                           |
|-------------|------------------------------------|
| 1992 / 1994 | Auburn Boulevard                   |
| 1992        | Folsom Boulevard                   |
| 1992 / 1993 | Alta Arden Expressway              |
| 1992        | Arden Way                          |
| 1992        | South Watt Avenue                  |
| 1992 / 1995 | Watt Avenue                        |
| 1002        | Van Maren Way                      |
| 1992        | Sunset Ave                         |
| 1993        | Air Base Drive                     |
| 1993        | Chase Drive                        |
| 1993        | Coloma Road                        |
| 1994        | Antelope Road                      |
| 1996        | Marconi Avenue at Watt Avenue      |
| 1996        | Arden Way at Watt Avenue           |
| 1996        | Greenback Lane at Hazel Avenue     |
| 1996        | Fair Oaks Boulevard at Watt Avenue |
| 1996 / 1998 | Elkhorn Boulevard                  |
| 1997        | Orange Grove Avenue                |
| 1997        | Roseville Road                     |
| 1997        | Sly Parkway                        |
| 1998        | Engle Road                         |
| 1998        | San Juan Avenue                    |
| 1999        | Calvine Road                       |

---

## STUDIES OF RUBBERIZED ASPHALT OUTSIDE OF SACRAMENTO COUNTY

### *Rubberized Asphalt Studies in Other California Counties*

Rubberized asphalt has been studied in other California counties outside of Sacramento. Orange County studied the effectiveness of rubberized asphalt as a noise mitigation measure in a report entitled Mixed Roadway Surface Noise, prepared by Mestre Greve Associates in February of 1992. The City of Thousand Oaks also conducted a study in 1992 entitled Asphalt Rubber Overlay Noise Study, prepared by Acoustical Analysis Associated, Inc. Both studies determined that rubberized asphalt successfully mitigated traffic noise.

The study conducted for the County of Orange looked at the difference in noise levels between four different pavement types: dense grade asphalt, rubber asphalt (gap graded), rubber asphalt (open graded), and open grade (with latex). The goal of this analysis was to eliminate the effect due to different traffic conditions at each segment of roadway thus resulting in a different noise level due specifically to the asphalt type. *The study concluded that rubber asphalt-open graded was 3.9 dBA quieter than new dense grade asphalt.*

The noise study conducted for the City of Thousand Oaks measured the reduction in traffic noise levels experienced due to resurfacing. The street conditions before resurfacing were poor and therefore, noise reduction due to the new paving was striking. *Noise reduction on the six sites tested ranged from 3-7 dBA, depending on traffic and speed. When compared with the new standard asphalt, rubberized asphalt was found to be 2-5 dBA quieter.*

### *National Rubberized Asphalt Studies*

On a national scale, rubberized asphalt has been studied by many states as well as the federal government. Arizona has been the leader in the production and use of rubberized asphalt. In March 1990, Western Technologies Inc. performed a sound level survey to determine the noise levels produced during peak traffic flow on different types of pavement, including rubberized asphalt. In November of 1995 the Texas Department of Transportation conducted a study on the crumb rubber modifier used in rubberized asphalt as a successful method to reduce tire noise. Finally, the National Research Council conducted a study in 1997 entitled the Relationship between Pavement Surface Texture and Highway Traffic Noise.

---

Two studies were conducted in Arizona. One was prepared for the City of Phoenix and the other was prepared for the City of Tucson. The study in the City of Phoenix compared standard chip seal asphalt laid in 1984 and rubberized asphalt that was laid in 1989. *The study concluded that there was an approximate 10 dBA reduction in noise with the rubberized asphalt compared with the chip seal asphalt.* The study prepared for the City of Tucson compared asphalt rubber concrete pavement and standard concrete pavement. *The study showed that the asphalt rubber concrete was 6.7 dBA quieter than the concrete pavement.*

In 1995, the Texas Transportation Institute conducted a study to identify potential problems with the current rubberized asphalt mix design, develop recommendations on those problems, develop recycling guidelines, and evaluate alternatives. Researchers monitored CRM mixtures paved in 1992 and 1993 in San Antonio, Texas. *The results of these tests concluded that rubberized asphalt performed well in construction practices, and that the rubberized asphalt mixes gives a higher durability with better stability than dense-grade mixes.*

The National Research Council conducted a study showing the effect of different surface types on noise levels. *The Council studied many types of roadway surfaces and determined that open graded asphalt showed the greatest potential for noise reduction when compared to dense graded asphalt.* The study examined research done by the Kansas Department of Transportation in 1990/1991, that studied the effects of rubberized asphalt. The results in Kansas showed that the open graded asphalt always showed a decrease in noise level. In contrast, when the asphalt rubber pavement was compared to the asphalt surface, there were both reductions and increases in noise level. *Thus, the results of this Kansas study did not show a clear noise reduction trend with rubberized asphalt.* However, the study done by the National Research Council did not examine any other research than the Kansas study.

### ***Global Studies***

Rubberized asphalt is a process that is not only of interest in the United States but also globally. In 1995, the Canadian Technical Asphalt Association performed a study for British Columbia on rubberized asphalt. Their study entitled, The Full Scale Evaluation of Rubberized Asphalt Concrete in British Columbia, was a response to the need for improvement of binders in the road building industry. In a paper done by Netherlands researchers, entitled Open Grade Rubberized Asphalt for Traffic Noise Reduction in Urban Areas, research was conducted to analyze the development of rubberized asphalt as a

---

mitigation measure. Other studies have been done in Great Britain, West Germany, Belgium, and other European Countries.

The study conducted in British Columbia compared conventional pavement binders to Rubberized Asphalt (Rub-Arb [TM]) in various locations throughout British Columbia over a period of five years. This study concluded that within the laboratory, the asphalt rubber binder showed improved properties at extreme temperatures compared to convention asphalt. This study also concluded, that modified asphalt rubber binders can be manufactured for a wide range of climate conditions and requirement, it is more flexible at low and sub-zero temperatures, and that the thickness of the asphalt rubber concrete overlay can be reduced from the traditional 50mm overlay down to 38mm of modified asphalt rubber concrete.

In Dordrecht, Belgium a test was conducted using open graded rubberized asphalt in order to study the effectiveness of rubberized asphalt on noise. In this study the researchers concluded that it is possible to design an asphalt mix to reduce traffic noise in urban situations where the traffic noise is dominant. *The study found, that a noise reduction can be achieved of between 2.1 and 3.2 dBA at the speeds of around 50 km/h.*

Additional studies have been conducted in other European countries. *The Societe des Autoroutes du Nord et de l'Est de la France, Paris conducted a study that showed a noise reduction level of 2-3 dBA with rubberized asphalt along the Seine River.* In a paper presented at the 1988 Asphalt-Rubber Conference in Graz, Austria, Helmut Prager, Engineer of Austrian Highways and Bridges showed how the rubber overlay provides better noise reduction. Finally, in Bonn, Germany a study showed that using rubberized asphalt as a sound mitigation measure is more cost effective than using sound barriers. *Most of these studies concluded that rubberized asphalt could reduce noise by 2-3 dBA with few technical problems.*

Finally, The European Commission Green Paper, published in the June 1997 edition of Noise/News International, cites the following on Page 87:

“Low-noise porous road surfaces have been the subject of much research. These porous road surfaces reduce both the generation and propagation of noise by several mechanisms - which can be related to the open structure of the surface layer. Results have shown that the emission noise levels can be reduced from levels generated on equivalent non-porous road surfaces by between 3-5 dB(A) on average; by optimizing the surface design, larger noise reductions are feasible. At present, the cost of porous asphalt surfacing is higher than conventional surfaces (for resurfacing, but for new roads, the cost is minimal), but may drop



---

as contractors gain experience with porous surfaces. The material is also less durable. However, improvements are being made to durability and, in many countries, these materials are already being used as part of normal road construction in noise-sensitive areas.”

## **SACRAMENTO COUNTY RUBBERIZED ASPHALT NOISE STUDIES**

### ***Overview of Noise and Rationale for Rubberized Asphalt Noise Studies***

Noise pollution is the presence of intrusive and unwanted sounds that can seriously affect physical and psychological health. Some examples of the effects from noise pollution include the loss of hearing, anxiety, sleeplessness, aggression, increase in heart rate, and stress. Noise is measured by decibels (dBA) which are a logarithmic function of the ratio of the sound pressure squared over the reference pressure squared. Appendix A provides definitions of acoustic terminology used in this report. Levels of noise can range from very faint to painful and dangerous. For example, human breathing has a dBA of 10 which is considered very faint, office activities have an average dBA of 50, which is considered moderate, and a jet engine at 75ft has a dBA of 140 which is considered painful or dangerous. Because noise has potentially harmful effects, local, state, and federal agencies established noise thresholds beyond which traffic noise abatement must be considered.

Specific noise policies and standards which affect decisions regarding noise mitigation in Sacramento County are provided in Appendix B. It is evident from the various noise standards shown in Appendix B which apply to both development and roadway construction projects in Sacramento County, that this topic is given considerable attention in the environmental review process. The comprehensive County noise criteria has set standards that are often exceeded due to the ever increasing traffic noise levels that cannot be mitigated in traditional ways.

In light of this routine occurrence, the investigation into alternative noise abatement options, other than barriers, was considered to be warranted by Sacramento County. The initial studies of rubberized asphalt were commissioned by the County in 1993. Subsequent testing has been commissioned by the County twice since the initial tests were conducted in 1993. The following sections provide an overview of how traffic noise is generated, followed by the detailed rubberized asphalt test procedures and results of those tests.

### ***How Traffic Noise is Generated and the Implications for Rubberized Asphalt***

Traffic noise is generated primarily by the interaction of the tires and pavement, by the internal combustion engine of the vehicle, and by the engine exhaust. For automobiles, the

---

vast majority of the noise is generated by the interaction of the tires and pavement due to quieter engines and exhausts on modern vehicles. As a result, the effective noise source height for automobiles is considered to be zero (0) feet above the pavement, or right where the tire meets the road.

For medium duty trucks (2 axle trucks), there is a slightly larger contribution of noise from the engine compartment and exhaust pipe, so the effective noise source height is considered to be an average of those sources at two (2) feet above the pavement. For heavy trucks, not only is there a greater contribution of noise from the engine and exhaust, the exhaust stack opening is typically 11 feet or so above the pavement. Therefore, the effective noise source height for heavy trucks (3 axles or more), is considered to be eight (8) feet above the pavement, or the weighted average heights of the tires, engine and exhaust stacks.

This information pertaining to the noise generation of the various vehicle types is relevant in that rubberized asphalt is believed to obtain most of its' noise-reducing properties from a combination of the porosity and ductility of the rubberized roadway surface. As a result, tire noise is reduced, but engine and exhaust noise is not appreciably affected by the rubberized surface. Therefore, a roadway containing primarily automobile traffic would be expected to exhibit greater decreases in traffic noise following paving with rubberized asphalt that would a roadway that has a high percentage of heavy trucks.

### ***Traffic Noise Prediction Model***

A discussion of the method by which traffic noise is predicted is appropriately included in this report in that normalization of the traffic conditions present during the various noise measurement surveys was accomplished using the Federal Highway Administration Highway Traffic Noise Prediction Model (FHWA-RD-77-108). This normalization was required to isolate the effectiveness of the rubberized paving from the other variables affecting traffic noise generation which were present during the noise tests.

The FHWA Model is the traffic noise prediction model used by Sacramento County for traffic noise assessment. Several adaptations of the model have been developed, including Stamina and Sound 32, but these models are all fundamentally based on FHWA-RD-77-108.

The Federal Highway Administration is currently working on a new traffic noise prediction model which will theoretically replace the existing model, called the Traffic Noise Model (TNM). The TNM will reportedly make adjustments to traffic noise predictions based on roadway surface, but it is not known whether rubberized asphalt will be included in those surfaces. According to FHWA officials, the new TNM has been released and is in use by

---

various State Departments of Transportation (DOT's). It is likely that the new TNM will be required in situations where state or federal funding is involved, but it remains to be seen whether the complexity of the new model will be required for all traffic noise modeling efforts. At the time of this writing, the new TNM has not been adopted for use on California roadways by Caltrans.

### ***Traffic Noise Prediction Model Calibration***

The FHWA Model provides reasonably accurate traffic noise predictions under "ideal" roadway conditions. Ideal conditions are generally considered to be long straight roadway segments with uniform vehicle speeds, a flat roadway surface, good pavement conditions, a statistically large volume of traffic, and a unimpeded view of the roadway from the receiver location. However, ideal conditions are more the exception than the rule. As a result, it is often necessary to calibrate the FHWA Model through site-specific traffic noise level measurements and concurrent traffic counts.

The calibration process is performed by conducting concurrent traffic noise level measurements and vehicle counts, and comparing the measured level with that predicted by the Model for the given traffic conditions. This calibration procedure can be used to normalize the model output for varying traffic volumes, speeds, and truck compositions present during the noise measurement samples. Once these factors have been normalized, and the other variables affecting measured traffic noise levels (measurement equipment, distances, measurement technique, etc.) held constant, the differences between measured traffic noise levels before and after the paving with rubberized asphalt can be attributed to the roadway surface. This calibration procedure is the basis for the assessment of the noise-reducing properties of rubberized asphalt reported in this report.

### ***Traffic Noise Prediction Model Inputs***

Inputs to the FHWA Model include the number of vehicles per hour, the percentages of medium (2 axle) and heavy (3 or more axles) trucks, the average vehicle speeds, the distance between the traffic and receiver, and the characteristics of the intervening ground located between the roadway and the receiver (hard vs. soft site). During the calibration procedure described above, each of these factors was accounted for.

### ***Specific Rubberized Asphalt Test Procedure***

The fundamental methodology employed to determine the effectiveness of rubberized asphalt in reducing traffic noise levels in Sacramento County was to take the difference between

---

normalized traffic noise levels measured before and after paving of certain County roadways with rubberized and conventional asphalt overlays. As stated previously, there were several factors which influenced traffic noise generation which needed to be carefully considered in the analysis. Those factors, which include test roadway geometries, noise level measurement equipment location and configuration, atmospheric conditions, and traffic volume, speed, and heavy truck usage, are discussed below.

Test Roadways Evaluated in the Sacramento County Studies: The roadways selected by Sacramento County for assessment of the noise reducing properties of rubberized asphalt were Alta Arden Expressway between Howe and Watt Avenues, and Antelope Road between Auburn Boulevard and Old Auburn Road.

The paving of Alta Arden Expressway was completed in October of 1993, and was not associated with any other widening or reconstruction of that roadway. Therefore, the effects of rubberized asphalt in reducing traffic noise levels on this roadway could be studied without complications which arise from additional travel lanes, roadway realignment, or substantial changes in speeds which could result from such modifications.

The paving of Antelope Road with rubberized asphalt was completed following a roadway widening project on this roadway around April of 1995. As a result, the roadway geometry varied considerably between the pre- and post-paving noise level measurement periods. An effort was made to conduct the noise level measurements at the same distance from centerline before and after the paving. However, due to the widening, the near travel lane moved closer to the noise measurement sites, and speeds increased due to reduced congestion on this roadway. It is not specifically known to what degree the change in roadway geometry and speeds affected the noise measurement results. It is likely, however, that the post-paving noise levels were marginally higher than had the widening not occurred.

The paving of the Bond Road control segment with conventional (non-rubberized) asphalt occurred as part of a roadway widening project in August of 1995. As a result of the roadway realignment, the roadway geometry varied considerably between the pre- and post-paving noise level measurement periods. An effort was made to conduct the noise level measurements at the same distance from centerline before and after the paving. However, due to the widening, the near travel lane moved closer to the noise measurement sites, and speeds increased due to reduced congestion on this roadway as well. It is not specifically known to what degree the change in roadway geometry and speeds affected the noise measurement results. It is likely, however, that the post-paving noise levels were marginally higher than had the widening not occurred, as was the case for Antelope Road.

---

Elapsed Time Between Measurements: In the Alta Arden assessment, the traffic noise measurement survey was conducted one month prior to the paving with rubberized asphalt. The survey was repeated one month after paving, 16 months after paving, and six (6) years after paving with rubberized asphalt.

In the Antelope Road assessment, a period of 16 months elapsed between the “before” and “after” noise measurements. The asphalt overlay was installed approximately 10 months into this period, around April of 1995. Therefore, the “before” measurements were conducted approximately 10 months prior to the paving, and the “after” measurements were about 6 months after the paving with rubberized asphalt. The measurement survey was subsequently repeated in September of 1999, approximately 4 1/2 years after the paving with rubberized asphalt.

In the Bond Road assessment, the traffic noise measurement survey was conducted one month prior to the paving with conventional asphalt. The survey was repeated one month after paving, and again four (4) years after paving with conventional asphalt

Asphalt Compaction: Compaction of the asphalt overlay reduces the porosity of the road surface, which is believed to account for some of the noise reduction properties of the rubberized asphalt pavement. According to Sacramento County Public Works Agency, Transportation Division staff, the compaction of the paving material is essentially complete within one year of the paving. Therefore, the varying periods of time which elapsed between the paving of the test roadways and the follow-up measurements provides insight into the effects of compaction on the noise-reducing properties of rubberized asphalt. The specific findings regarding compaction follow in a later section of this analysis.

Noise Measurement Duration, Equipment Locations and Configurations: The noise level measurement surveys initially consisted of continuous measurements over a minimum period of 24-hours, and short-term (15-minute) measurements at various locations along each of the three test subject roadways.

The continuous noise level measurements were conducted to evaluate the differences in noise levels over 24-hour periods before and after the paving. A benefit of the continuous noise level measurements was that a statistically large sample of noise level data was obtained by which the effects of the rubberized asphalt could be generally evaluated. However, it was not practical to monitor and account for all of the factors which affected the measured noise levels over the continuous sampling periods. Therefore, the findings based on the continuous

---

sampling are considered approximate and relevant only to the measurement periods which were not separated by extensive periods of time (i.e. periods during which traffic volumes and compositions would be expected to be relatively similar).

The short-term noise level measurements were conducted at various distances from the roadway centerlines. The continuous and short-term traffic noise measurements were conducted at a microphone height of 5 feet above ground. These measurements provided a statistically smaller sample of data by which to evaluate the effects of rubberized asphalt than did the results of the continuous monitoring, but traffic counts conducted during the short-term samples allow normalization of the measurement data as discussed previously in this report. The short-term sampling periods also allow for monitoring of all factors which affect the traffic noise measurement results. Therefore, the normalized results of the short-term samples are believed to provide a more reliable indication of noise reduction attained by the use of rubberized and conventional asphalt paving materials on the test subject roadways.

Larson Davis Laboratories (LDL) Model 870, 700 and 820 integrating sound level meters were used for the continuous and short-term noise level measurements. The meters were calibrated before use with LDL acoustical calibrators to ensure the accuracy of the measurements. The equipment used meets all applicable specifications of the American National Standards Institute for precision sound level measurement systems. The equipment configurations were identical for all of the before and after measurements, with the meters set to the A-weighting network and slow response.

Atmospheric Conditions: Weather conditions were considered to be effectively similar for the before and after short-term traffic noise level measurements at each location. However, due to the close proximity of the noise level measurement microphones to the roadway centerlines, variations in weather conditions between the before and after noise level measurement periods are not believed to have significantly affected the measurement results. In all cases, the measurements were conducted on dry pavement.

Traffic Volume, Speed and Heavy Truck Usage: The continuous and short-term noise level measurements were conducted during typical weekday periods. Given the relatively long period between the initial and final noise measurement periods (4 to 6 years), the traffic volumes are believed to have varied significantly. Therefore, continuous noise level measurements were not used during the 1999 measurement surveys as use of such data could lead to erroneous conclusions regarding the noise-reducing properties of rubberized asphalt.

Traffic counts conducted during the short-term samples indicated that heavy truck traffic accounted for a very low percentage of the total traffic on each of the test subject roadways during those measurement periods. This finding is important in that heavy trucks generate considerably more engine and exhaust noise than automobiles, as stated previously. As a result of the low number of heavy trucks, the traffic noise was generated primarily by the interaction of tires and pavement, which is the component of the traffic noise intended to be isolated in this study.

Average vehicle speeds were observed to be marginally after paving at the test subject roadway locations where an additional lane was added, and fairly similar at the locations where the roadway geometry was not significantly altered. This assumption is based on observations and speedometer checks.

***Specific Sacramento County Rubberized Asphalt Test Results***

The normalized and averaged results of the various traffic noise surveys conducted on the three test subject roadways are presented in Table 4. The Table 4 data is presented in the form of changes in traffic noise levels relative to pre-paving conditions.

**Table 4  
Rubberized and Conventional Asphalt Noise Test Results  
Sacramento County Roadways**

| <b>Roadway</b>        | <b>Pavement Type</b> | <b>Duration of Time Elapsed After Paving</b> | <b>Change in Noise Levels, dB Leq</b> |
|-----------------------|----------------------|--|---------------------------------------|
| Alta Arden Expressway | Rubberized Asphalt   | 1 month                                      | -6 dB                                 |
|                       |                      | 16 months                                    | -5 dB                                 |
|                       |                      | 6 years                                      | -5 dB                                 |
| Antelope Road         | Rubberized Asphalt   | 6 months                                     | -4 dB                                 |
|                       |                      | 5 years                                      | -3 dB                                 |
| Bond Road             | Conventional Asphalt | 1 month                                      | - 2 dB                                |
|                       |                      | 4 years                                      | 0 dB                                  |

Notes:

The change noise levels shown in the far right column represents the average change in noise levels observed on the roadway test site at the nearest measurement locations to the roadways.

---

For Alta Arden and Antelope Road, the change represents the average noise reduction of three test locations for each roadway. For Bond Road, there was only one test location.

Due to the time elapsed between the earliest and latest noise measurements, the results were normalized for speed and traffic volume to isolate the noise-reducing properties of the paving materials.

---

Evaluation of the Table 4 data indicates that, immediately after paving the test roadways with rubberized and conventional asphalt, traffic noise decreased along all three roadways. However, once a sufficient amount of time had elapsed for the various roadways to be fully compacted, the roadways paved with rubberized asphalt still exhibited good traffic noise reduction, whereas the noise reduction of the conventional asphalt overlay was lost.

As stated previously, the Antelope Road test procedure was complicated in that the pre and post-paving tests were conducted on different roadway geometries. Because of this change in geometries, the noise reducing properties of the rubberized asphalt on that roadway may have been slightly understated as post-paving traffic was considerably closer to the measurement sites than pre-paving conditions. The changes in noise reduction of the rubberized asphalt on Alta Arden and Antelope noted between the tests conducted shortly after the paving and those conducted several months and years later (1 dB drop in noise reduction), is believed to be due to compaction of the roadway surfaces.

## **CONCLUSIONS OF THE STUDIES CONDUCTED IN SACRAMENTO COUNTY**

This analysis concludes that the use of rubberized asphalt on Alta Arden Expressway and Antelope Road resulted in a net decrease in traffic noise levels of approximately 4 dB over that provided by conventional asphalt. These conclusions hold for both the near and long-term conditions. The noise reduction provided by the rubberized paving was achieved predominately in the 500 to 4,000 Hertz frequency bands, which is consistent with the frequency character of tire noise.

These local test results, when considered with other studies conducted nationally and internationally, support the use of rubberized asphalt as a viable noise mitigation option. Its use could, in some cases, eliminate the need for noise barriers or reduce the heights of the barriers required to achieve satisfaction with local, state and federal noise standards.



---

It should be noted that the effectiveness of rubberized asphalt in reducing traffic noise levels would be highest on roadways with relatively low percentages of heavy duty trucks, as truck engine and exhaust stack noise is not believed to be substantially affected by rubberized paving.

## Appendix A Acoustical Terminology

## Appendix A - Acoustical Terminology

|                             |   |
|-----------------------------|---|
| <b>Acoustics</b>            | The science of sound.   |
| <b>Ambient Noise</b>        | The distinctive acoustical characteristics of a given space consisting of all noise sources audible at that location. In many cases, the term ambient is used to describe an existing or pre-project condition such as the setting in an environmental noise study. |
| <b>Attenuation</b>          | The reduction of an acoustic signal.  |
| <b>A-Weighting</b>          | A frequency-response adjustment of a sound level meter that conditions the output signal to approximate human response.   |
| <b>Decibel or dB</b>        | Fundamental unit of sound, A Bell is defined as the logarithm of the ratio of the sound pressure squared over the reference pressure squared. A Decibel is one-tenth of a Bell.   |
| <b>CNEL</b>                 | Community Noise Equivalent Level. Defined as the 24-hour average noise level with noise occurring during evening hours (7 - 10 p.m.) weighted by a factor of three and nighttime hours weighted by a factor of 10 prior to averaging.                               |
| <b>Frequency</b>            | The measure of the rapidity of alterations of a periodic signal, expressed in cycles per second or hertz.   |
| <b>L<sub>dn</sub></b>       | Day/Night Average Sound Level. Similar to CNEL but with no evening weighting.   |
| <b>L<sub>eq</sub></b>       | Equivalent or energy-averaged sound level.  |
| <b>L<sub>max</sub></b>      | The highest root-mean-square (RMS) sound level measured over a given period of time.  |
| <b>Loudness</b>             | A subjective term for the sensation of the magnitude of sound.  |
| <b>Masking</b>              | The amount (or the process) by which the threshold of audibility is for one sound is raised by the presence of another (masking) sound.   |
| <b>Noise</b>                | Unwanted sound.   |
| <b>Peak Noise</b>           | The level corresponding to the highest (not RMS) sound pressure measured over a given period of time. This term is often confused with the AMaximum@ level, which is the highest RMS level.   |
| <b>Threshold of Hearing</b> | The lowest sound that can be perceived by the human auditory system, generally considered to be 0 dB for persons with perfect hearing.  |
| <b>Threshold of Pain</b>    | Approximately 120 dB above the threshold of hearing.  |

Appendix B  
Noise Standards Commonly Applied in Sacramento County

## **Appendix B - Noise Standards Commonly Applied to Projects in Sacramento County**

### ***Sacramento County Noise Element Policies***

The Sacramento County Noise Element establishes land-use compatibility criteria for both interior and exterior areas of various land uses. The County Noise Element policies which pertain to transportation noise follow.

- NO-1:** Noise created by new transportation noise sources should be mitigated so as not to exceed 60-dB Ldn/CNEL at outdoor activity areas of any affected residential lands or land use situated in the unincorporated areas. When a practical application of the best available noise-reduction technology cannot achieve the 60-dB Ldn/CNEL standards, then an exterior noise level of 65-dB Ldn/CNEL may be allowed in outdoor activity areas.
  
- NO-4:** Where residential land uses are proposed in areas exposed or projected exterior noise levels exceeding 60 dB Ldn / CNEL or the performance standards described above, an acoustical analysis shall be required as part of the environmental review process.
  
- NO-6:** The compatibility of proposed nonresidential projects with existing and future noise levels due to transportation noise sources shall be evaluated through a comparison to the standards described in Table 5 (below) and Table II-3 found in the Sacramento County Noise Element of the General Plan.
  
- NO-7:** Proposed Development of Residential land uses should not be permitted in areas exposed to existing or project levels of noise from transportation which exceed 60 dB to 65 dB Ldn / CNEL unless the project design includes effective mitigation measures to reduce noise.

---

**Table 5**  
**Sacramento County Noise Element Noise Standards**

---

| <b>Land Use Category</b>         | <b>Exterior Noise Level Standard, Ldn</b> |                                 |
|----------------------------------|---|---------------------------------|
|                                  | <b>Acceptable</b>                         | <b>Conditionally Acceptable</b> |
| Residential                      | 60  | 75                              |
| Agriculture Residential          | 65  | 75                              |
| Churches                         | 60  | 70                              |
| Golf Courses                     | 75  | 80                              |
| Office/Commercial/Professional   | 65  | 75                              |
| Industrial/Utilities/Agriculture | 70  | 80                              |

Source: Sacramento County Noise Element

---

In addition to the Noise Element Noise Standards above, the General Plan Noise Element includes standards for acceptable noise levels for the interior spaces of noise-sensitive land uses affected by Transportation Noise. Those interior noise level standards are shown in Table 6.

---

**Table 6**  
**Acceptable Noise Levels In Unoccupied Rooms Affected By Transportation Noise**

---

| Location                         | Average Sound Level <sup>1</sup> dBA |
|----------------------------------|--------------------------------------|
| Radio studios, recording studios | 25-30                                |
| Music Rooms                      | 30-35                                |
| Concert halls, auditoriums       | 30-35                                |
| Theaters (speech)                | 30-35                                |
| Motion picture theaters          | 40-45                                |
| Churches                         | 35-40                                |
| Conference rooms, small offices  | 40-45                                |
| Classrooms                       | 35-45                                |
| Public offices, banks, stores    | 45-50                                |
| Hospitals                        | 40-45                                |
| Restaurants, cafeterias          | 45-50                                |
| Court rooms                      | 40-45                                |
| Libraries                        | 40-45                                |

1. Leq in worst-case hour during periods of use.

---

***California Environmental Quality Act Guidelines (CEQA)***

The California Environmental Quality Act guidelines state that transportation noise will have a significant impact if it "Increased substantially the ambient noise levels for adjoining areas". There are several criteria CEQA uses to assess the transportation noise impact on a project.

1. If the exposure of persons to or generation of noise levels result in an excess of standards established the local general plan or other applicable standards
2. If the project results in a substantial permanent increase in ambient noise levels in the project vicinity above levels existing without the project.
3. If the project results in substantial temporary or periodic increase in ambient noise levels in the project vicinity above levels existing without the project.

## ***Federal Policies***

The criteria for evaluating noise impacts that are used by the Federal Highway Administration and Caltrans are contained in the Caltrans Traffic Noise Analysis Protocol (the Protocol). The Protocol establishes Noise Abatement Criteria (NAC) for various land uses. Table 7 presents a summary of the Federal Noise Abatement Criteria.

---

**Table 7**  
**Federal Noise Abatement Criteria**  
**[Hourly A-Weighted Sound Level-decibels (dBA)<sup>1</sup>]**

---

| <b>Activity Category</b> | <b>Leq (h), dBA</b> | <b>L10(h), dBA</b> | <b>Activity Category Description</b>  |
|--------------------------|---------------------|--------------------|---|
| A                        | 57 (Exterior)       | 60 (Exterior)      | Lands on which serenity and quiet are of extraordinary significance and serve an important public need and where the preservation of those qualities is essential if the area is to continue to serve its intended purpose. |
| B                        | 67 (Exterior)       | 70 (Exterior)      | Picnic areas, recreation areas, playgrounds, active sports areas, parks, residences, motels, hotels, schools, churches, libraries, and hospitals.   |
| C                        | 72 (Exterior)       | 75 (Exterior)      | Developed lands, properties, or activities not included in Categories A or B above.   |
| D                        | C                   | C                  | Undeveloped Lands.  |
| E                        | 52 (Interior)       | 55 (Interior)      | Residences, motels, hotels, public meeting rooms, schools, churches, libraries, hospitals, and auditoriums.   |

---

<sup>1</sup> Either L10(h) or Leq(h) (but not both) may be used on a project.

---

Appendix C  
References Consulted



## References Consulted

1. *Environmental Noise Analysis, Alta Arden Expressway Resurfacing Project*, Brown-Buntin Associates, December 20, 1993.
2. *Environmental Noise Analysis, Rubberized Vs. Conventional Asphalt Overlays, Alta Arden Expressway and Bond Road*, Brown-Buntin Associates, November 20, 1995.
3. *Environmental Noise Analysis, Antelope Road Widening Project*, Brown-Buntin Associates, February 2, 1996.
4. *Mixed Roadway Surface Noise Measurement Results* prepared for The County of Orange (Report No. 91-191), by Mestre Greve Associates February 12, 1992.
5. *Noise Reduction with Asphalt-Rubber*, by Asphalt Rubber Producer Group, Washington D.C.
6. *Open Graded Rubberized Asphalt for Traffic Noise Reduction in Urban Areas*, by IR. J. C. P. Heerkens & DR. IR A. Von Meier, The Netherlands.
7. *Recycling Crumb Rubber Modified Pavements* (Research project 1333), by Texas Department of Transportation, November 1995.
8. *Rubberized asphalt reduced I-90 noise, official says*, Robert Will, Green Valley News & Sun, December 31, 199?.
9. *Sound Level Survey*. Tucson, Arizona. WT Job No. 7130K022. By Western Technologies INC. April 6, 1990.
10. *The Full scale Evaluation of Rubberized asphalt Concrete in British Columbia*, by Roger Johnson, James Sproule and Alan Juristovski, Canadian Technical Asphalt Association, Charlottetown B PEI, 1995.
11. *Asphalt Rubber Overlay Noise Study*, Acoustical Analysis Associates Inc., prepared for the City of Thousand Oaks, September 1992.
12. *The European Commission Green Paper*, Noise News International, June 1997.



EDMUND G. BROWN JR.  
GOVERNOR

STATE OF CALIFORNIA  
GOVERNOR'S OFFICE *of* PLANNING AND RESEARCH



KEN ALEX  
DIRECTOR

Received

AUG 16 2018

City of Stockton  
Community Development

August 10, 2018

David Stagnaro  
City of Stockton  
425 N El Dorado St  
Stockton, CA 95202

Subject: Envision Stockton 2040 General Plan Update and Utility Master Plan Supplements  
SCH#: 2017052062

Dear David Stagnaro:

The State Clearinghouse submitted the above named Draft EIR to selected state agencies for review. The review period closed on August 9, 2018, and no state agencies submitted comments by that date. This letter acknowledges that you have complied with the State Clearinghouse review requirements for draft environmental documents, pursuant to the California Environmental Quality Act.

Please call the State Clearinghouse at (916) 445-0613 if you have any questions regarding the environmental review process. If you have a question about the above-named project, please refer to the ten-digit State Clearinghouse number when contacting this office.

Sincerely,

Scott Morgan  
Director, State Clearinghouse

A14-01

**Document Details Report  
State Clearinghouse Data Base**

**SCH#** 2017052062  
**Project Title** Envision Stockton 2040 General Plan Update and Utility Master Plan Supplements  
**Lead Agency** Stockton, City of

**Type** EIR Draft EIR

**Description** The City of Stockton is preparing a comprehensive update to its existing General Plan. The update is expected to be completed in 2018 and will guide the city's development and conservation through 2040. The project also includes the preparation of Utility Master Plan Supplements (UMPS). The UMPS will consist of separate documents that will identify needed improvements to water, wastewater, and storm drainage facilities to serve anticipated development under the updated GP. The 2040 GP Update will include revision to the policies of the existing GP and consider changes to land use designation within the EIR Study Area where change or enhancement of existing uses is desired through 2040. The draft revision to the GP land use map will shrink the possible future footprint of the city by changing areas currently designated "village," which allows a variety of urban uses, to Open Space/Agriculture, including within the Delta Secondary Zone, where development is subject to Delta Protection Commission review. The City's Housing Element was recently updated and adopted by the City Council on April 12, 2016, and is not included as part of the proposed project. The overall purpose of the 2040 GP Update is to create a policy framework that articulates a vision for the city's long-term physical form and development, while preserving and enhancing the quality of life for Stockton's residents. The key components of this project will include broad community goals for the future of Stockton and specific policies and actions that will help meet the goals.

**Lead Agency Contact**

**Name** David Stagnaro  
**Agency** City of Stockton  
**Phone** (209) 937-8266 **Fax**  
**email**  
**Address** 425 N El Dorado St  
**City** Stockton **State** CA **Zip** 95202

**Project Location**

**County** San Joaquin  
**City** Stockton  
**Region**  
**Lat / Long**  
**Cross Streets**  
**Parcel No.**  

| <b>Township</b> | <b>Range</b> | <b>Section</b> | <b>Base</b> |
|-----------------|--------------|----------------|-------------|
|                 |              |                |             |

**Proximity to:**

**Highways** I-5, SR-99, SR 88, SR 12, etc  
**Airports** Stockton Metro, Kingdon, Lodi  
**Railways** UPRR, BNSF  
**Waterways** San Joaquin River, Calaveras River, San Joaquin Delta, SF Bay,  
**Schools** Various  
**Land Use** Various

**Project Issues** Archaeologic-Historic; Biological Resources; Drainage/Absorption; Economics/Jobs; Fiscal Impacts; Flood Plain/Flooding; Forest Land/Fire Hazard; Geologic/Seismic; Minerals; Noise; Population/Housing Balance; Recreation/Parks; Schools/Universities; Public Services; Septic System; Sewer Capacity; Soil Erosion/Compaction/Grading; Solid Waste; Toxic/Hazardous; Traffic/Circulation; Vegetation; Water Quality; Water Supply; Wetland/Riparian; Landuse; Cumulative Effects; Aesthetic/Visual; Agricultural Land; Air Quality; Growth Inducing

**Document Details Report  
State Clearinghouse Data Base**

---

**Reviewing Agencies** Resources Agency; Department of Fish and Wildlife, Region 2; Cal Fire; Department of Parks and Recreation; Department of Water Resources; Caltrans, Division of Aeronautics; California Highway Patrol; Caltrans, District 10; Office of Emergency Services, California; Department of Housing and Community Development; Native American Heritage Commission; Public Utilities Commission; Regional Water Quality Control Bd., Region 5 (Sacramento)

---

**Date Received** 06/26/2018      **Start of Review** 06/26/2018      **End of Review** 08/09/2018



Sent Via E-Mail  
August 10, 2018

David Stagnaro  
Planning Manager  
City of Stockton Community Development Department  
425 North El Dorado Street  
Stockton, California 95202  
David.Stagnaro@stocktonca.gov

RE: Envision Stockton EIR

Dear Mr. Stagnaro,

**FACILITIES**

Real Estate Management  
Physical Planning  
Space Management

3601 Pacific Avenue  
Stockton, California 95211  
Tel 209.946.2319

University of the Pacific has reviewed the *Envision Stockton 2040 General Plan Update and Utility Master Plan Supplements Draft EIR for the City of Stockton | Public Review | June 2018* document. The document and process have been thorough and represent a commitment of the City of Stockton and its staff to develop a General Plan Update that is responsive to the residents and stakeholders within the service area.

A15-01

The University has two comments and recommendations:

1. Proposed Land Use (Figure 3.3, Page 3-13): Parcels associated with University of the Pacific have been proposed as "Institutional" or "Residential". It is requested that all Pacific parcels be assigned the currently unused "University" designation rather than either "Institutional" or "Residential". Furthermore, Pacific staff would like to meet with City of Stockton staff and consultants, as appropriate, to discuss how this designation could be implemented.
2. Throughout the draft EIR there are policies, goals and/or actions that address impacts on construction activities. When these are based on existing regulations, statutes, laws, ordinances and/or other requirements, there are no concerns. It was not clear that all proposed policies, goals and/or actions are based upon these existing requirements. It was also unknown if input was solicited and received from builders and developers, both local to and doing work within the City of Stockton, who would be directly impacted by these policies, goals and/or actions. It is possible that some of these proposed policies, goals and/or actions may negatively impact (a) construction costs, (b) construction schedules, (c) competitiveness of local builders and/or developers, and/or (d) number of builders and/or developers interested in working within the City of Stockton. Construction and development are a key component of this General Plan Update and are important to the growth and sustainability of University of the Pacific. It is recommended that builder and developer groups be specifically asked to provide comments on this document.

A15-02

A15-03

University of the Pacific is grateful for the opportunity to review and provide comments on this General Plan Update. We look forward to continuing discussions with City staff, one of the University's critical local partners, as the Update is finalized.

Respectfully Submitted,

*Priscilla Meckley-Archuleta*

Priscilla Meckley-Archuleta  
Executive Director

From: Dean Plassaras <dplassaras@gmail.com >  
Sent: Thursday, July 19, 2018 1:21 Pm  
To: David Stagnaro <David.Stagnaro@stocktonca.gov >  
Subject: 2040 General Plan and the so-called "Education and Economic enterprise" zone

Dear David:

The proposed "Education and Economic enterprise zone" introduced in the 2040 General Plan draft fails to deliver the intended benefits. According to the consultants aiding the city in articulating such zoning designation, the aim is:

"Development in this designation is intended to support the City's economic development goals by attracting new businesses, industries, and/or educational institutions that provide high-quality jobs to the local workforce. By bringing major job-generators to Stockton, this designation supports the City's Economic Development Strategic Plan and State Executive Orders regarding greenhouse gas (GHG) reduction, Senate Bill (SB) 32, and the San Joaquin Sustainable Communities Strategy. Businesses envisioned for this designation include those within a Core Business Cluster industry, as specified in the City's Economic Development Strategic Plan, that provide a significant number of jobs offering wages averaging above Area Median Income, and that cannot be reasonably accommodated elsewhere within the city limit. In support of a major job-generator, this designation promotes linked transportation and housing options so that future employees can live close to their jobs and commute using transportation modes that support the City's vehicle miles traveled (VMT) reduction goals. Businesses that reduce VMT by providing vanpool programs, car share services, and active transportation alternatives are encouraged. The designation also allows proximate housing stock that supports the job generator, including single-family, multi-family, and/or mixed-use dwellings at various levels of affordability, with housing costs that generally correspond to the income levels of the jobs generated by the project. The City will negotiate with applicants to develop community benefit through development agreements that identify desired community amenities in the area of development and will ensure that development mitigates its environmental impacts as feasible, pursuant to the California Environmental Quality Act (CEQA). The maximum anticipated FAR is 0.6 and the maximum anticipated density is 24 dwelling units per gross acre; however, the designation allows variation from these standards with City approval to achieve the economic development goals and complete communities described above. Development proponents are encouraged to propose creative and innovative master plans to further the City's economic development goals consistent with the policies outlined above."

**B01-01**

Even though the above description might be a fine declaration of intent, it nevertheless falls short by entrapping the city in an unrealistic impressionist game of false expectations.

1. If the purpose of the 2040 GPis to bolster the vitality and dynamism of the downtown area and Stockton CBD, then it follows that such zoning belongs in areas much closer and/or part of downtown with much higher FAR possibilities rather than on the north side of 8 Mile Rd., which is a borderlands area and a hard city edge and not an incubator of better economic choices by an area facing serious enlargement constraints.

**B01-02**

2. The word "enterprise" when used in zoning matters implies heavy subsidies in the form of land and amenities needed by the Googles, Amazons, Teslas of this world; not to mention academic institutions which actually face constrained budgets and depend on very generous contributions, entailing free land and other substantial monetary outlays which are usually easily outbid by competing cities for the privilege of attracting same users.

3. This proposed zoning has the appearance of a bad political compromise, the proverbial "a camel is a horse designed by a committee" and lacks the seriousness which sophisticated players in real estate respond to in a positive way.

4. "Zoning is a complex set of regulations that municipalities use to control the use of all parcels of land in private ownership in their jurisdiction. It is clear that the original motivation for zoning was the control of negative externalities that arose in the largely unregulated urban land market of the early twentieth century. However, local officials and residents learned that zoning could also be used for fiscal and/or exclusionary purposes. This realization turns zoning into a topic that fits within the general category of the **economics of regulation**—in which regulations are adopted through a political process that operates to the apparent benefit of the group with the most influence over zoning decisions. "

5. "Most economists agree that there is a need for policies that mitigate negative external effects in urban areas, but they question whether zoning in its current versions is on balance good social and economic policy. This is a difficult question for which there is no definitive answer at this time."

In summary, this type of proposed zoning introduces uncertainty and confusion rather than clarity and demonstrable economic benefits (normally thought to be the creation of highest and best values for the community). Perhaps COS could set aside such public conversation until exogenous urban planning talent has been identified (award-winning national firm specialists ) and which is able to deliver on the topic of appropriate zoning; by definition the product of smart but attainable choices.

**B01-02  
cont.**

**B01-03**

Received

AUG 07 2018

City of Stockton  
Community Development



COMMENT CARD

Date: 8-1-18

Please fill out this form if you have any comments about the General Plan Update.  
(Name and contact information is optional).

Name: Colleen Foster  
Affiliation: Campaign for Common Ground  
Address: 4273 Boulder Creek Circle, Stockton, 95219  
Phone / Email: malialani@comcast.net

Comments (Use back if necessary):

① Public input CLEARLY opposes building homes north of 8 Mile Road. While I support flexibility for an employment generator north of 8 Mile Road, the General Plan needs TO BE CLEAR that homes will NOT be permitted in this Economic & Education Enterprise zone until AFTER an economic engine is secured. We do not want to open the door to the potential claim that if housing is built, an economic engine will be more likely to commit. This loophole is not consistent with Alternative C and specific language should be added to the General Plan to prevent this possible interpretation of the use of this zone.

B02-01

② The 2035 General Plan included the recommendation for a feasibility study re Inclusionary Housing ordinances. It is also included in this draft update. It is time to actually DO the study which should be undertaken separately from any discussion of Rent Stabilization or Just Cause Eviction.

B02-02



③ Page 3-22 (Under Land Use) has a section headed Fiscal Health is a Necessary Priority. However, the introduction to this section implies that since "a portion of sales tax from retail and business to business transactions goes directly to the General Fund, where it can be used to support services such as law enforcement, fire suppression and street maintenance" costs incurred by new development could be offset adequately by these revenues - but that has not historically been the case & it is unlikely to change in the future.

It would be more accurate & less misleading to include a bold statement that regardless of the quote above, new housing does not generate adequate revenue to support City services. A statement of this kind should be added to this section,

B02-03

## COMMENT LETTER # B03

**From:** Patrick Wall <wallpatrick@hotmail.com>  
**Sent:** Saturday, August 4, 2018 6:08 PM  
**To:** David Stagnaro <David.Stagnaro@stocktonca.gov>  
**Subject:** Stockton General Plan

No housing north of Eight Mile Road!

J. Patrick Wall  
1605 Academy Ct  
Stockton CA 95207

| B03-01

From: spectrald <102794@gmail.com>  
Sent: Monday, August 6, 2018 8:20 PM  
To: David Stagnaro <David.Stagnaro@stocktonca.gov>  
Subject: Envision Stockton EIR

Mr. Stagnaro:

I am deeply concerned and saddened by the knowledge of the changes that have taken place to our city's general plan update.

The potential plan is a travesty to future generations for multiple reasons. Primarily, the green space that now stands between Stockton and Lodi could so quickly be lost. Lost to urban sprawl. Our community should be considering building practices that encourage infill, sustainability, and not the reliance on automobiles.

Stockton's last general plan through 2035 did not include this distorted use of the land north of Eight Mile Road.

I implore you to do what is in your power to not allow the destruction of our city's northern green space boarder to be corrupted so frivolously.

Sincerely,

Justin Grant

1425 West Poplar Street

Stockton, CA 953203

**B04-01**

# COMMENT LETTER # B05

Comments on the DEIR

August 8, 2018

The Draft General Plan and the DEIR defines the newly re-named, non-specific “Economic and Education Enterprise” land use designation north of Eight Mile Road with a housing element of 26,710 units. This is inconsistent with the public workshops held over the last two years, where the majority favored the lands north Eight Mile Road for Agriculture/Open Space use.

After the close of public input, The City Council directed staff to consider an “extraordinary” opportunity on lands north of Eight Mile Road. The new General Plan could include a policy that recognizes this opportunity: “The City will consider future amendments to the General Plan for extraordinary growth plans outside the Urban Services Boundary that include significant job generators or public institutions such as a college campus.” There must be meaningful policies or restrictions on developing the land prematurely.

Notwithstanding that inclusion of this gross violation of the public trust with a developer led proposal which has had strong public opposition since 1990 when first proposed, the DEIR does not address any impacts.

The DEIR’s failure to analyze traffic and other impacts for projects assumed not to occur by 2040 (including the 3,800 acres north of Eight Mile Road) by promising that full environmental analysis and mitigation of impacts will be prepared if and when applications are submitted sometime in the future. This “piecemealing”, or segmenting of a project and the deferral of environmental analysis is specifically prohibited by the California Environmental Quality Act and more than forty years of case law.

This DEIR analysis has arbitrarily divided the buildout of the General Plan into two separate projects: the development that is assumed to occur by 2040, and the remaining development that is expected after that date. The downfall of the DEIR analysis is that the housing growth assumed by 2040 is 41,400 units, which is only one third of the total amount of housing allowed by the General Plan land use map (120,180 units). For non-residential growth, the discrepancy is even larger: only 17% of the 293,311,000 square feet of commercial and industrial is assumed by 2040. Thus, based on the housing projections alone, the traffic, air quality, public services and other environmental impacts of the buildout of the plan are potentially underestimated by two-thirds. The DEIR must analyze the impacts of the full level of residential, commercial, and industrial uses approved by the General Plan. The maximum level of development approved by the General Plan is the project being approved, not a “reasonably foreseeable” year 2040 scenario. Defining and analyzing “the whole of the project” being approved is a long-standing requirement under CEQA. The courts have consistently held that an EIR must examine a project’s potential to impact the environment, even if the development may not ultimately materialize. *Bozung v. Local Agency Formation Com.* (1975) 13 Cal.3d 263, 279, 282.

North of Eight Mile includes some remaining prime farmland and good farmland. This area is critical to maintain and create meaningful greenbelt space between Stockton and Lodi as described in the DGP 2040.

Respectfully,

Marjie Fries, Liaison for Environmental Justice and SJC Climate Action Coalition

B05-01

B05-02

B05-03

B05-04

APPENDIX B:  
WEST YOST WATER SUPPLY  
TECHNICAL MEMORANDUM







## TECHNICAL MEMORANDUM

DATE: September 13, 2018 Project No.: 425-10-16-04.007  
SENT VIA: EMAIL

TO: Tanya Sundberg

FROM: Doug Moore, PE, RCE #58122

REVIEWED BY: Mark Kubik, PE, RCE #50963

SUBJECT: Stockton General Plan Final EIR – Response to Water Supply Comments

## COMMENTS

This Technical Memorandum (TM) provides a brief response to several water supply comments on the Draft Environmental Impact Report (EIR), including Comments Nos. A13-50, A13-56, A13-57, A13-58, A13-60, and A13-62.

## RESPONSE

The response below is based on water supply, water demand, and wastewater evaluations provided in the following documents:

- *TM Stockton General Plan Update – Potable Water Master Plans Supplement (PVMPS)*, December 12, 2017 prepared for this Envision Stockton 2040 General Plan Update (GPU) by West Yost Associates (West Yost)
- *TM Stockton General Plan Update – Sewer Master Plan Supplement*, December 13, 2017 prepared for Envision Stockton 2040 GPU by West Yost
- City of Stockton (City) 2015 Urban Water Management Plan (COS UWMP), July 2016
- California Water Service – Stockton District 2015 Urban Water Management Plan (CWS-SD UWMP), June 2016

## Background

The City has developed the Delta Water Supply Project (DWSP) which began drawing water from the San Joaquin River in 2012. The objective of this supply is to achieve a long-term reliable water supply from the Delta for existing and future customers. The City has rights to Delta water because portions of the City of Stockton Water Service Area fall within the legally defined Delta and the area of origin. The City's water rights application addressed a long-term planning horizon through the year 2050, requesting an ultimate diversion of 160 million gallons per day (mgd), which is

equivalent to 125,900 acre-feet per year (afy). The State Water Resources Control Board (SWRCB) divided the water rights application into two separate applications: Application 30531A and 30531B. Application 30531A covers the initial phase of the DWSP up to 30 mgd (33,600 afy) and the place of use is confined to the 1990 General Plan boundary. The initial phase was granted a water right under California Water Code (CWC) Section 1485. The City has a permit from the SWRCB issued on March 8, 2006 for a 33,600 afy supply from the Sacramento/San Joaquin Delta.

The DWSP intake and water treatment plant was operational in 2012 with an initial capacity of 30 mgd (33,600 afy). The projected capacity of the DWSP by 2035 is 90 mgd with an annual production of approximately 50,000 afy. The DWSP will expand as needed up to 120 mgd, provided water rights are granted.

The City's supply from the San Joaquin River is curtailed annually from February through June of each year due to U.S. Department of Fish and Wildlife Service and California Department of Fish and Game restrictions. CWC Section 1485 Water Rights allows the City to take out of the Delta as much water as the City's wastewater treatment plant discharges into the Delta. This quantity, which fully covers the 33,600 afy, is not restricted as long as the same amount of wastewater is discharged into the Delta. CWC Section 1485 water may be subject to pumping restriction in some months due to fish protection.

### **Changes in Water Demands Resulting from Adoption of the Proposed General Plan**

Adoption of the proposed General Plan would result in changing the future growth from that planned under the 2035 General Plan to the growth planned in the Envision Stockton 2040 GPU. Relevant water demands are summarized below:

#### City of Stockton

- 2015 Total Water Demand: 26,319 afy (from Table 4-3 of the COS UWMP)
- 2035 Total Water Demand: 41,749 afy (from Table 6-5 of the COS UWMP)
- 2040 Total Water Demand: 44,465 afy (from Table 4-3 of the COS UWMP)
- 2040 Total Water Demand: 44,697 afy (from the PWMPS)

Thus, adoption of the Envision Stockton 2040 General Plan Update would increase future 2040 water demand in the City of Stockton from 41,749 afy to 44,697 afy; an increase of 2,948 afy.

#### California Water Service – Stockton District

- 2015 Total Water Demand: 22,090 afy (from Table 4-3 of the CWS-SD UWMP)
- 2035 Total Water Demand: 30,361 afy (from Table 6-5 of the CWS-SD UWMP)
- 2040 Total Water Demand: 30,740 afy (from Table 4-3 of the CWS-SD UWMP)
- 2040 Total Water Demand: 29,574 afy (from the PWMPS)

Thus, adoption of the Envision Stockton 2040 GPU would decrease of future 2040 water demand in the CWS-SD from 30,361 afy to 29,574 afy; a decrease of 787 afy.



### Comparison of Envision Stockton 2040 General Plan Update Water Demands and Available Water Supplies

Provided in Table 1 is a summary of the average day water demand estimated for the City under the proposed General Plan from the PWMPS and the available water supply, as reported in the COS UWMP. As shown, the estimated 2040 water demand is 39.9 mgd, which is equivalent to 44,697 afy. The COS UWMP projects that the available supply with only 33,600 afy taken from the Delta is 75,700 afy, leaving a potential surplus supply of 31,003 afy. The COS UWMP projects that the available supply with 50,000 afy taken from the Delta is 92,100 afy, leaving a potential surplus supply of 47,403 afy. Thus, there is adequate water supply for the 2040 growth under the proposed General Plan regardless of whether the City can draw a water supply of 33,600 or 50,000 afy from the Delta.

| <b>Table 1. City of Stockton Demand and Supply Summary</b> |                                       |                                       |  |  |
|--|---------------------------------------|---------------------------------------|--|--|
| Condition  | 2040 Water Demand from the PWMPS, mgd | 2040 Water Demand from the PWMPS, afy | 2040 Water Supply from the COS UWMP with the Delta Supply at 33,600 afy, afy | 2040 Water Supply from the COS UWMP with the Delta Supply at 50,000 afy, afy |
| 2040 GPU   | 39.9                                  | 44,697                                | 75,700   | 92,100   |

The TM *Stockton General Plan Update – Sewer Master Plan Supplement*, December 13, 2017 prepared for this GPU by West Yost indicates that the three-month average influent flow entering the Regional Wastewater Control Facility was reported to be 27.0 mgd for May through July 2017, which is a reasonable estimate of the 2017 wastewater Average Dry Weather Flow (ADWF). For treatment plant planning, the City has adopted a predicted future wastewater ADWF of 40.2 mgd for 2035 and 46.3 mgd for 2045. The City’s sewer system collects the wastewater from both the City and the CWS-SD water supply service areas. A 2040 ADWF of 43.2 mgd (48,394 afy) treated wastewater discharged to the Delta would result in the City being able to draw 48,394 afy of water supply from the Delta. Thus, it is likely the minimum allowable Delta water supply will be close to 50,000 afy.

Provided in Table 2 is a summary of the average day water demand estimated for the CWS-SD under the proposed General Plan from the PWMPS and the available water supply, as reported in the CWS-SD UWMP. As shown, the estimated Envision Stockton 2040 based water demand is 26.4 mgd, which is equivalent to 29,574 afy. The CWS-SD UWMP projects a water supply of 30,740 afy, leaving a potential surplus supply of 1,166 afy. Thus, there is adequate water supply for the Envision Stockton 2040 General Plan growth.

| <b>Table 2. California Water Service – Stockton District Demand and Supply Summary</b> |                                       |                                       |   |
|--|---------------------------------------|---------------------------------------|---|
| Condition  | 2040 Water Demand from the PWMPS, mgd | 2040 Water Demand from the PWMPS, afy | 2040 Water Supply from the CWS-SD UWMP, afy |
| 2040 GPU   | 26.4                                  | 29,574                                | 30,740                                      |

